

The Wood Collection

AFFORDABLE ENHANCED DESIGNS

VOLUME 53 - FEBRUARY 2015

TIMBER WOLF
FOREST PRODUCTS

"Leading the Pack"

"Leading the Pack"

As Unique



OUR MISSION STATEMENT

TIMBER WOLF FOREST PRODUCTS IS A NORTH CAROLINA BASED MANUFACTURER AND DISTRIBUTOR THAT EMBODIES THE IDEA OF DEVELOPING, MACHINING, AND DISTRIBUTING AN EXTENSIVE LINE OF COMPONENTS TO THE CABINET AND FURNITURE INDUSTRIES. WE ARE COMMITTED TO BRINGING THE BEST OF WOODWORKING TALENT, CUSTOM CAPABILITIES, AND THE INGENUITY OF CREATIVE DEVELOPMENT TO THE MARKETPLACE AT A COMPETITIVE PRICE. TIMBER WOLF RECOGNIZES AND CELEBRATES THAT OUR SUCCESS AS A BUSINESS AND INDIVIDUALS IS DEPENDENT ON OUR ABILITY TO MAINTAIN AND GROW OUR FAITH IN GOD.

ABOUT US...



TIMBER WOLF FOREST PRODUCTS HAS BEEN THE INDUSTRY'S FOREMOST SOURCE FOR FINE WOOD COMPONENTS SINCE OCTOBER OF 1998. FOUNDED BY RANDY D. ROPER, TIMBER WOLF FOREST PRODUCTS BEGAN ITS JOURNEY AS A COMPONENT PROVIDER TO LARGE FURNITURE MANUFACTURERS. AS THE FURNITURE INDUSTRY BEGAN TO OUTSOURCE OVERSEAS, TIMBER WOLF DIVERSIFIED INTO THE HOTEL AND HOSPITALITY, STORE FIXTURE, MILLWORK AND CABINET INDUSTRIES. OUR EXPERTISE WAS EAGERLY WELCOMED IN THESE NEW INDUSTRIES. RANDY, HIS WIFE, RITA AND THEIR CHILDREN, MADISON AND HOLLIE ARE ALL ACTIVELY INVOLVED WITH THE OPERATIONS AT TIMBER WOLF AND COLLECTIVELY BRING YEARS OF EXPERIENCE TO THE TABLE. WE USE THIS WORKING EXPERIENCE TO OFFER OUR CUSTOMERS EXCEPTIONAL VALUE AND QUALITY PARTS AT COMPETITIVE PRICES. WE ARE INDUSTRY RENOWN FOR OUR CRITICAL SANDING PROCESS THAT SERVES AS THE FOUNDATION FOR SUPERIOR FINISHES. WE ARE ACCUSTOMED TO MACHINING COMPLICATED PATTERNS INCLUDING ROPING, REEDING, FLUTING AND CARVING. TIMBER WOLF RESOLVES TO ALWAYS MANUFACTURE AS MANY COMPONENTS AS POSSIBLE IN OUR NORTH CAROLINA FACILITY. MOST IMPORTANTLY, WE ARE CONFIDENT THAT ONCE YOU USE TIMBER WOLF FOREST PRODUCTS YOU WILL SEE THAT BEING PART OF OUR FAMILY HAS ITS' BENEFITS. WE HAVE NO GREATER COMMITMENT THAN THE ULTIMATE SATISFACTION OF OUR CUSTOMERS.

About Us...

 American Made 

Phone: 877-504-WOLF
(9653)
sales@TimberWolfForest.com

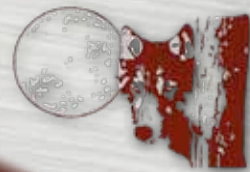

TABLE OF CONTENTS

■ About Us...	Page 2
■ Table of Contents	Page 3
■ Product Guides	Pages 4-16
■ Family Suites	Pages 17-91
■ Corbels, Brackets, Appliques & Onlays	Pages 92-111
■ 36" & 42" Legs & Posts	Pages 112-140
■ Corner Posts & Vanity Legs	Pages 141-144
■ Pedestal & Bun Feet	Pages 145-156
■ Furniture Legs	Pages 157-181
■ Cabriole & Queen Anne Legs	Pages 182-187
■ Extra Operations	Page 188
■ Species	Page 189
■ Custom Work	Pages 190-191
■ Notes	Page 192
■ Order Form	Page 193
■ Index by Series/Family Name	Page 194
■ Index by Series Number	Page 195

"Leading the Pack"

PRODUCTS AT A GLANCE PRODUCT GUIDE CORBELS & BRACKETS



Plain Brackets
Pages 4, 45, 93 & 95



Scalloped Brackets
Pages 4, 21, 39, 47, 55,
71, 81, 89, 93 & 95



Cove Brackets
Pages 4, 41, 73, 93 & 96



Lexington Brackets
Pages 4, 27, 59, 93 & 96



Providence Brackets
Pages 4, 31, 43, 49,
69, 75, 93 & 97



Cortez Brackets
Pages 4, 29, 93 & 97



Mission Brackets
Pages 4, 83, 93 & 98



Nantucket Brackets
Pages 4, 35, 51, 67, 93 & 98



Manchester Brackets
Pages 4, 23, 33, 61,
79, 85, 93 & 99

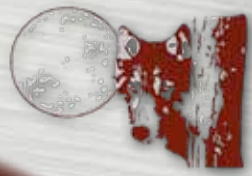

PRODUCTS AT A GLANCE
PRODUCT GUIDE

**TRIM-TO-FIT HOOD, MANTEL &
ISLAND CORBELS & BRACKETS**



Houston
Page 94 & 100



Plain
Page 95 & 100



Scalloped
Page 95 & 101



Cove
Page 96 & 101



Lexington
Page 96 & 101



Providence
Page 97 & 101



Cortez
Page 97 & 101



Mission
Page 98 & 101



Nantucket
Page 98 & 101



Manchester
Page 99 & 101

"Leading the Pack"

PRODUCTS AT A GLANCE PRODUCT GUIDE ACANTHUS CORBELS



*Standard Profile Corbels
Pages 6, 19 & 103*



*Standard Profile Corbels
Pages 6, 19 & 103*



*Low Profile Corbels
Pages 6, 19 & 103*



*Low Profile Corbels
Pages 6, 19 & 103*



*Standard Profile Corbels
Pages 6, 19 & 103*



*Standard Profile Corbels
Pages 6, 19 & 103*



*Standard Profile Corbels
Pages 6, 19 & 102*

*Low Profile Corbels
Pages 6, 19 & 102*

Phone: 877-504-WOLF
(9653)
sales@TimberWolfForest.com

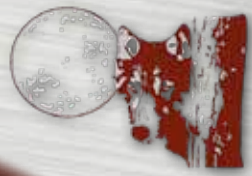

PRODUCTS AT A GLANCE

PRODUCT GUIDE

TRADITIONAL CORBELS



CBL-PT3

Traditional Standard Profile Corbels
Pages 7, 31, 43, 49, 53, 69, 75, 91, 93, & 107



CBL-PT2



CBL-PT1



CBL-PT4

Traditional Standard Profile Corbel
Pages 7, 23, 31, 37, 43, 49, 53, 55, 63, 69, 71, 75, 89, 91, 93 & 107



CBL-PT5

Traditional Low Profile Corbel
Pages 7, 23, 31, 37, 43, 45, 49, 53, 55, 63, 69, 71, 75, 89, 91, 93 & 107



CBL-WC13

Traditional Standard Profile Corbel Pages 7, 45, 93 & 107



CBL-001-L



CBL-001-M



CBL-001-S

Traditional Standard Profile Corbels
Pages 7, 23, 37, 47, 55, 62, 71, 77, 89, 93 & 107



CBL-WC12



CBL-WC12.4.5



CBL-WC12.5.75

Traditional Standard Profile Corbels
Pages 7, 21, 25, 33, 39, 45, 47, 51, 53, 63, 77, 79, 93 & 107



CBL-WC12F



CBL-VT149



CBL-VT153



CBL-VT159



CBL-VT158



CBL-VT174



CBL-VT170

Traditional Standard Profile Corbels
Page 7, 37, 77, 93 & 106



CBL-VT178



CBL-VT179



CBL-VT180



CBL-VT181

Traditional Low Profile Corbels
Page 7, 106



CBL-VT182

"Leading the Pack"

PRODUCTS AT A GLANCE

PRODUCT GUIDE

MISSION CORBELS



CBL-PM2
CBL-PM1
Standard Profile Corbels
Pages 8, 65, 93 & 104

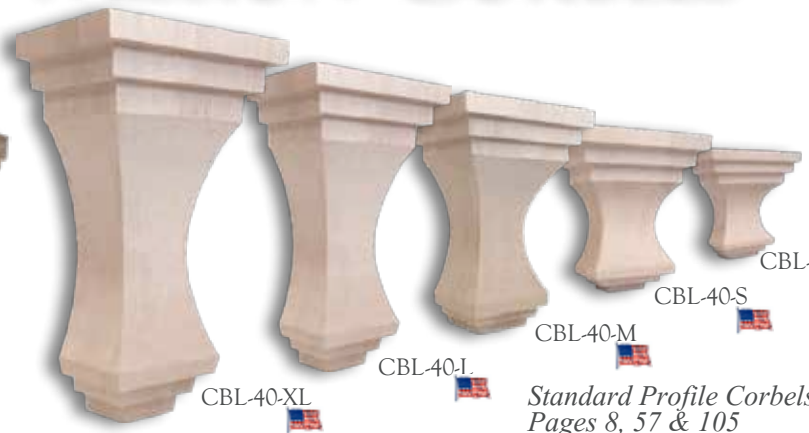

CBL-40-XL
CBL-40-L
CBL-40-M
CBL-40-S
CBL-40-XS
Standard Profile Corbels
Pages 8, 57 & 105



CBL-WC22
Standard Profile Corbels
Pages 8, 65, 93 & 104

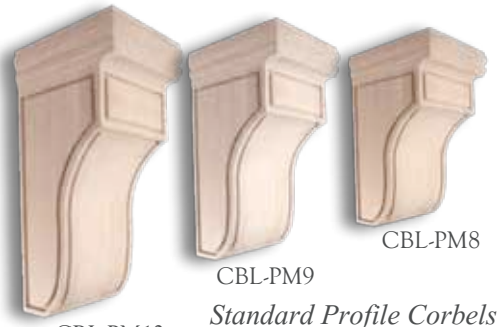

CBL-PM10
CBL-PM9
CBL-PM8
Standard Profile Corbels
Pages 8, 65, 93 & 105

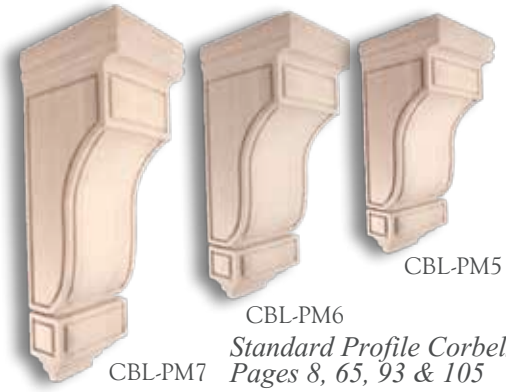

CBL-PM7
CBL-PM6
CBL-PM5
Standard Profile Corbels
Pages 8, 65, 93 & 105



CBL-PM4
Standard Profile Corbels
Pages 8, 65, 93 & 104



CBL-004-XL
CBL-004-L
CBL-004-M
CBL-004-S
CBL-004-XS
Standard Profile Corbels
Pages 8, 65, 93 & 103



CBL-VM430
CBL-VM429
CBL-VM428
CBL-VM427
CBL-VM426
Standard Profile Corbels
Page 8, 65, 67, 83, 93 & 105

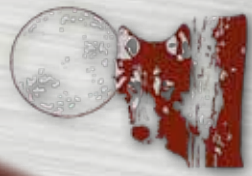

PRODUCTS AT A GLANCE PRODUCT GUIDE

CORBELS, BRACKETS & ONLAYS



CBL-002-M
Transitional
Standard Profile
Pages 9, 53, 87,
93 & 108



CBL-003-M
Transitional
Standard Profile
Pages 9, 53, 87,
93 & 108



CBL-006-M
Transitional
Standard Profile
Pages 9, 29, 61,
93 & 108



CBL-007-M
Transitional
Standard Profile
Pages 9, 29, 93
& 108



CBL-008-M
Transitional
Standard Profile
Pages 9, 29, 93
& 108



CBL-WC16
Transitional
Standard Profile
Pages 9, 39, 93
& 108



CRV-VR071
Applique
Pages 9, 18,
93 & 109



CRV-VR072
Applique
Pages 9, 18,
93 & 109



CRV-VR099
Applique
Pages 9, 18,
93 & 109

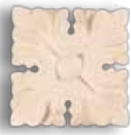

CRV-VR097
Applique
Pages 9, 18,
93 & 109



CRV-VC260
Applique
Pages 9, 18,
93 & 109



CRV-VC261
Applique
Pages 9, 18,
93 & 109



CRV-VC260
Applique
Pages 9, 18,
93 & 109



CRV-VC343
Applique
Pages 9, 18,
93 & 109



CRV-VC344
Applique
Pages 9, 18,
93 & 109



CRV-VR562-S
Applique
Pages 9, 18,
93 & 109



CRV-VR562-M
Applique
Pages 9, 18,
93 & 109



CRV-VR562-L
Applique
Pages 9, 18,
93 & 109



CRV-VR588
Applique
Pages 9, 18,
93 & 109



CRV-VR587
Applique
Pages 9, 18,
93 & 109



TW-PB9
Plythe Block
Pages 9, 93 &
111



TW-R8
Rosette
Pages 9, 93
& 111



ONL-V156
Onlay
Pages 9, 18, 93 & 111



ONL-V182
Onlay
Pages 9, 18, 93 & 111



ONL-1S-20



ONL-1M-24



ONL-2S-20



ONL-2M-24



ONL-1L-36



ONL-2L-36

Onlay
Pages 9, 18, 93 & 110

Onlay
Pages 9, 18, 93 & 110

"Leading the Pack"

PRODUCTS AT A GLANCE PRODUCT GUIDE

36" & 42" LEGS & POSTS



Acanthus Series
31000
Pages 10, 18, 113 & 114



Bellington Series
24000
Pages 10, 20, 113 & 114



Branson Series
8000C
Pages 10, 22, 24, 113, 115 & 116



Cabriole Series
Pages 10, 113 & 117



Cathedral Series
Pages 10, 113, 118 & 142



Charleston Series
14000
Pages 10, 26, 113 & 119



Cosmo Series
3000
Pages 10, 28, 113 & 120



Dellinger Series
10000
Pages 10, 30, 113 & 121



Dillon Series
27000
Pages 10, 32, 113 & 121



Ellis Series
28000
Pages 10, 34, 113 & 122



Empire Series
18000
Pages 10, 36, 113 & 122

American Made

Phone: 877-504-WOLF
(9653)
sales@TimberWolfForest.com

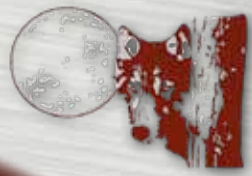

PRODUCTS AT A GLANCE
PRODUCT GUIDE

36" & 42" LEGS & POSTS



Essential Series

TW

Pages 11, 38, 113 & 123

Essential Series

TW

Pages 11, 38, 113 & 123

Essential Series

TW

Pages 11, 38, 113 & 123

Franklin Series

34000

Pages 11, 40, 113 & 123

Georgian Series

41000

Pages 11, 42, 113 124 & 163

Hamilton Series

4000

Pages 11, 44, 113 & 124



Harvest Series

2000

Pages 11, 46, 113 & 125

Jamestown Series

1000

Pages 11, 48, 113 & 126

Jebella Series

HB

Pages 144

Kimerick Series

30000

Pages 11, 50, 113 & 126

Kingston Series

5000

Pages 11, 52, 113 & 127



"Leading the Pack"

PRODUCTS AT A GLANCE PRODUCT GUIDE

36" & 42" LEGS & POSTS



Lakeland Series
38000
Pages 12, 54,
113 & 127



Liberty Series
40000
Pages 12, 56,
113 & 128



Lincoln Series
6000
Pages 12, 58,
113 & 129



Livingston Series
17000
Pages 12, 60,
113 & 129



Madison Series
8000
Pages 12, 62,
113 & 130



Mission Series
22000
Pages 12, 64,
113 & 131



Monaco Series
21000
Pages 12, 66,
113 & 132



Monte Cristo Series
11000
Pages 12, 68,
113 & 132



Rochester Series
32000
Pages 12, 70,
113 & 133



Roosevelt Series
36000
Pages 12, 72,
113 & 133



Salem Series
19000
Pages 12, 74,
113 & 134



Santa Fe Series
20000
Pages 12, 76,
113 & 135

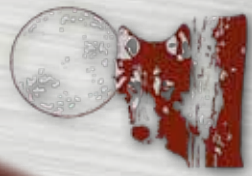

PRODUCTS AT A GLANCE
PRODUCT GUIDE

36" & 42" LEGS & POSTS



Savannah Series
 7000
 Pages 13, 78, 113 & 136



Shaker Series
 98000
 Pages 13, 80, 113 & 137



Skyline Series
 99000
 Pages 13, 82, 113 & 137



Truman Series
 42000
 Pages 13, 113 & 138



Vanderbilt Series
 16000
 Pages 13, 84, 113 & 138



Victoria Series
 15000
 Pages 13, 86 113 & 139



Williamsburg Series
 12000
 Pages 13, 88, 113 & 140



Winston Series
 9000
 Pages 13, 90, 113 & 140



Vanity Series HB
 Pages 13, 113 & 143



Vanity Series HB
 Pages 13, 113 & 143



"Leading the Pack"

PRODUCTS AT A GLANCE

PRODUCT GUIDE

BUN FEET



ML1101F
Pages 74, 76, 86, 146 & 151



QAN7-CP
Pages 156 & 187



CAB300-6
Pages 117, 146, 156 & 184



BFS14S
Pages 27, 119, 146 & 152



BFS14L
Pages 27, 119, 146 & 152



BFS22S
Pages 65, 131, 146 & 152



BFS22L
Pages 65, 131, 146 & 152



BFS41S
Pages 42, 146 & 150



BFS41L
Pages 42, 146 & 150



BF401-C
Pages 56, 84, 128, 146 & 152



BF402-C
Pages 56, 84, 128, 146 & 152



BF403-C
Pages 56, 146 & 152



BF225-40
Pages 28, 80, 146 & 155



BF225-60
Pages 28, 146 & 155



BF801
Pages 82, 137, 146 & 154



BF802
Pages 28, 80, 82, 146 & 154



BF803
Pages 60, 66, 80, 82, 146 & 154



BF805
Pages 60, 66, 80, 82, 146 & 154



BF820
Pages 28, 80, 82, 137, 146 & 154



BF821
Pages 28, 80, 82, 146 & 154



BF822
Pages 146 & 154



BF900
Pages 36, 40, 63, 72, 78, 133, 146 & 149



BF901
Pages 36, 40, 63, 72, 78, 133, 146 & 149



BF902
Pages 42, 54, 59, 146 & 149



BF903
Pages 36, 44, 50, 146 & 149



BF904-C
Pages 32, 34, 60, 84, 146 & 152



BF910
Pages 36, 52, 68, 78, 146 & 149



BF911
Pages 36, 52, 68, 78, 146 & 149



BF912
Pages 36, 50, 52, 68, 78, 122, 132, 146 & 149



BF913
Pages 20, 36, 44, 50, 54, 68, 70, 72, 78, 86, 88, 114, 122, 132, 146 & 149



BF914-C
Pages 32, 34, 60, 66, 122, 132, 146, & 152

American Made

Phone: 877-504-WOLF
(9653)
sales@TimberWolfForest.com

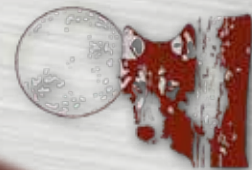

PRODUCTS AT A GLANCE PRODUCT GUIDE

BUN FEET



BF916
Pages 46, 86,
146 & 150



BF918-C
Pages 60, 66,
84, 146 & 152



BF919
Pages 30, 38, 42, 48,
70, 74, 76, 88, 90, 121,
133, 134, 146 & 150



BF920-C
Pages 32, 60,
66, 121 & 146



BF925
Pages 30, 36, 52, 59,
63, 68, 74, 76, 78,
136, 146 & 150



BF926-C
Pages 32, 34,
84, 146 & 153



BF927-C
Pages 32, 34, 84,
138, 146 & 153



BF928-C
Pages 22, 60,
115, 146 & 153



BF929-C
Pages 22, 60,
115, 146 & 153



BF930
Pages 40, 52, 54,
146 & 150



BF931
Pages 44, 146
& 150



BF940
Pages 44, 52,
146 & 150



BF945
Pages 38, 46, 63, 86,
123, 130, 146 & 150



BF950
Pages 42, 146
& 150



BF951
Pages 48, 126,
146 & 150



BF952
Pages 30, 74, 76,
86, 90, 146 & 151



BF953
Pages 40, 44, 52,
146 & 151



BF958-C
Pages 22, 34, 66,
122, 146 & 153



BF959-C
Pages 22, 34, 66,
122, 146 & 153



BF960
Pages 20, 30, 46, 48, 54, 59,
63, 68, 70, 74, 76, 88, 90,
125, 129, 134, 146 & 151



BF961-C
Pages 22, 34, 60, 66,
122, 146 & 153



BF962-C
Pages 22, 34, 60, 66,
84, 122, 146 & 153



BF963
Pages 20, 30, 38, 46, 48, 54,
59, 63, 68, 70, 74, 76, 88,
90, 125, 134, 146 & 151



BF965-C
Pages 65, 84, 131,
138, 146 & 153



BF966
Pages 30, 38, 40, 42,
63, 72, 74, 76, 86, 90,
123, 133, 146 & 151

"Leading the Pack"

PRODUCTS AT A GLANCE

PRODUCT GUIDE

BUN FEET & PEDESTAL FEET



BF975
Pages 70, 72,
88, 146 & 151



BF983
Pages 38, 50,
52, 59, 68, 78,
136, 146 & 151



BF990
Pages 50, 146
& 151



BF992-C
Pages 27, 119,
146 & 153



BF993-C
Pages 27, 119,
146 & 153



BF-P002
Pages 38, 44,
46, 54, 63, 70,
88, 90, 133, 146
& 151



PFC-CS-4 &
PFC-CS-4.5
Pages 24, 146
& 147



PFC-LC-4 &
PFC-LC-4.5
Pages 24, 146
& 147



PFC-RC-4 &
PFC-RC-4.5
Pages 24, 146
& 147



PFC-LS-4 &
PFC-LS-4.5
Pages 24, 146
& 147



PFC-RS-4 &
PFC-RS-4.5
Pages 24, 146
& 147



PFP-PED-L
Pages 16 & 148



PFP-PED-C
Pages 16 & 148



PFP-PED-CR
Pages 16 & 148



PFP-PED-R
Pages 16 & 148



PFP-PED-M
Pages 16 & 148



PFP-PED-2-L
Pages 16 & 148



PFP-PED-2-C
Pages 16 & 148



PFP-PED-2-R
Pages 16 & 148



PFP-PED-2-M
Pages 16 & 148

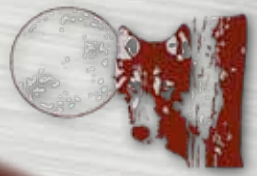

HARMONIZE YOUR KITCHEN
& BRING IT ALL TOGETHER
WITH OUR
FAMILY SUITES



Liberty Family
Shown in Picture

"Leading the Pack"

ACANTHUS FAMILY

Post, Appliques & Onlays

Family Suites

Fluted Acanthus
5"



36"

ISL31500FA

Item No.	Tall	Width	Top Shank Length	Bottom Shank Length
ISL31500FA	36"	5"	7-11/16"	7-11/16"

Available in Alder, Cherry, Maple, Red Oak & Rubberwood



ONL-1S-20

ONL-1M-24



ONL-1L-36

Item No.	Tall	Deep	Wide
ONL-1L-36	7-1/2"	7/8"	36"
ONL-1M-24	5"	3/4"	24"
ONL-1S-20	4"	3/4"	20"

Available in Alder, Cherry, Maple, Red Oak & Rubberwood

7-11/16"



ONL-2S-20

ONL-2M-24



ONL-2L-36

Item No.	Tall	Deep	Wide
ONL-2L-36	7-1/2"	7/8"	36"
ONL-2M-24	5"	3/4"	24"
ONL-2S-20	4-1/4"	3/4"	20"

Available in Alder, Cherry, Maple, Red Oak & Rubberwood



ONL-V182



ONL-V156

Item No.	Tall	Deep	Wide
ONL-V156	4-1/4"	7/16"	17-5/8"
ONL-V182	2-3/4"	5/8"	7-1/2"

Available in Poplar, Maple, & Oak



CRV-VR071



CRV-VR097



CRV-VR099



CRV-VR588



CRV-VR587

7-11/16"



CRV-VR562-S



CRV-VR562-M



CRV-VR562-L



CRV-VR072

Item No.	Tall	Deep	Wide
CRV-VR071	2-1/4"	3/8"	2-1/4"
CRV-VR072	3-1/8"	3/8"	3-1/8"
CRV-VR097	3-1/2"	3/4"	3-1/2"
CRV-VR099	3-1/2"	3/4"	3-1/2"
CRV-VC260	3"	7/8"	3"
CRV-VC261	6"	7/8"	6"
CRV-VC262	8"	15/16"	8"
CRV-VC343	4"	1-5/8"	3-1/2"
CRV-VC344	5-1/4"	2"	4-3/4"
CRV-VR562-S	4-3/8"	5/8"	2-3/4"
CRV-VR562-M	6-1/2"	7/8"	4-1/8"
CRV-VR562-L	10-3/4"	7/8"	6-5/8"
CRV-VR587	5"	1/2"	5"
CRV-VR588	5"	1/2"	5"



CRV-VC262



CRV-VC343



CRV-VC344

Available in Aspen, Alder, Cherry, Maple, & Oak

Phone: 877-504-WOLF
(9653)
sales@TimberWolfForest.com



ACANTHUS FAMILY

Corbels

Family Suites



Standard Profile Corbels

Item No.	Tall	Deep	Wide
CBL-PA1	10"	5-1/4"	4-5/8"
CBL-PA2	14"	7"	5"
CBL-PA3	22"	7-3/4"	6-3/4"

Available in Alder, Cherry, Maple, Red Oak & Rubberwood



Standard Profile Corbels

Item No.	Tall	Deep	Wide
CBL-PA4	13"	7-3/4"	3-1/2"

Available in Alder, Cherry, Maple, Red Oak & Rubberwood

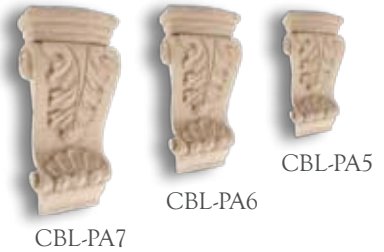

Low Profile Corbels

Item No.	Tall	Deep	Wide
CBL-PA5	6"	1-3/8"	2-3/4"
CBL-PA6	8"	1-1/2"	3-1/2"
CBL-PA7	10"	1-3/4"	4-1/2"

Available in Alder, Cherry, Maple, Red Oak & Rubberwood



Low Profile Corbels

Item No.	Tall	Deep	Wide
CBL-PA8	4-1/4"	1-3/4"	3"
CBL-PA9	4-1/2"	1-1/2"	2-3/4"
CBL-PA10	5-1/2"	1-1/4"	3-1/2"
CBL-PA11	7"	2"	4-1/2"

Available in Alder, Cherry, Maple, Red Oak & Rubberwood



Standard Profile Corbels

Item No.	Tall	Deep	Wide
CBL-WC10	14"	7-5/16"	5"

Available in Rubberwood Only



Standard Profile Corbels

Item No.	Tall	Deep	Wide
CBL-WC14	13"	9"	2-1/2"

Available in Rubberwood Only

CBL-WC14

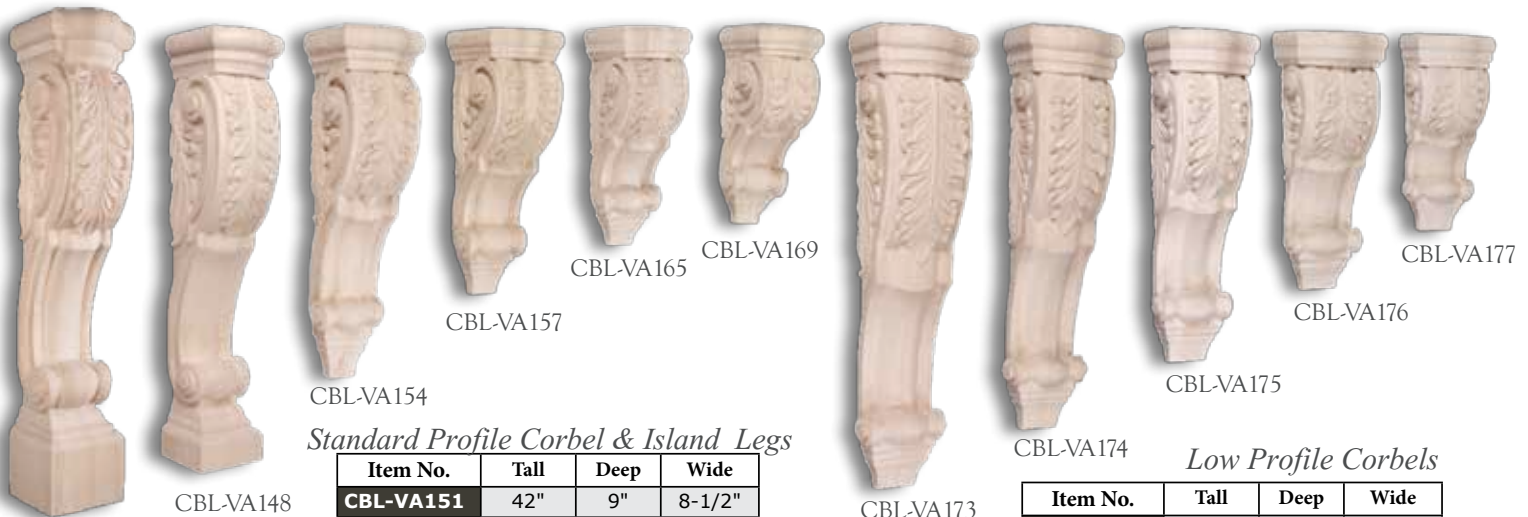

Standard Profile Corbel & Island Legs

Item No.	Tall	Deep	Wide
CBL-VA151	42"	9"	8-1/2"
CBL-VA148	36"	8"	7-1/2"
CBL-VA154	26-1/2"	7-1/2"	7"
CBL-VA157	18-1/2"	7"	5-7/8"
CBL-VA165	14"	5-3/4"	5"
CBL-VA169	10-1/2"	5"	3-7/8"

Available in Alder, Aspen, Cherry, Maple & Oak

Low Profile Corbels

Item No.	Tall	Deep	Wide
CBL-VA173	34"	5-3/4"	8-1/2"
CBL-VA174	28"	5"	7-1/2"
CBL-VA175	22"	4-1/2"	7"
CBL-VA176	14-5/8"	3-3/4"	6"
CBL-VA177	10"	2-1/2"	4-1/2"

Available in Alder, Aspen, Cherry, Maple & Oak



"Leading the Pack"

BELLINGTON FAMILY

Family Suites

Plain Round

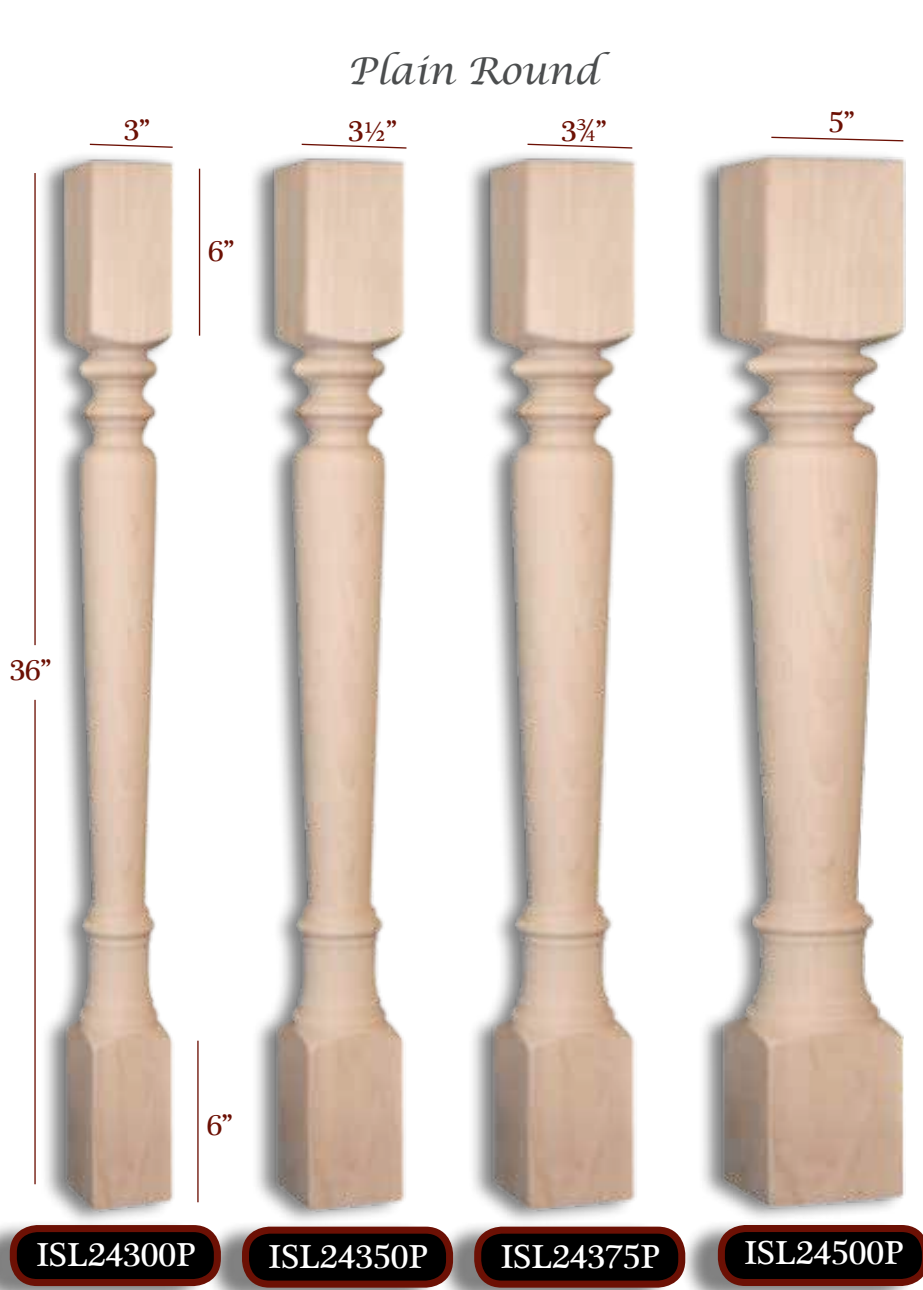

Available in Alder, Cherry, Maple, Poplar, Red Oak & Rubberwood
Other Species upon request

Available in Alder, Cherry, Maple, Poplar, Red Oak, Rubberwood & White Pine
Other Species upon request

Item No.	Tall	Width	Top Shank Length	Bottom Shank Length
ISL24300P	36"	3"	6"	6"
ISL24350P	36"	3-1/2"	6"	6"
ISL24375P	36"	3-3/4"	6"	6"
ISL24500P	36"	5"	6"	6"

Item No.	Tall	Overall Width	Toe
BF913	9-1/8"	3-3/8"	7/8"
BF960	4-1/2"	3-1/2"	1-1/2"
BF963	4"	3-1/2"	1-1/2"

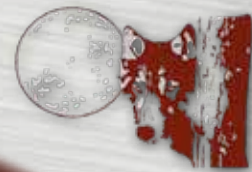

BELLINGTON FAMILY

Family Suites

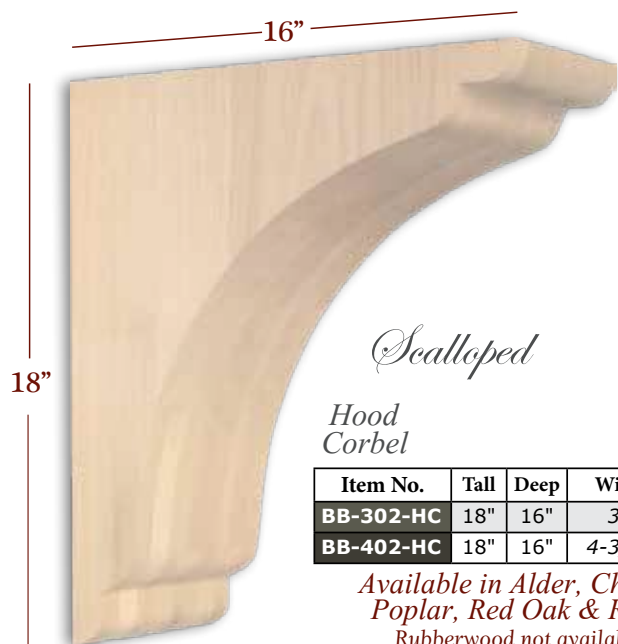

Scalloped

Hood Corbel

Item No.	Tall	Deep	Wide	Description
BB-302-HC	18"	16"	3"	Hood Corbel
BB-402-HC	18"	16"	4-3/4"	Hood Corbel

Available in Alder, Cherry, Maple, Poplar, Red Oak & Rubberwood
 Rubberwood not available in 4-3/4"
 Other Species available upon request



Scalloped

Overhang Bracket

Item No.	Tall	Deep	Wide	Description
BB-002-OH	10"	10"	1-3/4"	Overhang
BB-302-OH	10"	10"	3"	Overhang
BB-402-OH	10"	10"	4-3/4"	Overhang

Available in Alder, Cherry, Maple, Poplar, Red Oak & Rubberwood
 Rubberwood not available in 4-3/4"
 Other Species available upon request

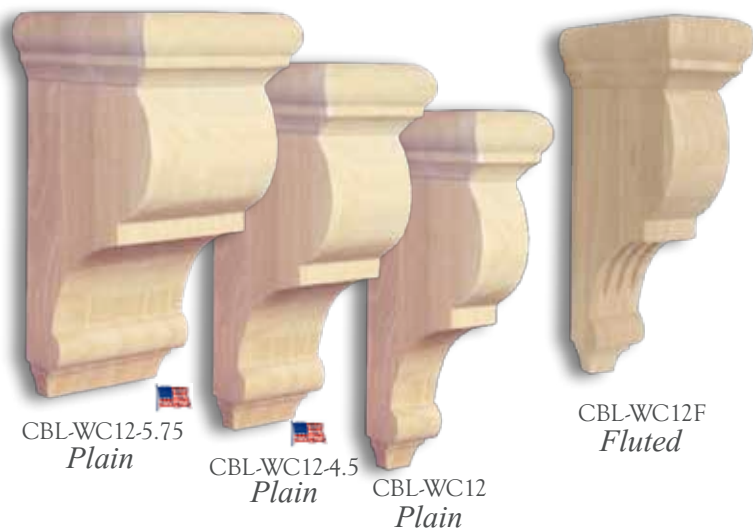

CBL-WC12-5.75
Plain

CBL-WC12-4.5
Plain

CBL-WC12
Plain

CBL-WC12F
Fluted

Item No.	Description	Tall	Deep	Wide
CBL-WC12	Plain	12"	6-1/2"	3"
CBL-WC12-4.5	Plain	12"	6-1/2"	4-1/2"
CBL-WC12-5.75	Plain	12"	6-1/2"	5-3/4"
CBL-WC12F	Fluted	12"	6-1/2"	3"

Available in Alder, Cherry, Maple, Red Oak & Rubberwood

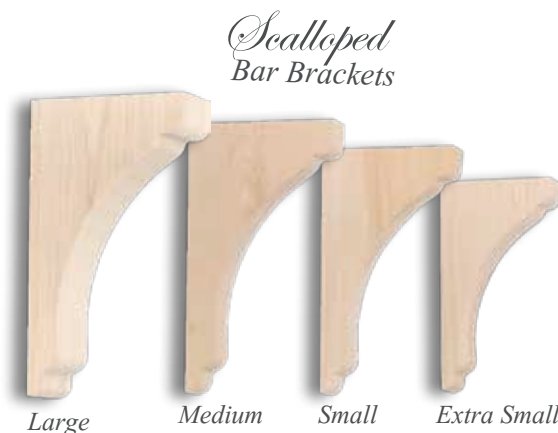

Scalloped
Bar Brackets

Large

Medium

Small

Extra Small

	Item No.	Tall	Deep	Wide	Description
1-3/4" W	BB-002-L	14-5/32"	8"	1-3/4"	Large
	BB-002-M	10-5/8"	5-1/2"	1-3/4"	Medium
	BB-002-S	9"	5"	1-3/4"	Small
	BB-002-XS	7-3/16"	4"	1-3/4"	Extra Small
3" W	BB-302-L	14-5/32"	8"	3"	Large
	BB-302-M	10-5/8"	5-1/2"	3"	Medium
	BB-302-S	9"	5"	3"	Small
	BB-302-XS	7-3/16"	4"	3"	Extra Small
4-3/4" W	BB-402-L	14-5/32"	8"	4-3/4"	Large
	BB-402-M	10-5/8"	5-1/2"	4-3/4"	Medium
	BB-402-S	9"	5"	4-3/4"	Small
	BB-402-XS	7-3/16"	4"	4-3/4"	Extra Small

Available in Alder, Cherry, Maple, Poplar, Red Oak & Rubberwood
 Rubberwood not available in 4-3/4"
 Other Species available upon request

"Leading the Pack"

BRANSON FAMILY

Family Suites

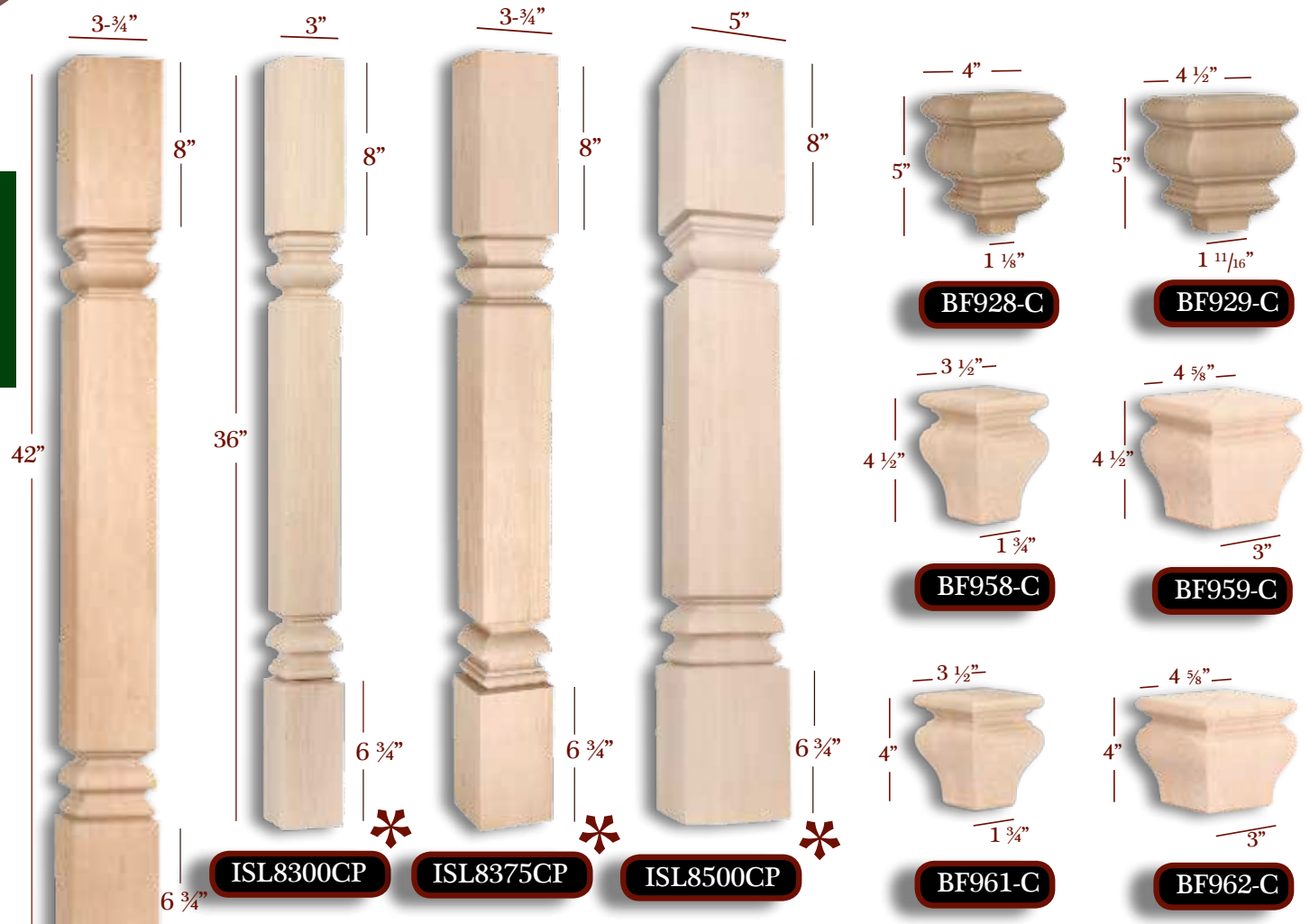

* Branson Family Posts available in 36" & 42" tall & 3", 3-1/2", 3-3/4" & 5" sq.

BAR8375CP

Available in Alder,
Cherry, Maple,
Red Oak & Rubberwood
Other Species upon
request

Item No.	Description	Tall	Width	Top Shank Length	Bottom Shank Length	Toe
ISL8300CP	PLAIN SQUARE POST	36"	3"	8"	6-3/4"	N/A
ISL8350CP	PLAIN SQUARE POST	36"	3-1/2"	8"	6-3/4"	N/A
ISL8375CP	PLAIN SQUARE POST	36"	3-3/4"	8"	6-3/4"	N/A
ISL8500CP	PLAIN SQUARE POST	36"	5"	8"	6-3/4"	N/A
BAR8300CP	PLAIN SQUARE POST	42"	3"	8"	6-3/4"	N/A
BAR8350CP	PLAIN SQUARE POST	42"	3-1/2"	8"	6-3/4"	N/A
BAR8375CP	PLAIN SQUARE POST	42"	3-3/4"	8"	6-3/4"	N/A
BAR8500CP	PLAIN SQUARE POST	42"	5"	8"	6-3/4"	N/A
BF928-C	SQUARE BUN FOOT	5"	4"	N/A	N/A	1-1/8"
BF929-C	SQUARE BUN FOOT	5"	4-1/2"	N/A	N/A	1-11/16"
BF958-C	SQUARE BUN FOOT	4-1/2"	3-1/2"	N/A	N/A	1-3/4"
BF959-C	SQUARE BUN FOOT	4-1/2"	4-5/8"	N/A	N/A	3"
BF961-C	SQUARE BUN FOOT	4"	3-1/2"	N/A	N/A	1-3/4"
BF962-C	SQUARE BUN FOOT	4"	4-5/8"	N/A	N/A	3"

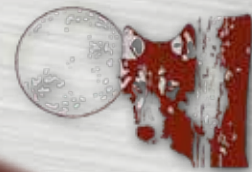

BRANSON FAMILY

16"

18"



Hood Corbel *Manchester*

Item No.	Tall	Deep	Wide	Description
BB-310-HC	18"	16"	3"	Hood Corbel
BB-410-HC	18"	16"	4-3/4"	Hood Corbel

Available in Alder, Cherry, Maple, Poplar, Red Oak & Rubberwood
 Rubberwood not available in 4-3/4"
 Other Species available upon request

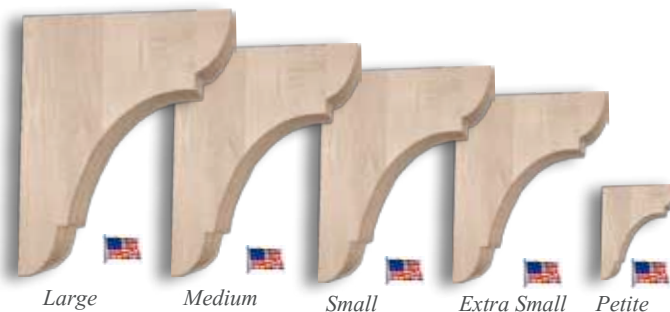

Large Medium Small Extra Small Petite



Overhang Bracket *Manchester*

Item No.	Tall	Deep	Wide	Description
BB-010-OH	10"	10"	1-3/4"	Overhang
BB-310-OH	10"	10"	3"	Overhang
BB-410-OH	10"	10"	4-3/4"	Overhang

Available in Alder, Cherry, Maple, Poplar, Red Oak & Rubberwood
 Rubberwood not available in 4-3/4"
 Other Species available upon request

Bar Brackets *Manchester*

	Item No.	Tall	Deep	Wide	Description
1-3/4" W	BB-010-L	12"	8"	1-3/4"	Large
	BB-010-M	9"	6-1/2"	1-3/4"	Medium
	BB-010-S	7-1/2"	5"	1-3/4"	Small
	BB-010-XS	6"	4"	1-3/4"	Extra Small
	BB-010-P	3"	3"	1-3/4"	Petite
3" W	BB-310-L	12"	8"	3"	Large
	BB-310-M	9"	6-1/2"	3"	Medium
	BB-310-S	7-1/2"	5"	3"	Small
	BB-310-XS	6"	4"	3"	Extra Small
	BB-310-P	3"	3"	3"	Petite
4-3/4" W	BB-410-L	12"	8"	4-3/4"	Large
	BB-410-M	9"	6-1/2"	4-3/4"	Medium
	BB-410-S	7-1/2"	5"	4-3/4"	Small
	BB-410-XS	6"	4"	4-3/4"	Extra Small

Available in Alder, Cherry, Maple, Poplar, Red Oak & Rubberwood
 Rubberwood not available in 4-3/4"
 Other Species available upon request



Traditional
CBL-PT4

Item No.	Tall	Deep	Wide
CBL-PT4	13"	7-3/4"	3-3/8"

Available in Alder, Cherry, Maple, Red Oak & Rubberwood



Athena
CBL-001-M

Item No.	Tall	Deep	Wide
CBL-001-S	6-3/4"	3-3/4"	3-1/2"
CBL-001-M	10"	5"	5"
CBL-001-L	14"	7"	5-1/4"

Available in Alder, Cherry, Maple, Poplar & Red Oak



Traditional
CBL-PT5

Item No.	Tall	Deep	Wide
CBL-PT5	4-1/4"	1-3/4"	2-7/8"

Available in Alder, Cherry, Maple, Red Oak & Rubberwood

Family Suites

"Leading the Pack"

BRANSON FAMILY

Fluted Square

Family Suites

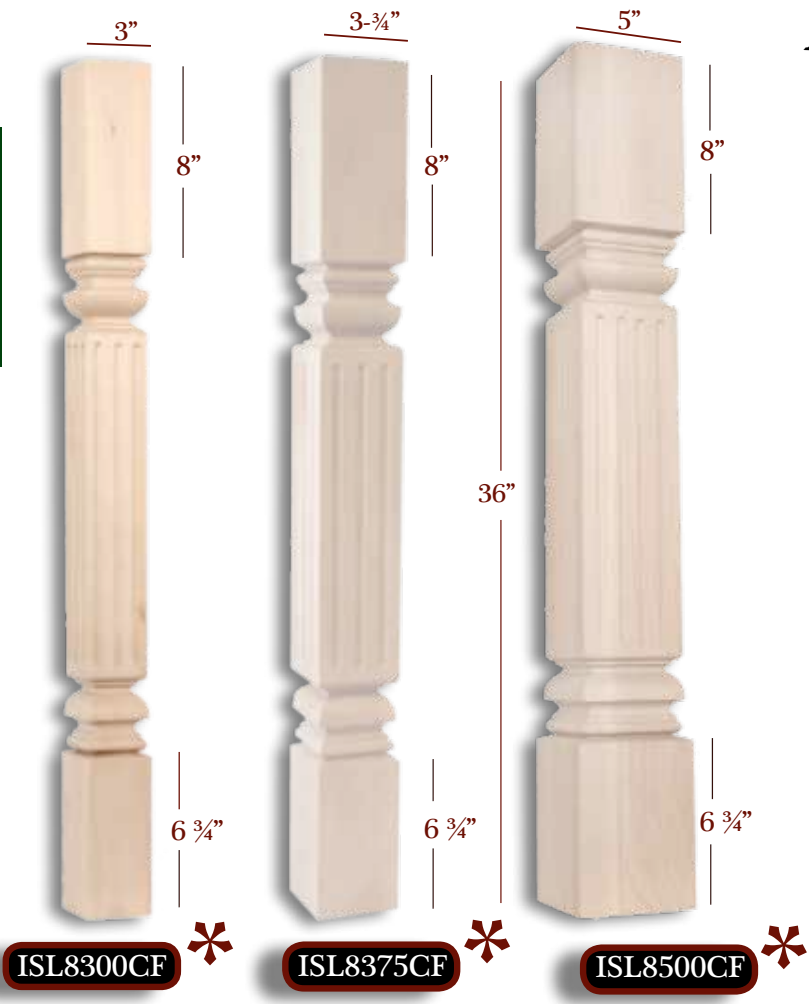

* Branson Series available in 36" & 42" tall & 3", 3-1/2", 3-3/4" & 5" sq.

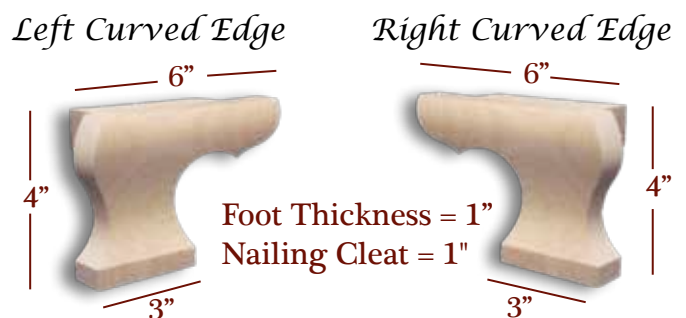

PFC-LC-4

PFC-RC-4

Corner Square Face

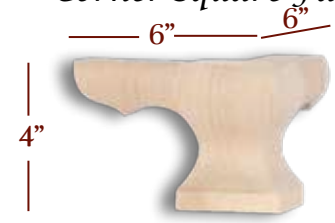

PFC-CS-4

Left Straight Edge Right Straight Edge



PFC-LS-4

PFC-RS-4

See table opposite page

Item No.	Description	Tall	Width	Top Shank Length	Bottom Shank Length
ISL8300CF	3" sq. x 36" FLUTED SQUARE	36"	3"	8"	6-3/4"
ISL8350CF	3-1/2" sq. x 36" FLUTED SQUARE	36"	3-1/2"	8"	6-3/4"
ISL8375CF	3-3/4" sq. x 36" FLUTED SQUARE	36"	3-3/4"	8"	6-3/4"
ISL8500CF	5" sq. x 36" FLUTED SQUARE	36"	5"	8"	6-3/4"
BAR8300CF	3" sq. x 42" FLUTED SQUARE	42"	3"	8"	6-3/4"
BAR8350CF	3-1/2" sq. x 42" FLUTED SQUARE	42"	3-1/2"	8"	6-3/4"
BAR8375CF	3-3/4" sq. x 42" FLUTED SQUARE	42"	3-3/4"	8"	6-3/4"
BAR8500CF	5" sq. x 42" FLUTED SQUARE	42"	5"	8"	6-3/4"

Available in Alder, Cherry, Maple, Red Oak & Rubberwood
Other Species upon request

American Made

Phone: 877-504-WOLF
(9 6 5 3)
sales@TimberWolfForest.com

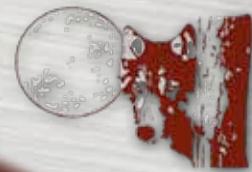

BRANSON FAMILY

Fluted Square



ISL8375CF
Shown in Picture

Family Suites

Pedestal feet available in 4" & 4-1/2". See table on this page. See opposite page for photos.

Item No.	Desc.	Tall	Width	Deep	Toe	Foot Thickness	Nailing Cleat Thickness
PFC-MM	Middle Moulding	1-7/8"	10"	3/4"	N/A	N/A	N/A
PFC-CS-4	Corner Square Face	4"	6"	6"	3"	N/A	N/A
PFC-CS-4.5	Corner Square Face	4-1/2"	6"	6"	3"	N/A	N/A
PFC-LC-4	Left Curved Edge	4"	6"	2"	3"	1"	1"
PFC-LC-4.5	Left Curved Edge	4-1/2"	6"	2"	3"	1"	1"
PFC-RC-4	Right Curved Edge	4"	6"	2"	3"	1"	1"
PFC-RC-4.5	Right Curved Edge	4-1/2"	6"	2"	3"	1"	1"
PFC-CR-4	Corner Round Face	4"	6"	6"	2-5/8"	N/A	N/A
PFC-CR-4.5	Corner Round Face	4-1/2"	6"	6"	2-5/8"	N/A	N/A
PFC-LS-4	Left Straight Edge	4"	6"	2"	3"	1"	1"
PFC-LS-4.5	Left Straight Edge	4-1/2"	6"	2"	3"	1"	1"
PFC-RS-4	Right Straight Edge	4"	6"	2"	3"	1"	1"
PFC-RS-4.5	Right Straight Edge	4-1/2"	6"	2"	3"	1"	1"

Available in Alder,
Cherry, Maple,
Poplar
& Red Oak
Other Species upon
request



Traditional
CBL-WC12F
Fluted



Traditional
CBL-WC12-5.75



Traditional
CBL-WC12-4.5



Traditional
CBL-WC12

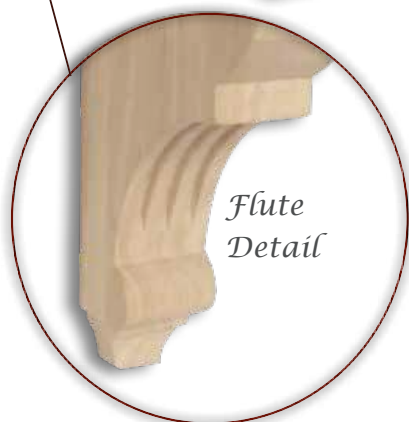

Flute
Detail

Item No.	Description	Tall	Deep	Wide
CBL-WC12	Plain	12"	6-1/2"	3"
CBL-WC12-4.5	Plain	12"	6-1/2"	4-1/2"
CBL-WC12-5.75	Plain	12"	6-1/2"	5-3/4"
CBL-WC12F	Fluted	12"	6-1/2"	3"

Available in Alder, Cherry, Maple,
Red Oak & Rubberwood

"Leading the Pack"

CHARLESTON FAMILY

Plain Square

Family Suites

ISL14275CP **ISL14350CP** **ISL14475CP**

*Available in Alder, Cherry, Maple, Poplar, Red Oak & Rubberwood
Other Species upon request*

BAR14275CP **BAR14350CP** **BAR14475CP**

Charleston Series Available in 29" Tall - see page 159

Item No.	Tall	Width at Beads	Shank length	Toe	Width of Top
ISL14275CP	36"	2-3/4"	8"	1-7/8"	2-3/8"
ISL14350CP	36"	3-1/2"	8"	2-1/2"	3"
ISL14475CP	36"	4-3/4"	8"	3-7/8"	4-3/8"
BAR14275CP	42"	2-3/4"	13-7/8"	1-7/8"	2-3/8"
BAR14350CP	42"	3-1/2"	13-7/8"	2-1/2"	3"
BAR14475CP	42"	4-3/4"	13-7/8"	3-7/8"	4-3/8"



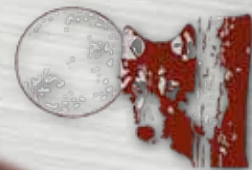

CHARLESTON FAMILY

Plain Square



Lexington

Hood Corbel

Item No.	Tall	Deep	Wide	Description
BB-304-HC	18"	16"	3"	Hood Corbel
BB-404-HC	18"	16"	4-3/4"	Hood Corbel

Available in Alder, Cherry, Maple, Poplar, Red Oak & Rubberwood
 Rubberwood not available in 4-3/4"
 Other Species available upon request



Lexington

Overhang Bracket

Item No.	Tall	Deep	Wide	Description
BB-004-OH	10"	10"	1-3/4"	Overhang
BB-304-OH	10"	10"	3"	Overhang
BB-404-OH	10"	10"	4-3/4"	Overhang

Available in Alder, Cherry, Maple, Poplar, Red Oak & Rubberwood
 Rubberwood not available in 4-3/4"
 Other Species available upon request

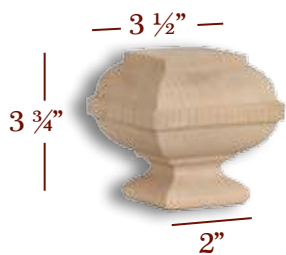

BF992-C

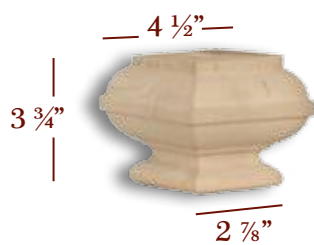

BF993-C



BFS14S-C



BFS14L-C

Item No.	Description	Tall	Width	Toe
BF992-C	SQUARE BUN FOOT	3-3/4"	3-1/2"	2"
BF993-C	SQUARE BUN FOOT	3-3/4"	4-1/2"	2-7/8"
BFS14S-C	SQUARE BUN FOOT	4"	3-1/2"	2-1/2"
BFS14L-C	SQUARE BUN FOOT	4"	4-3/4"	3-3/4"

Lexington Bar Brackets



	Item No.	Tall	Deep	Wide	Description
1-3/4" W	BB-004-L	12-3/4"	6-9/16"	1-3/4"	Large
	BB-004-M	9-1/2"	4-7/8"	1-3/4"	Medium
	BB-004-S	7-1/2"	4-1/4"	1-3/4"	Small
	BB-004-XS	6-1/8"	3-1/2"	1-3/4"	Extra Small
3" W	BB-304-L	12-3/4"	6-9/16"	3"	Large
	BB-304-M	9-1/2"	4-7/8"	3"	Medium
	BB-304-S	7-1/2"	4-1/4"	3"	Small
	BB-304-XS	6-1/8"	3-1/2"	3"	Extra Small
4-3/4" W	BB-404-L	12-3/4"	6-9/16"	4-3/4"	Large
	BB-404-M	9-1/2"	4-7/8"	4-3/4"	Medium
	BB-404-S	7-1/2"	4-1/4"	4-3/4"	Small
	BB-404-XS	6-1/8"	3-1/2"	4-3/4"	Extra Small

Available in Alder, Cherry, Maple, Poplar, Red Oak & Rubberwood
 Rubberwood not available in 4-3/4"
 Other Species available upon request

Family Suites

"Leading the Pack"

COSMO FAMILY

Family Suites

Tapered Square

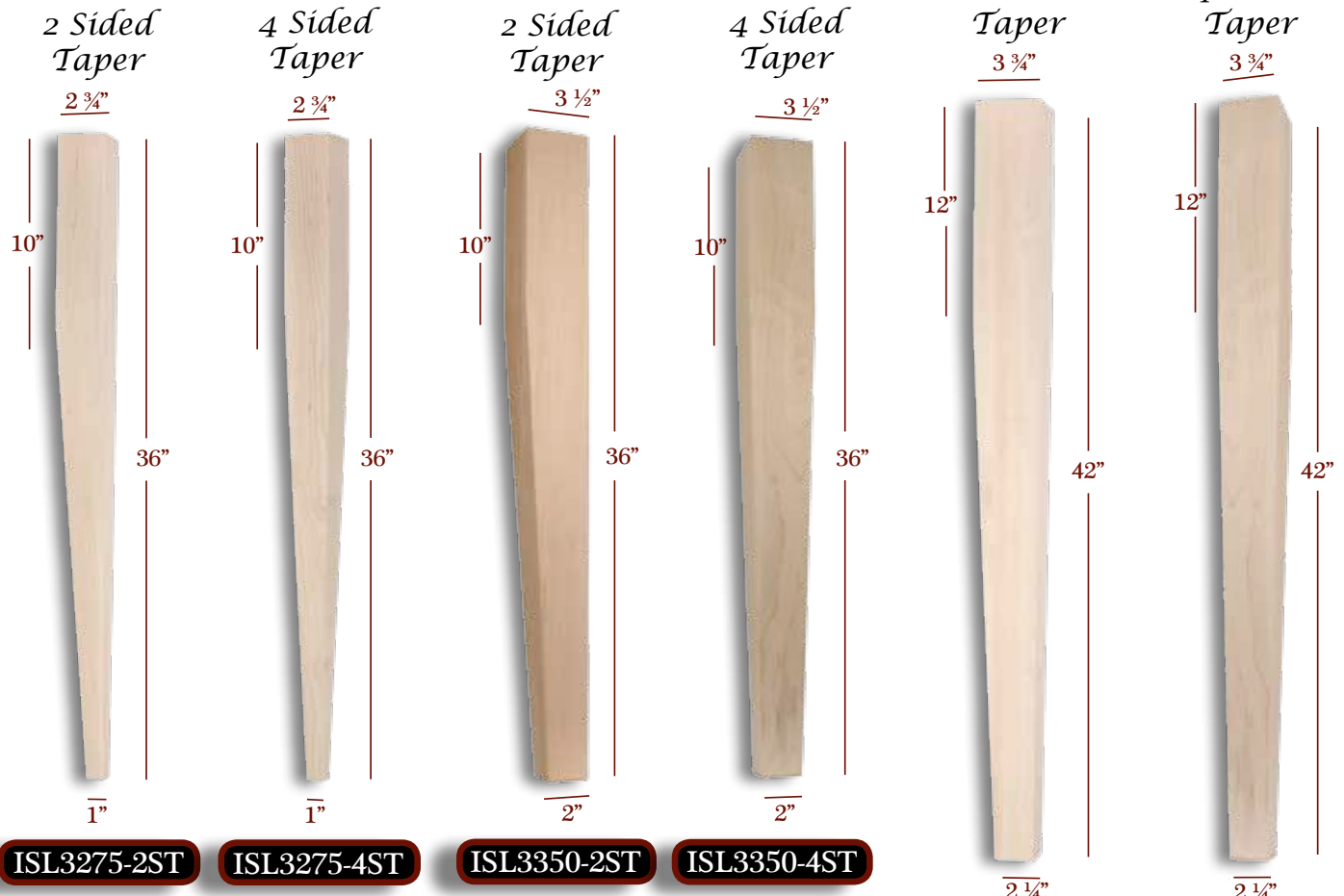

ISL3275-2ST **ISL3275-4ST** **ISL3350-2ST** **ISL3350-4ST**

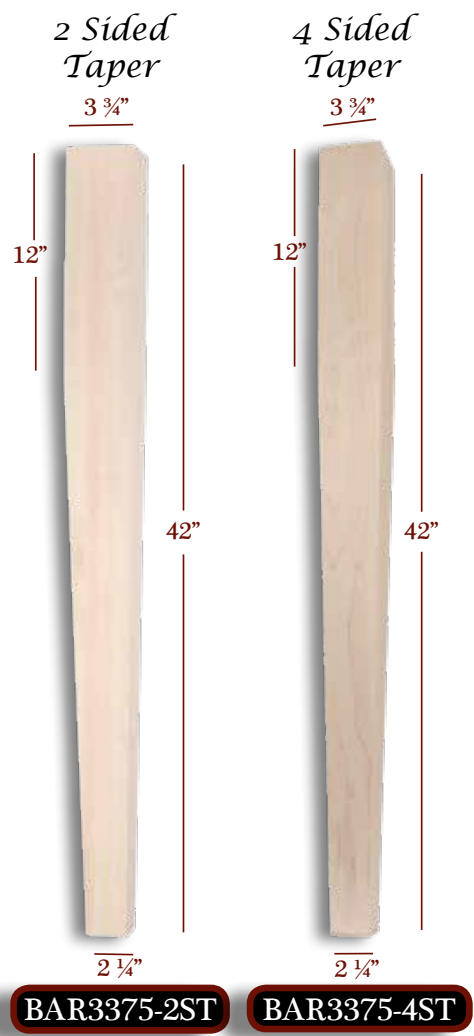

BAR3375-2ST **BAR3375-4ST**

* *Cosmo Series is also available in 18\", 21\" & 29\" See Page 160-162*

Item No.	Tall	Width	Top Shank Length	Toe
BAR3350-2ST	42"	3-1/2"	12"	2"
BAR3350-4ST	42"	3-1/2"	12"	2"
BAR3375-2ST	42"	3-3/4"	12"	2-1/4"
BAR3375-4ST	42"	3-3/4"	12"	2-1/4"
ISL3275-2ST	36"	2-3/4"	10"	1"
ISL3275-4ST	36"	2-3/4"	10"	1"
ISL3350-2ST	36"	3-1/2"	10"	2"
ISL3350-4ST	36"	3-1/2"	10"	2"
ISL3375-2ST	36"	3-3/4"	10"	2-1/4"
ISL3375-4ST	36"	3-3/4"	10"	2-1/4"

*Available in Alder, Cherry, Maple, Poplar, Red Oak & Rubberwood
Other Species upon request*



BF225-60 **BF225-40** **BF802**

Item No.	Tall	Overall Width	Toe	Species
BF225-40	4"	2-1/4"	1-1/8"	Cherry, Maple, Red Oak, Rubberwood
BF225-60	6"	2-1/4"	1-1/8"	
BF802	3"	3"	2-7/16"	Alder, Cherry, Maple, Pine, Red Oak, Rubberwood
BF820	4-1/2"	4-1/2"	3-5/8"	
BF821	4-1/2"	4-1/2"x3-1/2"	3-1/2"x2-1/2"	

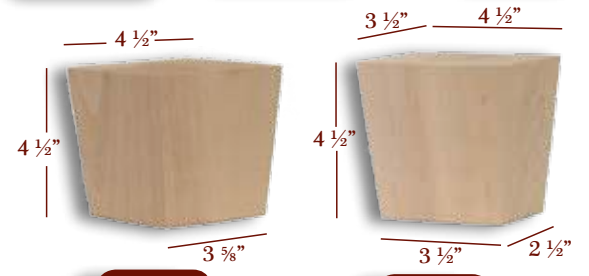

BF820 **BF821**

*Available in Species specified in Table above.
Other Species upon request*

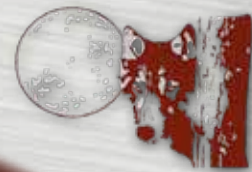

COSMO FAMILY

Tapered Square



Cortez
Hood
Corbel

Item No.	Tall	Deep	Wide	Description
BB-307-HC	18"	16"	3"	Hood Corbel
BB-407-HC	18"	16"	4-3/4"	Hood Corbel

Available in Alder, Cherry, Maple, Poplar, Red Oak & Rubberwood
Rubberwood not available in 4-3/4"
Other Species available upon request



Cortez
Overhang
Bracket

Item No.	Tall	Deep	Wide	Description
BB-007-OH	10"	10"	1-3/4"	Overhang
BB-307-OH	10"	10"	3"	Overhang
BB-407-OH	10"	10"	4-3/4"	Overhang

Available in Alder, Cherry, Maple, Poplar, Red Oak & Rubberwood
Rubberwood not available in 4-3/4"
Other Species available upon request



Large



Medium



Small



Extra Small

Cortez
Bar Brackets

	Item No.	Tall	Deep	Wide	Description
1-3/4" W	BB-007-L	12"	8"	1-3/4"	Large
	BB-007-M	9"	6-1/2"	1-3/4"	Medium
	BB-007-S	7-1/2"	5"	1-3/4"	Small
	BB-007-XS	6"	4"	1-3/4"	Extra Small

	Item No.	Tall	Deep	Wide	Description
3" W	BB-307-L	12"	8"	3"	Large
	BB-307-M	9"	6-1/2"	3"	Medium
	BB-307-S	7-1/2"	5"	3"	Small
	BB-307-XS	6"	4"	3"	Extra Small

	Item No.	Tall	Deep	Wide	Description
4-3/4" W	BB-407-L	12"	8"	4-3/4"	Large
	BB-407-M	9"	6-1/2"	4-3/4"	Medium
	BB-407-S	7-1/2"	5"	4-3/4"	Small
	BB-407-XS	6"	4"	4-3/4"	Extra Small

Available in Alder, Cherry, Maple, Poplar, Red Oak & Rubberwood
Rubberwood not available in 4-3/4"
Other Species available upon request



Cape Cod
CBL-006-M



Hudson
CBL-007-M



Eastwood
CBL-008-M

Available in Alder, Cherry, Maple, Poplar & Red Oak
Other Species upon request

Item No.	Tall	Deep	Wide
CBL-006-M	10"	6-3/8"	3"
CBL-007-M	10"	6"	3"
CBL-008-M	10"	6"	3"



"Leading the Pack"

DELLINGER FAMILY

Plain Round

Family Suites

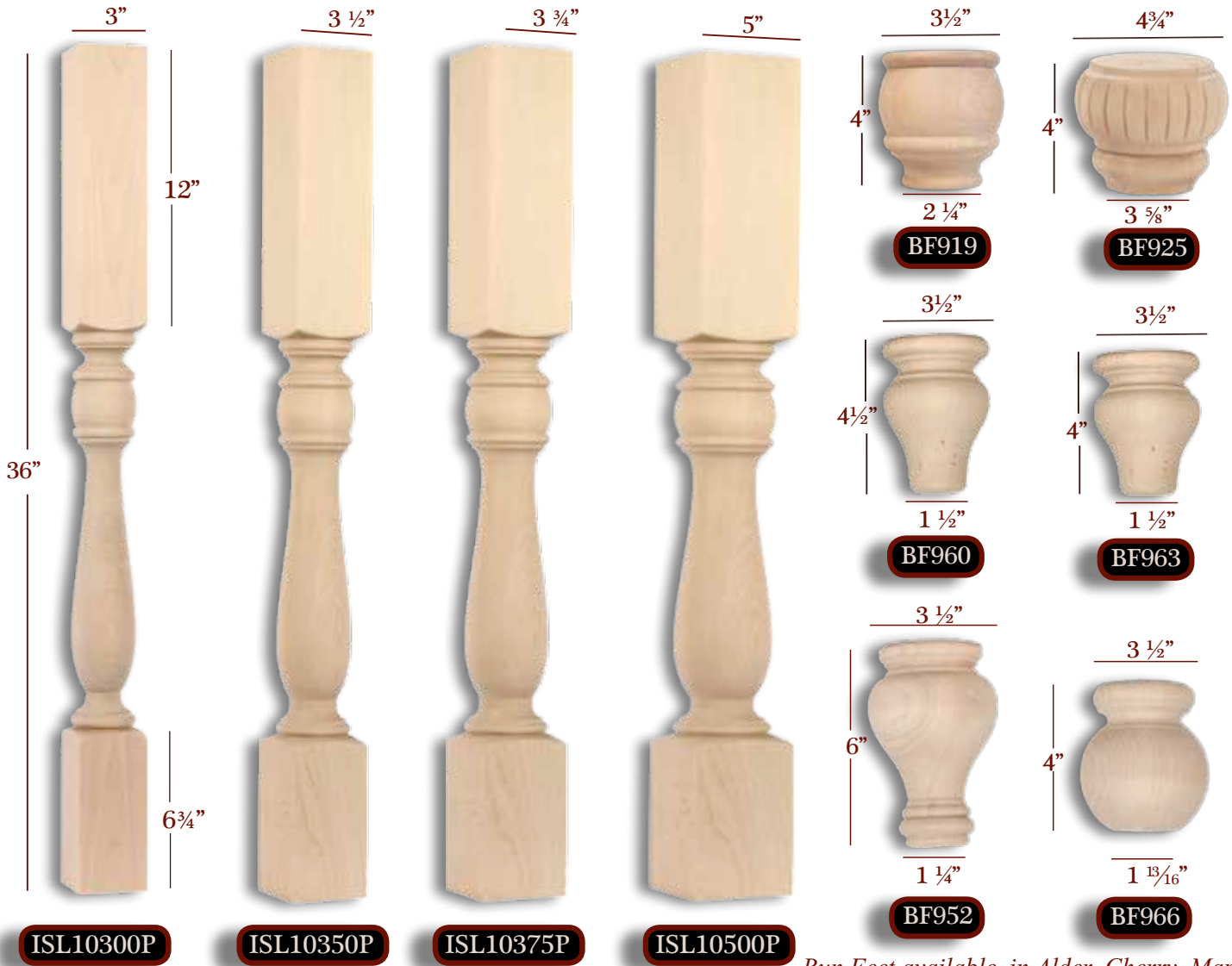

Posts available in Alder, Cherry, Maple, Poplar, Red Oak & Rubberwood
 Other Species upon request

Bun Feet available in Alder, Cherry, Maple, Poplar, Red Oak, Rubberwood & White Pine
 Other Species upon request



Item No.	Desc.	Tall	Overall Width	Top Shank Length	Toe
BF919	Plain	4"	3-1/2"	N/A	2-1/4"
BF925	Reeded	4"	4-3/4"	N/A	2-5/8"
BF952	Plain	6"	3-1/2"	N/A	1-1/4"
BF960	Plain	4-1/2"	3-1/2"	N/A	1-1/2"
BF963	Plain	4"	3-1/2"	N/A	1-1/2"
BF966	Plain	4"	3-1/2"	N/A	1-13/16"
ISL10300p	Plain	36"	3"	12"	N/A
ISL10350P	Plain	36"	3-1/2"	12"	N/A
ISL10375P	Plain	36"	3-3/4"	12"	N/A
ISL10500P	Plain	36"	5"	12"	N/A

*Dellinger Series also available 29" tall. See pages 163



American Made



Phone: 877-504-WOLF
 (9 6 5 3)
 sales@TimberWolfForest.com

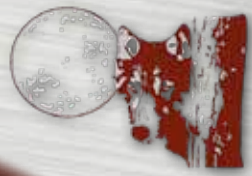

DELLINGER FAMILY

Family Suites

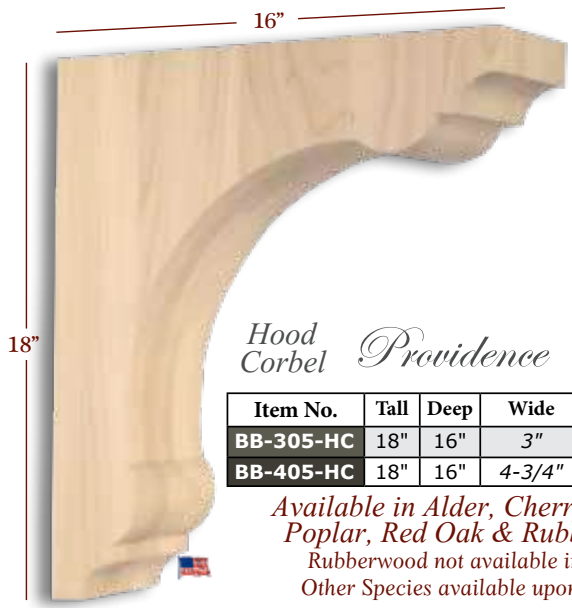

Hood Corbel Providence

Item No.	Tall	Deep	Wide	Description
BB-305-HC	18"	16"	3"	Hood Corbel
BB-405-HC	18"	16"	4-3/4"	Hood Corbel

Available in Alder, Cherry, Maple, Poplar, Red Oak & Rubberwood
 Rubberwood not available in 4-3/4"
 Other Species available upon request



Large

Medium

Small

Extra Small

Bar Brackets Providence

	Item No.	Tall	Deep	Wide	Description
1-3/4" W	BB-005-L	12-1/2"	6-1/2"	1-3/4"	Large
	BB-005-M	9-9/16"	5"	1-3/4"	Medium
	BB-005-S	7-3/4"	4"	1-3/4"	Small
	BB-005-XS	6-5/16"	3-1/4"	1-3/4"	Extra Small
3" W	BB-305-L	12-1/2"	6-1/2"	3"	Large
	BB-305-M	9-9/16"	5"	3"	Medium
	BB-305-S	7-3/4"	4"	3"	Small
	BB-305-XS	6-5/16"	3-1/4"	3"	Extra Small
4-3/4" W	BB-405-L	12-1/2"	6-1/2"	4-3/4"	Large
	BB-405-M	9-9/16"	5"	4-3/4"	Medium
	BB-405-S	7-3/4"	4"	4-3/4"	Small
	BB-405-XS	6-5/16"	3-1/4"	4-3/4"	Extra Small

Available in Alder, Cherry, Maple, Poplar, Red Oak & Rubberwood
 Rubberwood not available in 4-3/4"
 Other Species available upon request

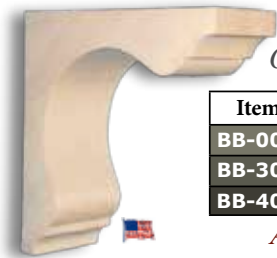

Overhang Bracket Providence

Item No.	Tall	Deep	Wide	Description
BB-005-OH	10"	10"	1-3/4"	Overhang
BB-305-OH	10"	10"	3"	Overhang
BB-405-OH	10"	10"	4-3/4"	Overhang

Available in Alder, Cherry, Maple, Poplar, Red Oak & Rubberwood
 Rubberwood not available in 4-3/4"
 Other Species available upon request



CBL-PT3



CBL-PT2



CBL-PT1



CBL-PT4



CBL-PT5

Traditional

Item No.	Tall	Deep	Wide	Description	Species
CBL-PT1	10"	5-1/4"	4-1/2"	Corbel - Small Trad. Corbel	These Items are available in Alder, Cherry, Maple, Red Oak, & Rubberwood
CBL-PT2	14"	7"	5"	Corbel - Medium Trad. Corbel	
CBL-PT3	22"	7-5/8"	6-3/4"	Corbel - Large Trad. Corbel	
CBL-PT4	13"	7-3/4"	3-3/8"	Corbel - Traditional Bar Bracket	
CBL-PT5	4-1/4"	1-3/4"	2-7/8"	Corbel - Mini Traditional	

"Leading the Pack"

DILLON FAMILY

Family Suites

Plain Square

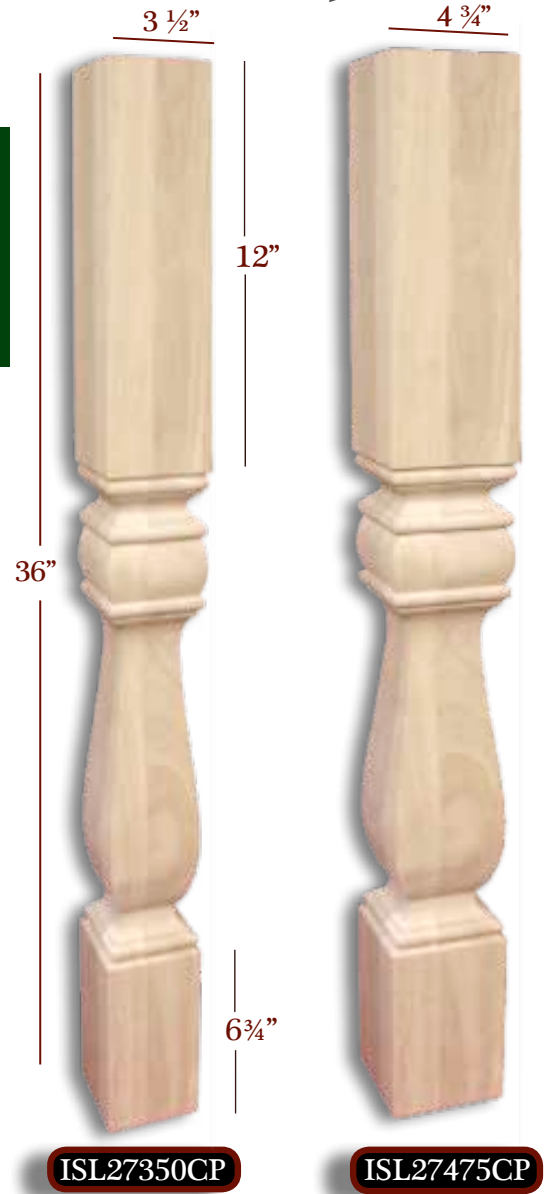

ISL27350CP

ISL27475CP

Posts available in Alder, Cherry, Maple, Poplar, Red Oak & Rubberwood
Other Species upon request



BF904-C



BF920-C



BF926-C



BF914-C



BF927-C

Bun Feet available in Alder, Cherry, Maple, Poplar, Red Oak, Rubberwood & White Pine
Other Species upon request

Item No.	Tall	Width	Top Shank Length	Bottom Shank Length
ISL27350CP	36"	3-1/2"	12"	6-3/4"
ISL27475CP	36"	4-3/4"	12"	6-3/4"

Item No.	Tall	Overall Width	Toe
BF904-C	4-1/2"	4-3/4"	2-3/4"
BF914-C	9-1/8"	3-1/2"	1"
BF920-C	4"	3-1/2"	2-1/4"
BF926-C	4"	3-1/2"	1-3/8"
BF927-C	4"	4-1/2"	2-7/16"

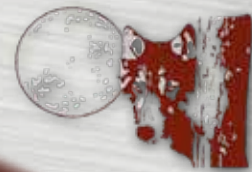

DILLON FAMILY

16"



Hood Corbel *Manchester*

Item No.	Tall	Deep	Wide	Description
BB-310-HC	18"	16"	3"	Hood Corbel
BB-410-HC	18"	16"	4-3/4"	Hood Corbel

Available in Alder, Cherry, Maple, Poplar, Red Oak & Rubberwood
 Rubberwood not available in 4-3/4"
 Other Species available upon request

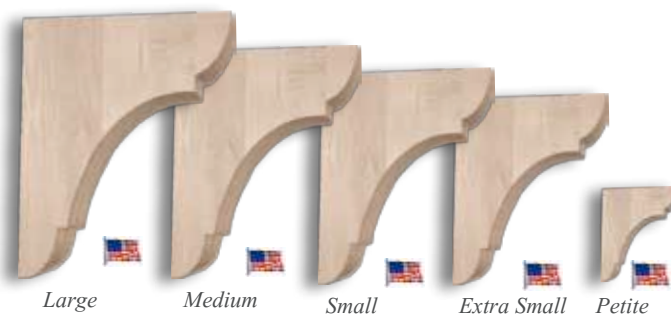

Large Medium Small Extra Small Petite

Bar Brackets *Manchester*

	Item No.	Tall	Deep	Wide	Description
1-3/4" W	BB-010-L	12"	8"	1-3/4"	Large
	BB-010-M	9"	6-1/2"	1-3/4"	Medium
	BB-010-S	7-1/2"	5"	1-3/4"	Small
	BB-010-XS	6"	4"	1-3/4"	Extra Small
	BB-010-P	3"	3"	1-3/4"	Petite
3" W	BB-310-L	12"	8"	3"	Large
	BB-310-M	9"	6-1/2"	3"	Medium
	BB-310-S	7-1/2"	5"	3"	Small
	BB-310-XS	6"	4"	3"	Extra Small
	BB-310-P	3"	3"	3"	Petite
4-3/4" W	BB-410-L	12"	8"	4-3/4"	Large
	BB-410-M	9"	6-1/2"	4-3/4"	Medium
	BB-410-S	7-1/2"	5"	4-3/4"	Small
	BB-410-XS	6"	4"	4-3/4"	Extra Small

Available in Alder, Cherry, Maple, Poplar, Red Oak & Rubberwood
 Rubberwood not available in 4-3/4"
 Other Species available upon request



Overhang Bracket *Manchester*

Item No.	Tall	Deep	Wide	Description
BB-010-OH	10"	10"	1-3/4"	Overhang
BB-310-OH	10"	10"	3"	Overhang
BB-410-OH	10"	10"	4-3/4"	Overhang

Available in Alder, Cherry, Maple, Poplar, Red Oak & Rubberwood
 Rubberwood not available in 4-3/4"
 Other Species available upon request



Traditional
CBL-WC12-5.75



Traditional
CBL-WC12-4.5



Traditional
CBL-WC12

Item No.	Description	Tall	Deep	Wide
CBL-WC12	Plain	12"	6-1/2"	3"
CBL-WC12-4.5	Plain	12"	6-1/2"	4-1/2"
CBL-WC12-5.75	Plain	12"	6-1/2"	5-3/4"

Available in Alder, Cherry, Maple, Red Oak & Rubberwood

Family Suites

"Leading the Pack"

ELLIS FAMILY

Plain Square

Family Suites

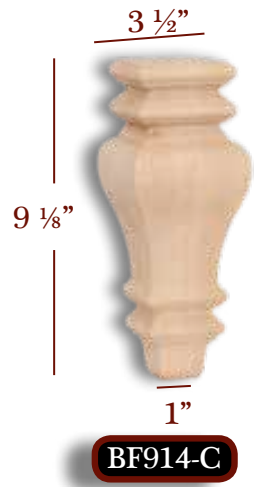
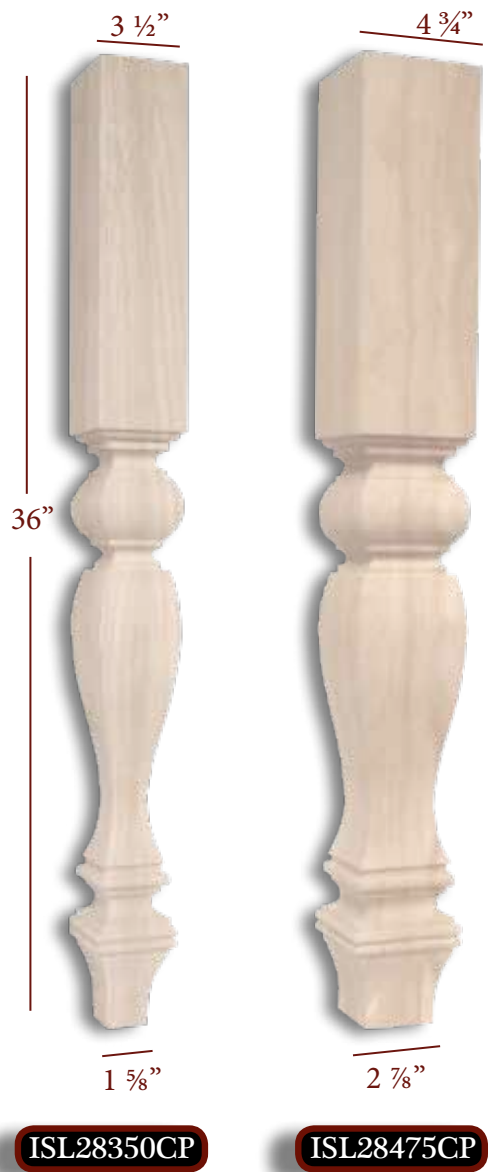

Item No.	Tall	Overall Width	Top Shank Length	Toe
ISL28350CP	36"	3-1/2"	13-3/4"	1-5/8"
ISL28475CP	36"	4-3/4"	13-3/4"	2-7/8"
BF904-C	4-1/2"	4-3/4"	N/A	2-3/4"
BF914-C	9-1/8"	3-1/2"	N/A	1"
BF926-C	4"	3-1/2"	N/A	1-3/8"
BF927-C	4"	4-1/2"	N/A	2-7/16"
BF958-C	4-1/2"	3-1/2"	N/A	1-3/4"
BF959-C	4-1/2"	4-5/8"	N/A	3"
BF961-C	4"	3-1/2"	N/A	1-3/4"
BF962-C	4"	4-5/8"	N/A	3"

Available in Alder, Cherry, Maple, Poplar, Red Oak & Rubberwood
Other Species upon request

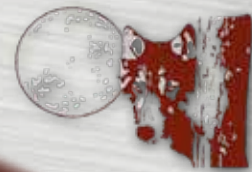

ELLIS FAMILY

Family Suites

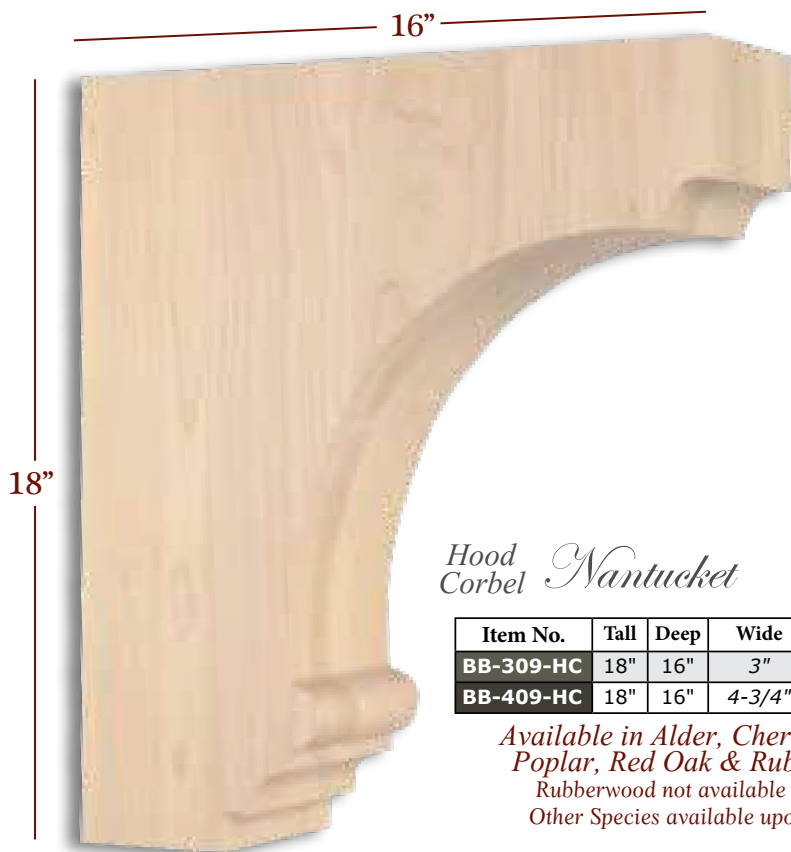

Hood Corbel *Nantucket*

Item No.	Tall	Deep	Wide	Description
BB-309-HC	18"	16"	3"	Hood Corbel
BB-409-HC	18"	16"	4-3/4"	Hood Corbel

Available in Alder, Cherry, Maple, Poplar, Red Oak & Rubberwood
 Rubberwood not available in 4-3/4"
 Other Species available upon request



Overhang Bracket *Nantucket*

Item No.	Tall	Deep	Wide	Description
BB-009-OH	10"	10"	1-3/4"	Overhang
BB-309-OH	10"	10"	3"	Overhang
BB-409-OH	10"	10"	4-3/4"	Overhang

Available in Alder, Cherry, Maple, Poplar, Red Oak & Rubberwood
 Rubberwood not available in 4-3/4"
 Other Species available upon request

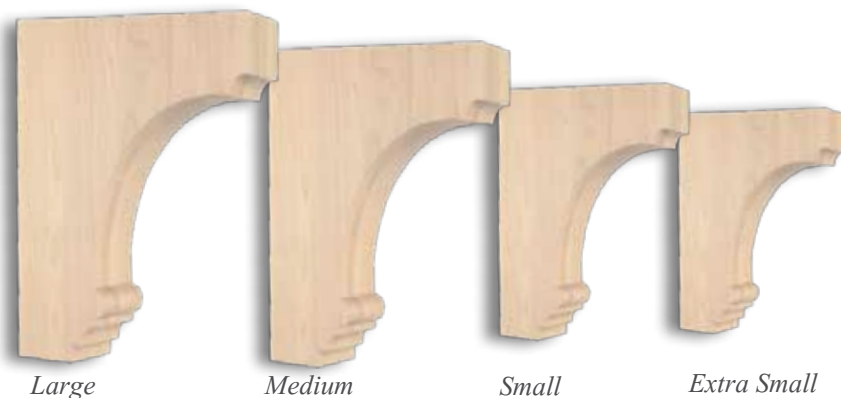

Bar Brackets *Nantucket*

	Item No.	Tall	Deep	Wide	Description
1-3/4" W	BB-009-L	12"	8"	1-3/4"	Large
	BB-009-M	9"	6-1/2"	1-3/4"	Medium
	BB-009-S	7-1/2"	5"	1-3/4"	Small
	BB-009-XS	6"	4"	1-3/4"	Extra Small
3" W	BB-309-L	12"	8"	3"	Large
	BB-309-M	9"	6-1/2"	3"	Medium
	BB-309-S	7-1/2"	5"	3"	Small
	BB-309-XS	6"	4"	3"	Extra Small
4-3/4" W	BB-409-L	12"	8"	4-3/4"	Large
	BB-409-M	9"	6-1/2"	4-3/4"	Medium
	BB-409-S	7-1/2"	5"	4-3/4"	Small
	BB-409-XS	6"	4"	4-3/4"	Extra Small

Available in Alder, Cherry, Maple, Poplar, Red Oak & Rubberwood
 Rubberwood not available in 4-3/4"
 Other Species available upon request

"Leading the Pack"

EMPIRE FAMILY

Family Suites

Plain Round

Reeded Round

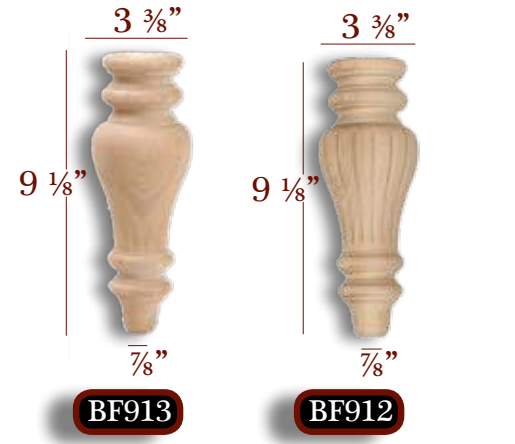
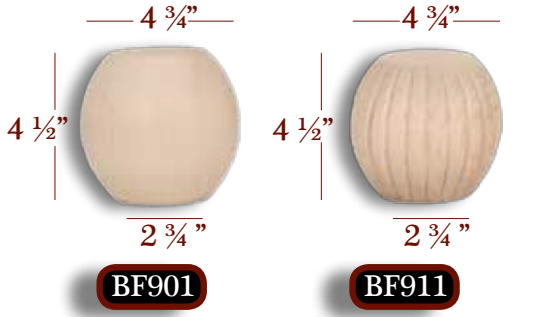
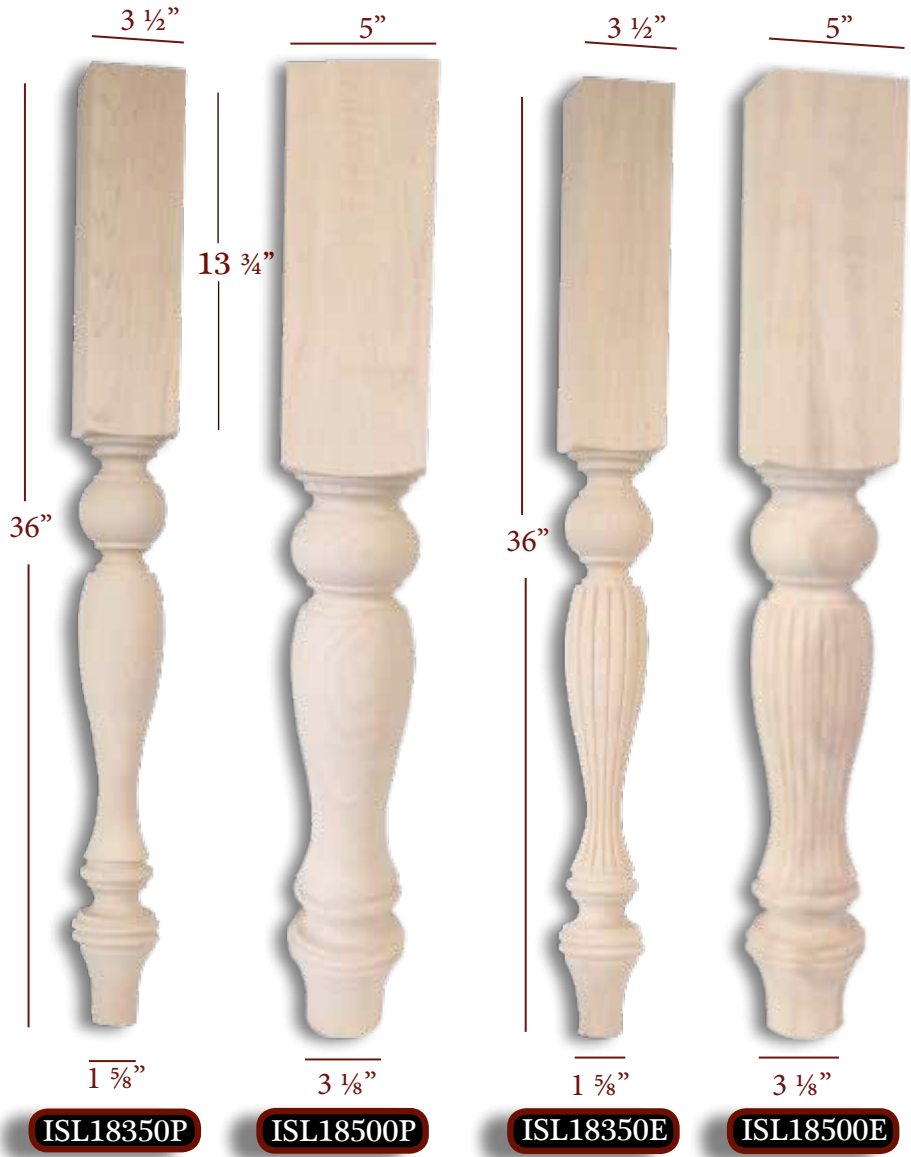

Item No.	Tall	Width	Top Shank Length	Toe	
ISL18350P	36"	3-1/2"	13-3/4"	1-5/8"	<i>Available in Alder, Cherry, Maple, Poplar, Red Oak & Rubberwood</i>
ISL18500P	36"	5"	13-3/4"	3-1/8"	
ISL18350E	36"	3-1/2"	13-3/4"	1-5/8"	
ISL18500E	36"	5"	13-3/4"	3-1/8"	
BF900	2-3/4"	4-3/4"	N/A	2-13/16"	<i>Available in Alder, Cherry, Maple, Pine, Poplar, Red Oak & Rubberwood</i>
BF901	4-1/2"	4-3/4"	N/A	2-3/4"	
BF903	5-1/2"	3-5/8"	N/A	1-1/16"	
BF910	2-3/4"	4-3/4"	N/A	2-13/16"	
BF911	4-1/2"	4-3/4"	N/A	2-3/4"	
BF912	9-1/8"	3-3/8"	N/A	7/8"	
BF913	9-1/8"	3-3/8"	N/A	7/8"	
BF925	4"	4-3/4"	N/A	2-5/8"	

Other Species upon request

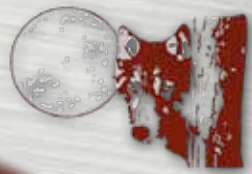

EMPIRE FAMILY

Family Suites



Athena
CBL-001-L



Athena
CBL-001-M



Athena
CBL-001-S



Traditional
CBL-PT5



Traditional
CBL-PT4

Item No.	Tall	Deep	Wide
CBL-001-S	6-3/4"	3-3/4"	3-1/2"
CBL-001-M	10"	5"	5"
CBL-001-L	14"	7"	5-1/4"

Available in Alder, Cherry, Maple, Poplar & Red Oak

Item No.	Tall	Deep	Wide
CBL-PT5	4-1/4"	1-3/4"	2-7/8"

Available in Alder, Cherry, Maple, Red Oak & Rubberwood

Item No.	Tall	Deep	Wide
CBL-PT4	13"	7-3/4"	3-3/8"

Available in Alder, Cherry, Maple, Red Oak & Rubberwood



CBL-VT149



CBL-VT153



CBL-VT159



CBL-VT158



CBL-VT174



CBL-VT170

Traditional

Item No.	Tall	Deep	Wide
CBL-VT149	42"	9"	8-1/2"
CBL-VT153	36"	8"	7-1/2"
CBL-VT159	26-1/2"	7-1/2"	7"
CBL-VT158	18-1/2"	7"	5-7/8"
CBL-VT174	14"	5-3/4"	5"
CBL-VT170	10-1/2"	5"	3-7/8"

Available in Alder, Aspen, Cherry, Maple & Oak

Also available in low profile
See page 106 for details

"Leading the Pack"

ESSENTIAL FAMILY

Family Suites

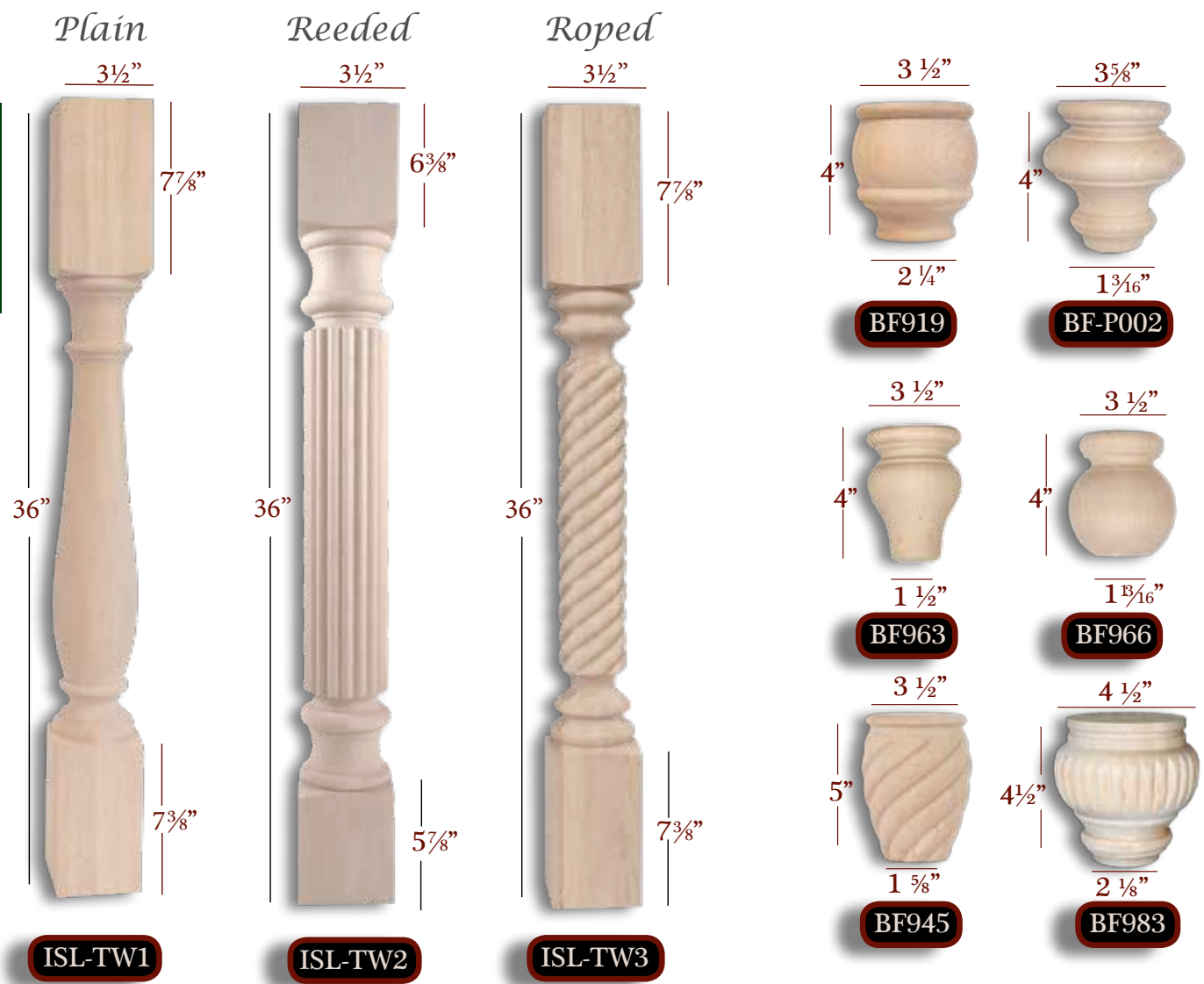

Available in Alder, Cherry, Maple, Poplar, Red Oak & Rubberwood
Other Species upon request

Item No.	Desc.	Tall	Overall Width	Top Shank Length	Bottom Shank Length	Toe
ISL-TW1	Plain	36"	3-1/2"	7-7/8"	7-3/8"	N/A
ISL-TW1-5	Plain	36"	5"	7-7/8"	7-3/8"	N/A
ISL-TW2	Reeded	36"	3-1/2"	6-3/8"	5-7/8"	N/A
ISL-TW3	Roped	36"	3-1/2"	7-7/8"	7-3/8"	N/A
BF919	Plain	4"	3-1/2"	N/A	N/A	2-1/4"
BF-P002	Plain	4"	3-5/8"	N/A	N/A	1-13/16"
BF963	Plain	4"	3-1/2"	N/A	N/A	1-1/2"
BF966	Plain	4"	3-1/2"	N/A	N/A	1-13/16"
BF945	Roped	5"	3-1/2"	N/A	N/A	1-5/8"
BF983	Reeded	4-1/2"	4-1/2"	N/A	N/A	2-1/8"

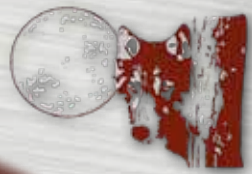

ESSENTIAL FAMILY

Family Suites



Scalloped

Hood Corbel

Item No.	Tall	Deep	Wide	Description
BB-302-HC	18"	16"	3"	Hood Corbel
BB-402-HC	18"	16"	4-3/4"	Hood Corbel

Available in Alder, Cherry, Maple, Poplar, Red Oak & Rubberwood
 Rubberwood not available in 4-3/4"
 Other Species available upon request



Scalloped

Overhang Bracket

Item No.	Tall	Deep	Wide	Description
BB-002-OH	10"	10"	1-3/4"	Overhang
BB-302-OH	10"	10"	3"	Overhang
BB-402-OH	10"	10"	4-3/4"	Overhang

Available in Alder, Cherry, Maple, Poplar, Red Oak & Rubberwood
 Rubberwood not available in 4-3/4"
 Other Species available upon request



Item No.	Tall	Deep	Wide
CBL-WC16	10-1/2"	7-1/2"	2"

Available in Alder, Cherry, Maple, Poplar & Rubberwood
 Other Species upon request

CBL-WC16



Scalloped

Bar Brackets

Large Medium Small Extra Small

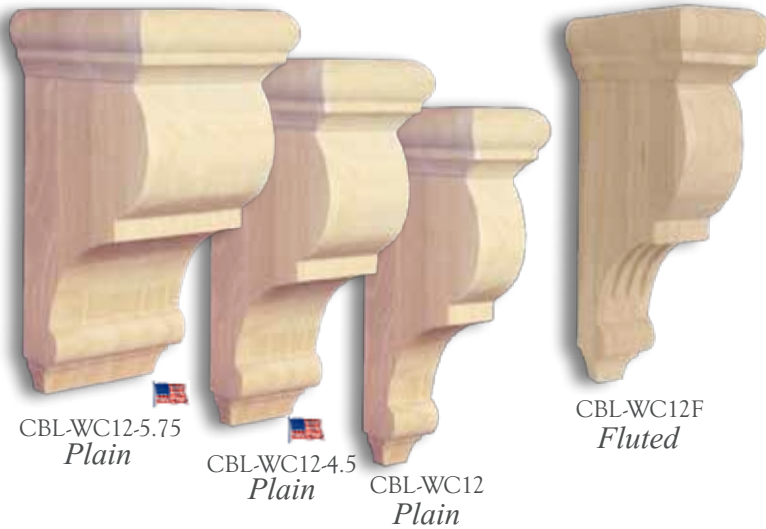

CBL-WC12-5.75 Plain

CBL-WC12-4.5 Plain

CBL-WC12 Plain

CBL-WC12F Fluted

Item No.	Description	Tall	Deep	Wide
CBL-WC12	Plain	12"	6-1/2"	3"
CBL-WC12-4.5	Plain	12"	6-1/2"	4-1/2"
CBL-WC12-5.75	Plain	12"	6-1/2"	5-3/4"
CBL-WC12F	Fluted	12"	6-1/2"	3"

Available in Alder, Cherry, Maple, Red Oak & Rubberwood

	Item No.	Tall	Deep	Wide	Description
1-3/4" W	BB-002-L	14-5/32"	8"	1-3/4"	Large
	BB-002-M	10-5/8"	5-1/2"	1-3/4"	Medium
	BB-002-S	9"	5"	1-3/4"	Small
	BB-002-XS	7-3/16"	4"	1-3/4"	Extra Small
3" W	BB-302-L	14-5/32"	8"	3"	Large
	BB-302-M	10-5/8"	5-1/2"	3"	Medium
	BB-302-S	9"	5"	3"	Small
	BB-302-XS	7-3/16"	4"	3"	Extra Small
4-3/4" W	BB-402-L	14-5/32"	8"	4-3/4"	Large
	BB-402-M	10-5/8"	5-1/2"	4-3/4"	Medium
	BB-402-S	9"	5"	4-3/4"	Small
	BB-402-XS	7-3/16"	4"	4-3/4"	Extra Small

Available in Alder, Cherry, Maple, Poplar, Red Oak & Rubberwood
 Rubberwood not available in 4-3/4"
 Other Species available upon request

"Leading the Pack"

FRANKLIN FAMILY

Family Suites

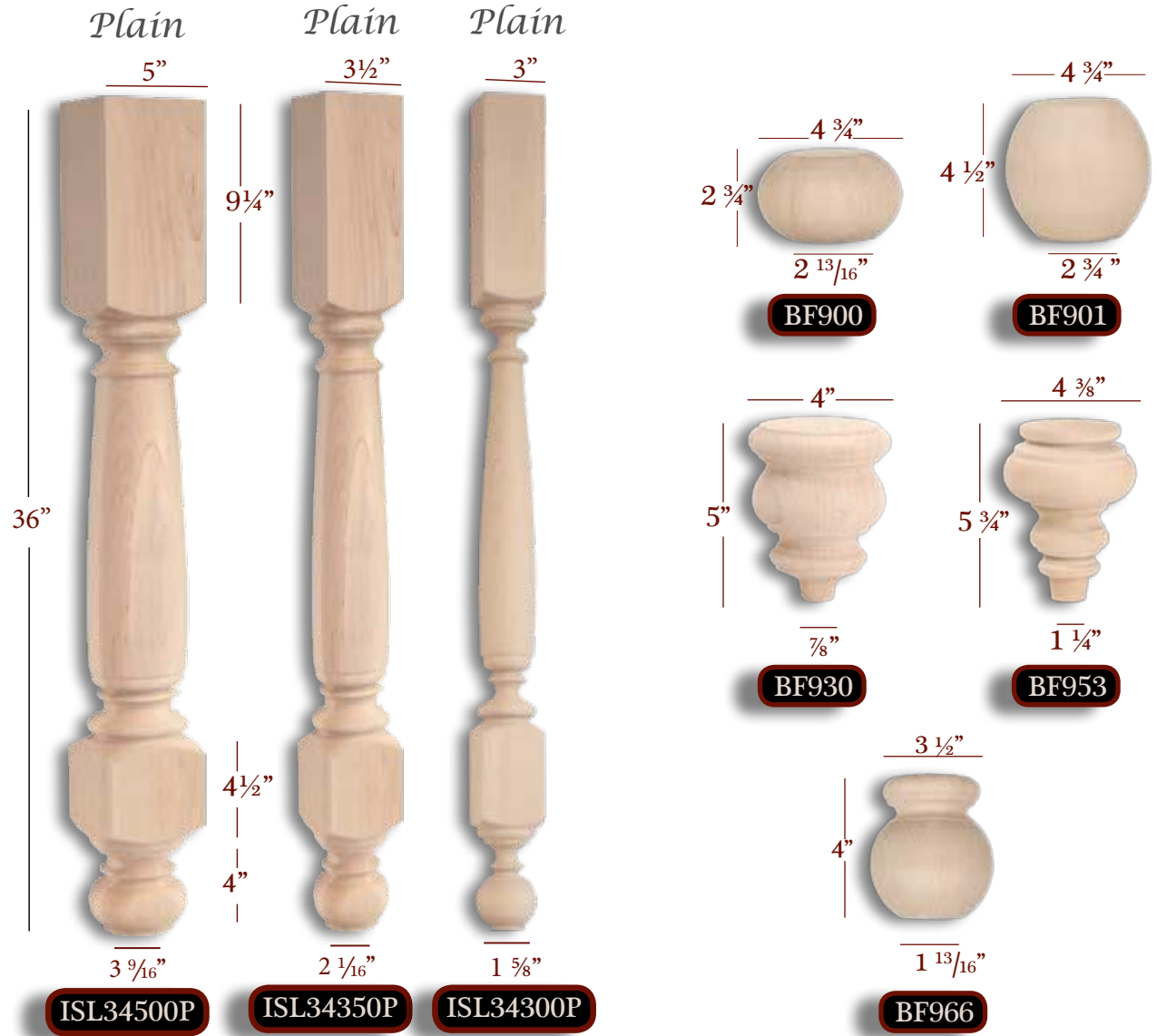

Franklin Legs available in Alder, Cherry, Maple, Poplar, Red Oak & Rubberwood
Other Species upon request

Bun Feet available in Alder, Cherry, Maple, Pine, Poplar, Red Oak & Rubberwood
Other Species upon request

Item No.	Desc.	Tall	Overall Width	Top Shank Length	Bottom Shank Length	Block	Toe
ISL34300P	Plain	36"	3"	9-1/4"	N/A	4-1/2"	1-5/8"
ISL34350P	Plain	36"	3-1/2"	9-1/4"	N/A	4-1/2"	2-1/16"
ISL34500P	Plain	36"	5"	9-1/4"	N/A	4-1/2"	3-9/16"
BF900	Plain	2-3/4"	4-3/4"	N/A	N/A	N/A	2-13/16"
BF901	Plain	4-1/2"	4-3/4"	N/A	N/A	N/A	2-3/4"
BF930	Plain	5"	4"	N/A	N/A	N/A	7/8"
BF953	Plain	5-3/4"	4-3/8"	N/A	N/A	N/A	1-1/4"
BF966	Plain	4"	3-1/2"	N/A	N/A	N/A	1-13/16"

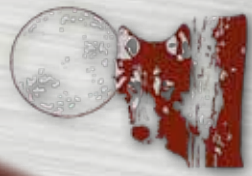

FRANKLIN FAMILY

Family Suites



Rockefeller
Massive
Hood Corbel

Item No.	Tall	Deep	Wide	Description
BB-611-MHC	26"	19"	6"	Massive Hood Corbel

Available in Alder, Cherry, Maple, Poplar, Red Oak & Rubberwood
Rubberwood not available in 4-3/4"
Other Species available upon request

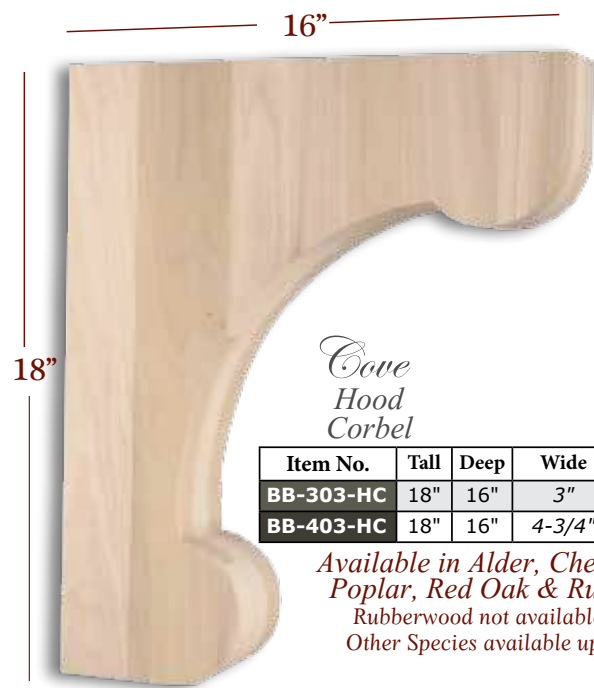

Cove
Hood
Corbel

Item No.	Tall	Deep	Wide	Description
BB-303-HC	18"	16"	3"	Hood Corbel
BB-403-HC	18"	16"	4-3/4"	Hood Corbel

Available in Alder, Cherry, Maple, Poplar, Red Oak & Rubberwood
Rubberwood not available in 4-3/4"
Other Species available upon request



Cove
Overhang
Bracket

Item No.	Tall	Deep	Wide	Description
BB-003-OH	9-3/4"	9-3/4"	1-3/4"	Overhang
BB-303-OH	9-3/4"	9-3/4"	3"	Overhang
BB-403-OH	9-3/4"	9-3/4"	4-3/4"	Overhang

Available in Alder, Cherry, Maple, Poplar, Red Oak & Rubberwood
Rubberwood not available in 4-3/4"
Other Species available upon request



Large Medium Small Extra Small

	Item No.	Tall	Deep	Wide	Description
1-3/4" W	BB-003-L	12-5/8"	8"	1-3/4"	Large
	BB-003-M	9-1/2"	4-7/8"	1-3/4"	Medium
	BB-003-S	8"	5"	1-3/4"	Small
	BB-003-XS	6-3/8"	4"	1-3/4"	Extra Small
3" W	BB-303-L	12-5/8"	8"	3"	Large
	BB-303-M	9-1/2"	4-7/8"	3"	Medium
	BB-303-S	8"	5"	3"	Small
	BB-303-XS	6-3/8"	4"	3"	Extra Small
4-3/4" W	BB-403-L	12-5/8"	8"	4-3/4"	Large
	BB-403-M	9-1/2"	4-7/8"	4-3/4"	Medium
	BB-403-S	8"	5"	4-3/4"	Small
	BB-403-XS	6-3/8"	4"	4-3/4"	Extra Small



"Leading the Pack"

GEORGIAN FAMILY

Family Suites

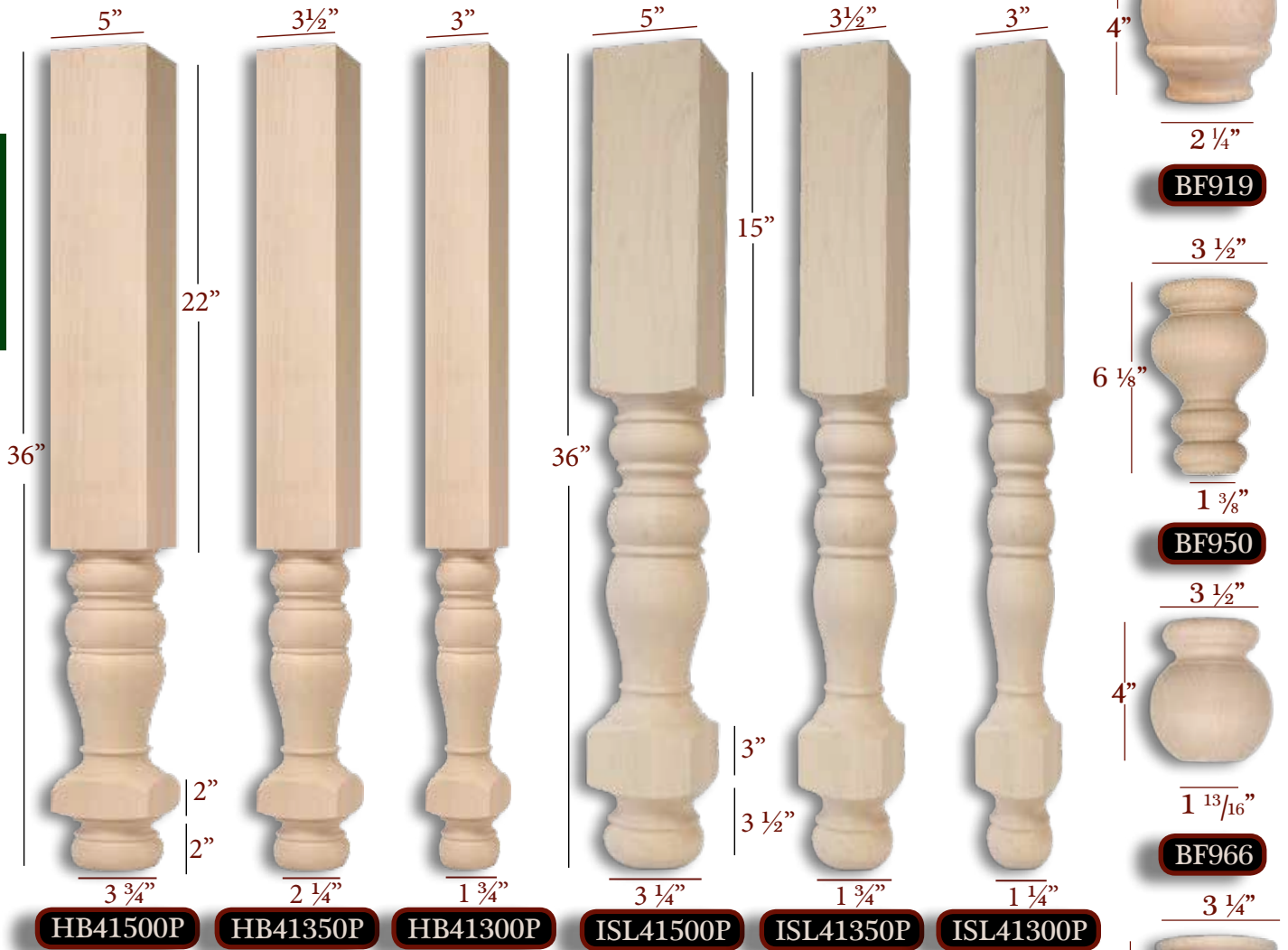

HB Legs Available in 2-1/4" x 34-1/2" Vanity Leg
See Page 143

Legs Available in 29" See Page 163

Item No.	Desc.	Tall	Overall Width	Top Shank Length	Block	Toe
HB41300P	Plain	36"	3"	22"	2"	1-3/4"
HB41350P	Plain	36"	3-1/2"	22"	2"	2-1/4"
HB41500P	Plain	36"	5"	22"	2"	3-3/4"
ISL41300P	Plain	36"	3"	15"	3"	1-1/4"
ISL41350P	Plain	36"	3-1/2"	15"	3"	1-3/4"
ISL41500P	Plain	36"	5"	15"	3"	3-1/4"
BF919	Plain	4"	3-1/2"	N/A	N/A	2-1/4"
BF950	Plain	6-1/8"	3-1/2"	N/A	N/A	1-3/8"
BF966	Plain	4"	3-1/2"	N/A	N/A	1-13/16"
BFS41S	Plain	4"	3-1/4"	N/A	N/A	1-1/2"
BFS41L	Plain	4"	4-3/4"	N/A	N/A	3"

Available in Alder, Cherry, Maple,
Poplar, Red Oak & Rubberwood
Other Species upon request

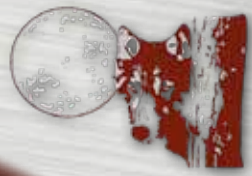

GEORGIAN FAMILY

Family Suites

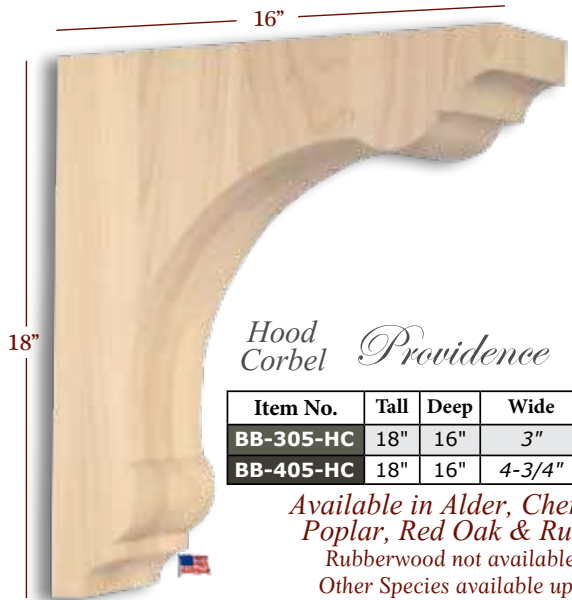

Hood Corbel *Providence*

Item No.	Tall	Deep	Wide	Description
BB-305-HC	18"	16"	3"	Hood Corbel
BB-405-HC	18"	16"	4-3/4"	Hood Corbel

Available in Alder, Cherry, Maple, Poplar, Red Oak & Rubberwood
 Rubberwood not available in 4-3/4"
 Other Species available upon request

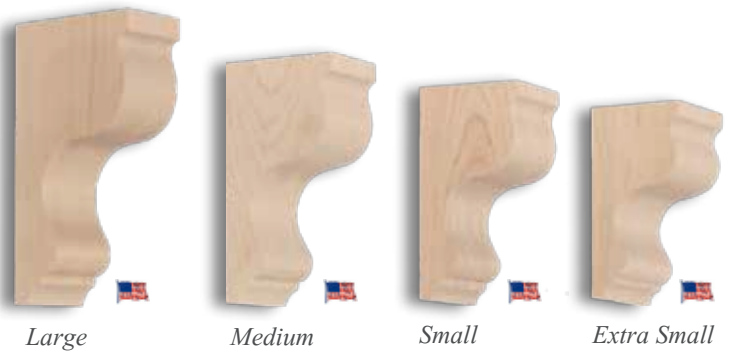

Bar Brackets *Providence*

	Item No.	Tall	Deep	Wide	Description
1-3/4" W	BB-005-L	12-1/2"	6-1/2"	1-3/4"	Large
	BB-005-M	9-9/16"	5"	1-3/4"	Medium
	BB-005-S	7-3/4"	4"	1-3/4"	Small
	BB-005-XS	6-5/16"	3-1/4"	1-3/4"	Extra Small
3" W	BB-305-L	12-1/2"	6-1/2"	3"	Large
	BB-305-M	9-9/16"	5"	3"	Medium
	BB-305-S	7-3/4"	4"	3"	Small
	BB-305-XS	6-5/16"	3-1/4"	3"	Extra Small
4-3/4" W	BB-405-L	12-1/2"	6-1/2"	4-3/4"	Large
	BB-405-M	9-9/16"	5"	4-3/4"	Medium
	BB-405-S	7-3/4"	4"	4-3/4"	Small
	BB-405-XS	6-5/16"	3-1/4"	4-3/4"	Extra Small

Available in Alder, Cherry, Maple, Poplar, Red Oak & Rubberwood
 Rubberwood not available in 4-3/4"
 Other Species available upon request

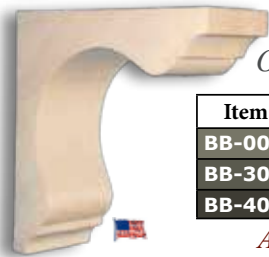

Overhang Bracket *Providence*

Item No.	Tall	Deep	Wide	Description
BB-005-OH	10"	10"	1-3/4"	Overhang
BB-305-OH	10"	10"	3"	Overhang
BB-405-OH	10"	10"	4-3/4"	Overhang

Available in Alder, Cherry, Maple, Poplar, Red Oak & Rubberwood
 Rubberwood not available in 4-3/4"
 Other Species available upon request



CBL-PT3



CBL-PT2



CBL-PT1



CBL-PT4



CBL-PT5

Traditional

Item No.	Tall	Deep	Wide	Description	Species
CBL-PT1	10"	5-1/4"	4-1/2"	Corbel - Small Trad. Corbel	These Items are available in Alder, Cherry, Maple, Red Oak, & Rubberwood
CBL-PT2	14"	7"	5"	Corbel - Medium Trad. Corbel	
CBL-PT3	22"	7-5/8"	6-3/4"	Corbel - Large Trad. Corbel	
CBL-PT4	13"	7-3/4"	3-3/8"	Corbel - Traditional Bar Bracket	
CBL-PT5	4-1/4"	1-3/4"	2-7/8"	Corbel - Mini Traditional	

"Leading the Pack"

HAMILTON FAMILY

Family Suites

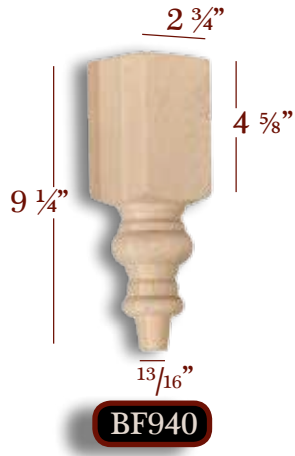
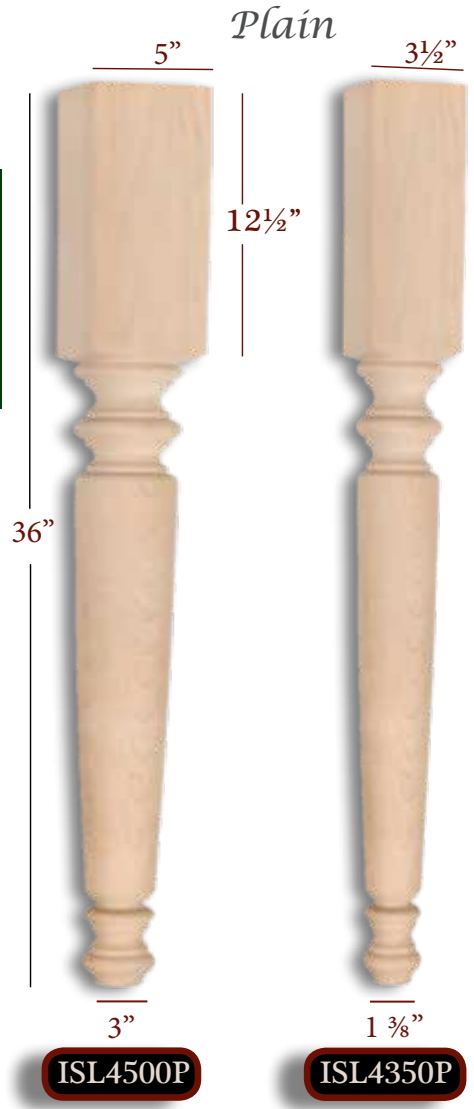

Legs Available in Alder, Cherry, Maple, Pine, Poplar, Red Oak & Rubberwood
Other Species upon request

Legs Available in Alder, Cherry, Maple, Poplar, Red Oak & Rubberwood
Other Species upon request

*Legs also available in Roped & Reeded
Other Sizes available are 18", 21" & 29"
See Pages 164-166

Item No.	Description	Tall	Overall Width	Top Shank Length	Toe
ISL4350E	Reeded	36"	3-1/2"	12-1/2"	1-3/8"
ISL4500E	Reeded	36"	5"	12-1/2"	3"
ISL4350P	Plain	36"	3-1/2"	12-1/2"	1-3/8"
ISL4500P	Plain	36"	5"	12-1/2"	3"
ISL4350R	Roped	36"	3-1/2"	12-1/2"	1-3/8"
ISL4500R	Roped	36"	5"	12-1/2"	3"
BF903	Plain	5-1/2"	3-5/8"	N/A	1-1/16"
BF913	Plain	9-1/8"	3-3/8"	N/A	7/8"
BF931	Plain	4-1/2"	2-3/4"	N/A	1-3/8"
BF940	Plain	9-1/4"	2-3/4"	N/A	13/16"
BF953	Plain	5-3/4"	4-3/8"	N/A	1-1/4"
BF-P002	Plain	4"	3-5/8"	N/A	1-3/16"

HAMILTON FAMILY

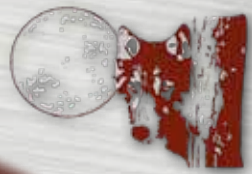

Hood Corbel *Plain*

Item No.	Tall	Deep	Wide	Description
BB-301-HC	18"	16"	3"	Hood Corbel
BB-401-HC	18"	16"	4-3/4"	Hood Corbel

Available in Alder, Cherry, Maple, Poplar, Red Oak & Rubberwood
 Rubberwood not available in 4-3/4"
 Other Species available upon request



Overhang Bracket *Plain*

Item No.	Tall	Deep	Wide	Description
BB-001-OH	10"	10"	1-3/4"	Overhang
BB-301-OH	10"	10"	3"	Overhang
BB-401-OH	10"	10"	4-3/4"	Overhang

Available in Alder, Cherry, Maple, Poplar, Red Oak & Rubberwood
 Rubberwood not available in 4-3/4"
 Other Species available upon request



Traditional
 CBL-WC13

Item No.	Tall	Deep	Wide
CBL-WC13	9-3/4"	5-5/8"	4-1/2"

Available in Rubberwood Only



Traditional
 CBL-PT5

Item No.	Tall	Deep	Wide
CBL-PT5	4-1/4"	1-3/4"	2-7/8"

Available in Alder, Cherry, Maple, Red Oak & Rubberwood

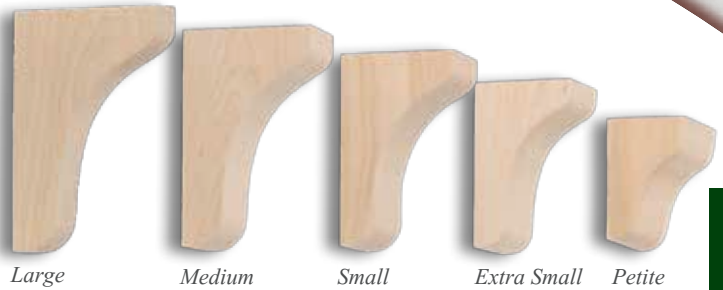

Bar Brackets *Plain*

	Item No.	Tall	Deep	Wide	Description
1-3/4" W	BB-001-L	12-7/8"	8"	1-3/4"	Large
	BB-001-M	9-5/8"	6"	1-3/4"	Medium
	BB-001-S	8-1/16"	5"	1-3/4"	Small
	BB-001-XS	6-1/2"	4"	1-3/4"	Extra Small
	BB-001-P	3"	1-1/2"	1-3/4"	Petite

	Item No.	Tall	Deep	Wide	Description
3" W	BB-301-L	12-7/8"	8"	3"	Large
	BB-301-M	9-5/8"	6"	3"	Medium
	BB-301-S	8-1/16"	5"	3"	Small
	BB-301-XS	6-1/2"	4"	3"	Extra Small
	BB-301-P	3"	1-1/2"	3"	Petite

	Item No.	Tall	Deep	Wide	Description
4-3/4" W	BB-401-L	12-7/8"	8"	4-3/4"	Large
	BB-401-M	9-5/8"	6"	4-3/4"	Medium
	BB-401-S	8-1/16"	5"	4-3/4"	Small
	BB-401-XS	6-1/2"	4"	4-3/4"	Extra Small
	BB-401-P	3"	1-1/2"	4-3/4"	Petite

Available in Alder, Cherry, Maple, Poplar, Red Oak & Rubberwood
 Rubberwood not available in 4-3/4"
 Other Species available upon request



CBL-WC12-5.75

CBL-WC12-4.5

CBL-WC12

CBL-WC12F

Item No.	Description	Tall	Deep	Wide
CBL-WC12	Plain	12"	6-1/2"	3"
CBL-WC12-4.5	Plain	12"	6-1/2"	4-1/2"
CBL-WC12-5.75	Plain	12"	6-1/2"	5-3/4"
CBL-WC12F	Fluted	12"	6-1/2"	3"

Available in Alder, Cherry, Maple, Red Oak & Rubberwood

"Leading the Pack"

HARVEST FAMILY

Family Suites



Harvest Family Legs available in Alder, Cherry, Maple, Poplar, Red Oak & Rubberwood
Other Species upon request

Harvest Family Bun Feet available in Alder, Cherry, Maple, Pine, Poplar, Red Oak & Rubberwood
Other Species upon request

 Harvest Series Legs are also available in 18", 21" & 29"
See Pages 167-170

Item No.	Description	Tall	Overall Width	Top Shank Length	Toe
ISL2375F	Fluted	36"	3-3/4"	14-3/4"	2-1/4"
ISL2500F	Fluted	36"	5"	14-3/4"	3-1/8"
ISL2375P	Plain	36"	3-3/4"	14-3/4"	2-1/4"
ISL2500P	Plain	36"	5"	14-3/4"	3-1/8"
ISL2375R	Roped	36"	3-3/4"	14-3/4"	2-1/4"
ISL2500R	Roped	36"	5"	14-3/4"	3-1/8"
BF916	Roped	5-1/2"	3-1/2"	N/A	1-1/16"
BF945	Roped	5"	3-1/2"	N/A	1-5/8"
BF960	Plain	4-1/2"	3-1/2"	N/A	1-1/2"
BF963	Plain	4"	3-1/2"	N/A	1-1/2"
BF-P002	Plain	4"	3-5/8"	N/A	1-3/16"

sales@TimberWolfForest.com
Phone: 877-504-WOLF
(9653)



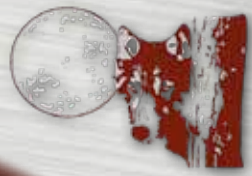

HARVEST FAMILY

Family Suites

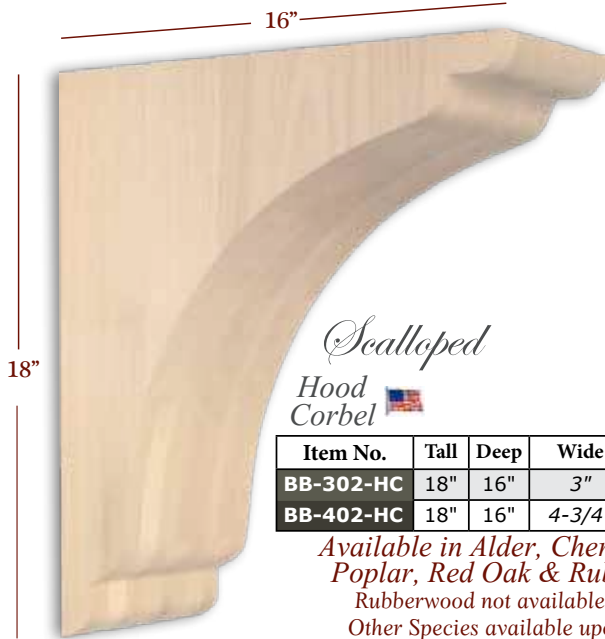

Scalloped
Hood Corbel

Item No.	Tall	Deep	Wide	Description
BB-302-HC	18"	16"	3"	Hood Corbel
BB-402-HC	18"	16"	4-3/4"	Hood Corbel

Available in Alder, Cherry, Maple, Poplar, Red Oak & Rubberwood
Rubberwood not available in 4-3/4"
Other Species available upon request

Scalloped
Bar Brackets

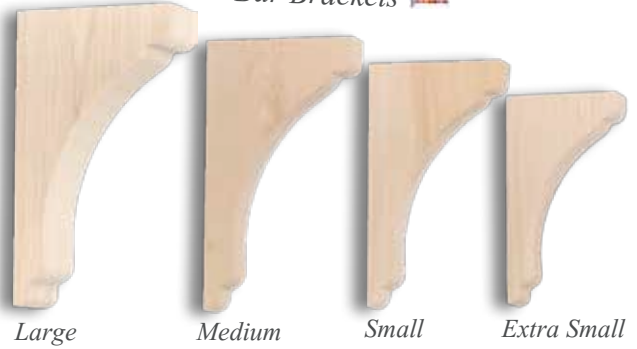

	Item No.	Tall	Deep	Wide	Description
1-3/4" W	BB-002-L	14-5/32"	8"	1-3/4"	Large
	BB-002-M	10-5/8"	5-1/2"	1-3/4"	Medium
	BB-002-S	9"	5"	1-3/4"	Small
	BB-002-XS	7-3/16"	4"	1-3/4"	Extra Small
3" W	BB-302-L	14-5/32"	8"	3"	Large
	BB-302-M	10-5/8"	5-1/2"	3"	Medium
	BB-302-S	9"	5"	3"	Small
	BB-302-XS	7-3/16"	4"	3"	Extra Small
4-3/4" W	BB-402-L	14-5/32"	8"	4-3/4"	Large
	BB-402-M	10-5/8"	5-1/2"	4-3/4"	Medium
	BB-402-S	9"	5"	4-3/4"	Small
	BB-402-XS	7-3/16"	4"	4-3/4"	Extra Small

Available in Alder, Cherry, Maple, Poplar, Red Oak & Rubberwood
Rubberwood not available in 4-3/4"
Other Species available upon request



Scalloped
Overhang Bracket

Item No.	Tall	Deep	Wide	Description
BB-002-OH	10"	10"	1-3/4"	Overhang
BB-302-OH	10"	10"	3"	Overhang
BB-402-OH	10"	10"	4-3/4"	Overhang

Available in Alder, Cherry, Maple, Poplar, Red Oak & Rubberwood
Rubberwood not available in 4-3/4"
Other Species available upon request



Athena
CBL-001-L

Athena
CBL-001-M

Athena
CBL-001-S

Item No.	Tall	Deep	Wide
CBL-001-S	6-3/4"	3-3/4"	3-1/2"
CBL-001-M	10"	5"	5"
CBL-001-L	14"	7"	5-1/4"

Available in Alder, Cherry, Maple, Poplar & Red Oak



CBL-WC12-5.75

CBL-WC12-4.5

CBL-WC12

CBL-WC12F
Fluted

Traditional

Item No.	Description	Tall	Deep	Wide
CBL-WC12	Plain	12"	6-1/2"	3"
CBL-WC12-4.5	Plain	12"	6-1/2"	4-1/2"
CBL-WC12-5.75	Plain	12"	6-1/2"	5-3/4"
CBL-WC12F	Fluted	12"	6-1/2"	3"

Available in Alder, Cherry, Maple, Red Oak & Rubberwood

"Leading the Pack"

JAMESTOWN FAMILY

Plain

Family Suites

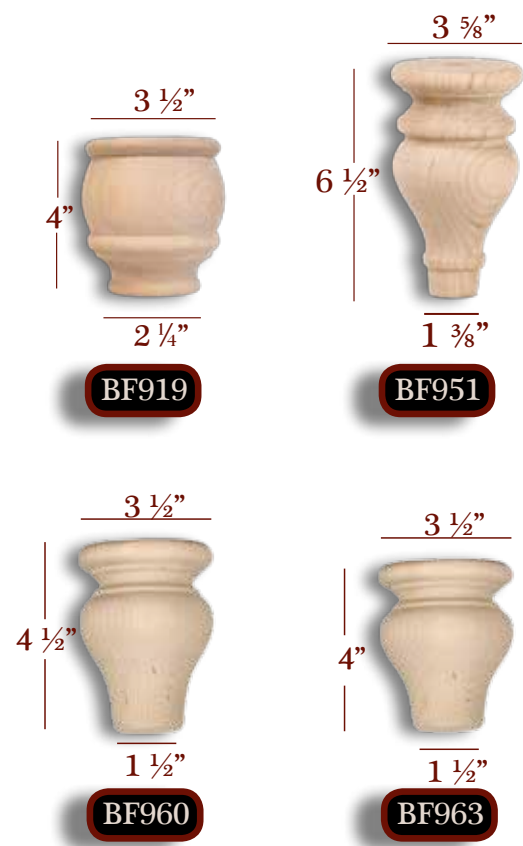
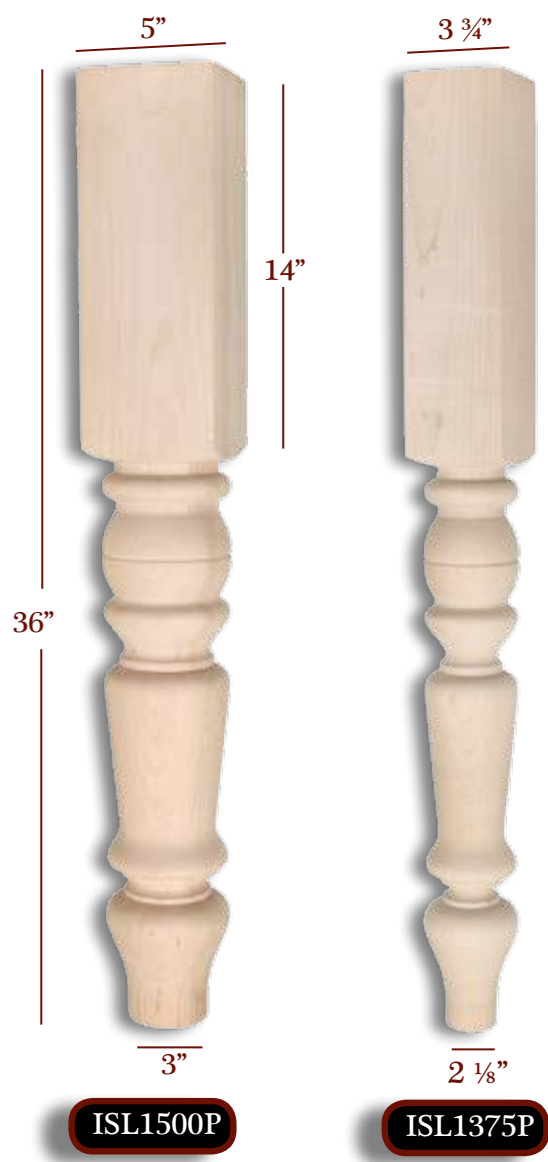

Harvest Family Bun Feet available in Alder, Cherry, Maple, Pine, Poplar, Red Oak & Rubberwood Other Species upon request

Harvest Family Legs available in Alder, Cherry, Maple, Poplar, Red Oak & Rubberwood Other Species upon request

 Jamestown Series Legs are also available in 29" See Page 171

Item No.	Description	Tall	Overall Width	Top Shank Length	Bottom Shank Length	Toe
ISL1375P	Plain	36"	3-3/4"	14"	N/A	2-1/8"
ISL1500P	Plain	36"	5"	14"	N/A	3"
BF919	Plain	4"	3-1/2"	N/A	N/A	2-1/4"
BF951	Plain	6-1/2"	3-5/8"	N/A	N/A	1-3/8"
BF960	Plain	4-1/2"	3-1/2"	N/A	N/A	1-1/2"
BF963	Plain	4"	3-1/2"	N/A	N/A	1-1/2"

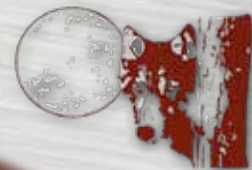

JAMESTOWN FAMILY

Family Suites

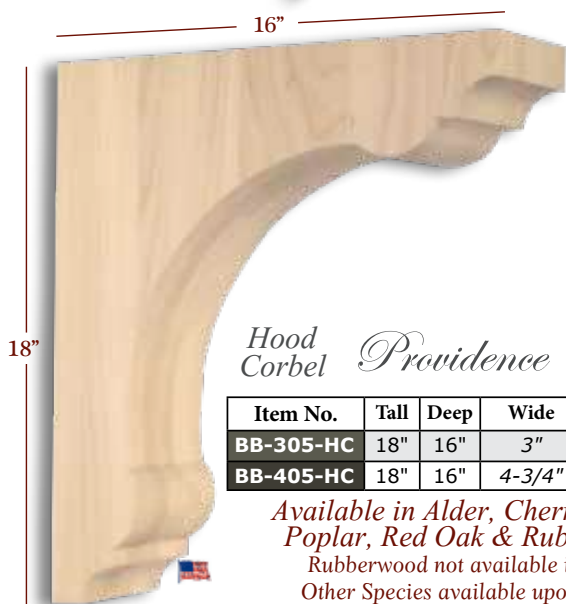

Hood Corbel Providence

Item No.	Tall	Deep	Wide	Description
BB-305-HC	18"	16"	3"	Hood Corbel
BB-405-HC	18"	16"	4-3/4"	Hood Corbel

Available in Alder, Cherry, Maple, Poplar, Red Oak & Rubberwood
 Rubberwood not available in 4-3/4"
 Other Species available upon request

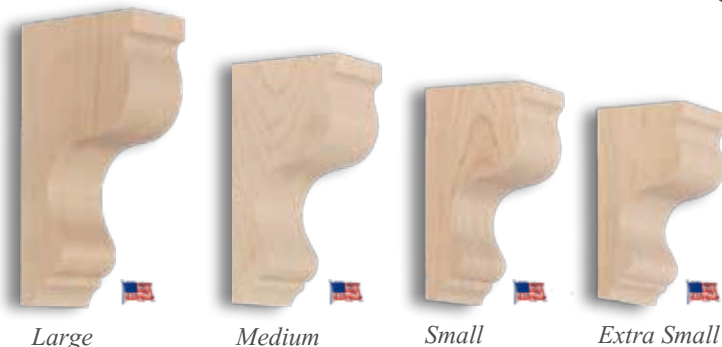

Bar Brackets Providence

	Item No.	Tall	Deep	Wide	Description
1-3/4" W	BB-005-L	12-1/2"	6-1/2"	1-3/4"	Large
	BB-005-M	9-9/16"	5"	1-3/4"	Medium
	BB-005-S	7-3/4"	4"	1-3/4"	Small
	BB-005-XS	6-5/16"	3-1/4"	1-3/4"	Extra Small
3" W	BB-305-L	12-1/2"	6-1/2"	3"	Large
	BB-305-M	9-9/16"	5"	3"	Medium
	BB-305-S	7-3/4"	4"	3"	Small
	BB-305-XS	6-5/16"	3-1/4"	3"	Extra Small
4-3/4" W	BB-405-L	12-1/2"	6-1/2"	4-3/4"	Large
	BB-405-M	9-9/16"	5"	4-3/4"	Medium
	BB-405-S	7-3/4"	4"	4-3/4"	Small
	BB-405-XS	6-5/16"	3-1/4"	4-3/4"	Extra Small

Available in Alder, Cherry, Maple, Poplar, Red Oak & Rubberwood
 Rubberwood not available in 4-3/4"
 Other Species available upon request

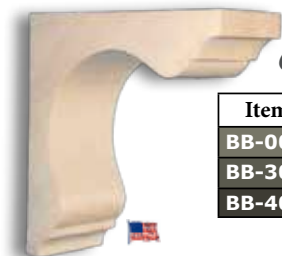

Overhang Bracket Providence

Item No.	Tall	Deep	Wide	Description
BB-005-OH	10"	10"	1-3/4"	Overhang
BB-305-OH	10"	10"	3"	Overhang
BB-405-OH	10"	10"	4-3/4"	Overhang

Available in Alder, Cherry, Maple, Poplar, Red Oak & Rubberwood
 Rubberwood not available in 4-3/4"
 Other Species available upon request



CBL-PT3



CBL-PT2



CBL-PT1



CBL-PT4



CBL-PT5

Traditional

Item No.	Tall	Deep	Wide	Description	Species
CBL-PT1	10"	5-1/4"	4-1/2"	Corbel - Small Trad. Corbel	These Items are available in Alder, Cherry, Maple, Red Oak, & Rubberwood
CBL-PT2	14"	7"	5"	Corbel - Medium Trad. Corbel	
CBL-PT3	22"	7-5/8"	6-3/4"	Corbel - Large Trad. Corbel	
CBL-PT4	13"	7-3/4"	3-3/8"	Corbel - Traditional Bar Bracket	
CBL-PT5	4-1/4"	1-3/4"	2-7/8"	Corbel - Mini Traditional	

"Leading the Pack"

KIMERICK FAMILY

Family Suites



Item No.	Description	Tall	Overall Width	Top Shank Length	Bottom Shank Length	Toe
BAR30300E	Reeded	42"	3"	6-3/4"	6"	N/A
BAR30300P	Plain	42"	3"	6-3/4"	6"	N/A
BAR30350E	Reeded	42"	3-1/2"	6-3/4"	6"	N/A
BAR30350P	Plain	42"	3-1/2"	6-3/4"	6"	N/A
BAR30500E	Reeded	42"	5"	6-3/4"	6"	N/A
BAR30500P	Plain	42"	5"	6-3/4"	6"	N/A
ISL30300E	Reeded	36"	3"	6-3/4"	6"	N/A
ISL30300P	Plain	36"	3"	6-3/4"	6"	N/A
ISL30350E	Reeded	36"	3-1/2"	6-3/4"	6"	N/A
ISL30350P	Plain	36"	3-1/2"	6-3/4"	6"	N/A
ISL30500E	Reeded	36"	5"	6-3/4"	6"	N/A
ISL30500P	Plain	36"	5"	6-3/4"	6"	N/A
BF903	Plain	5-1/2"	3-5/8"	N/A	N/A	1-1/16"
BF912	Reeded	9-1/8"	3-3/8"	N/A	N/A	7/8"
BF913	Plain	9-1/8"	3-3/8"	N/A	N/A	7/8"
BF983	Reeded	4-1/2"	4-1/2"	N/A	N/A	2-1/8"
BF990	Plain	3-3/4"	4-3/4"	N/A	N/A	3-1/2"

Available in Alder, Cherry, Maple, Poplar, Red Oak & Rubberwood
Other Species upon request

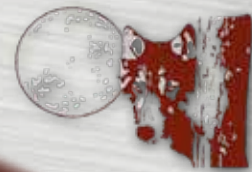

KIMERICK FAMILY

Family Suites



Hood Corbel *Nantucket*

Item No.	Tall	Deep	Wide	Description
BB-309-HC	18"	16"	3"	Hood Corbel
BB-409-HC	18"	16"	4-3/4"	Hood Corbel

Available in Alder, Cherry, Maple, Poplar, Red Oak & Rubberwood
 Rubberwood not available in 4-3/4"
 Other Species available upon request



Overhang Bracket *Nantucket*

Item No.	Tall	Deep	Wide	Description
BB-009-OH	10"	10"	1-3/4"	Overhang
BB-309-OH	10"	10"	3"	Overhang
BB-409-OH	10"	10"	4-3/4"	Overhang

Available in Alder, Cherry, Maple, Poplar, Red Oak & Rubberwood
 Rubberwood not available in 4-3/4"
 Other Species available upon request

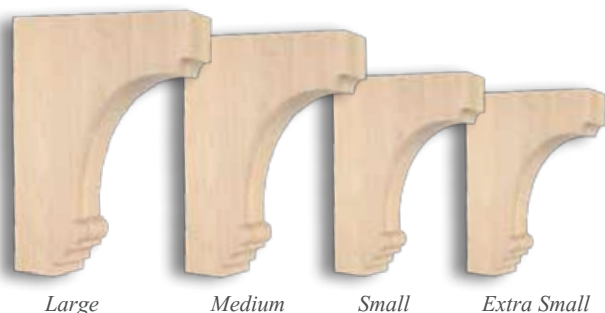

Bar Brackets *Nantucket*

	Item No.	Tall	Deep	Wide	Description
1-3/4" W	BB-009-L	12"	8"	1-3/4"	Large
	BB-009-M	9"	6-1/2"	1-3/4"	Medium
	BB-009-S	7-1/2"	5"	1-3/4"	Small
	BB-009-XS	6"	4"	1-3/4"	Extra Small
3" W	BB-309-L	12"	8"	3"	Large
	BB-309-M	9"	6-1/2"	3"	Medium
	BB-309-S	7-1/2"	5"	3"	Small
	BB-309-XS	6"	4"	3"	Extra Small
4-3/4" W	BB-409-L	12"	8"	4-3/4"	Large
	BB-409-M	9"	6-1/2"	4-3/4"	Medium
	BB-409-S	7-1/2"	5"	4-3/4"	Small
	BB-409-XS	6"	4"	4-3/4"	Extra Small

Available in Alder, Cherry, Maple, Poplar, Red Oak & Rubberwood
 Rubberwood not available in 4-3/4"
 Other Species available upon request



Mission
CBL-PM4

Item No.	Tall	Deep	Wide
CBL-PM4	12"	6-1/2"	2-1/2"

Available in Alder, Cherry, Maple, Red Oak & Rubberwood

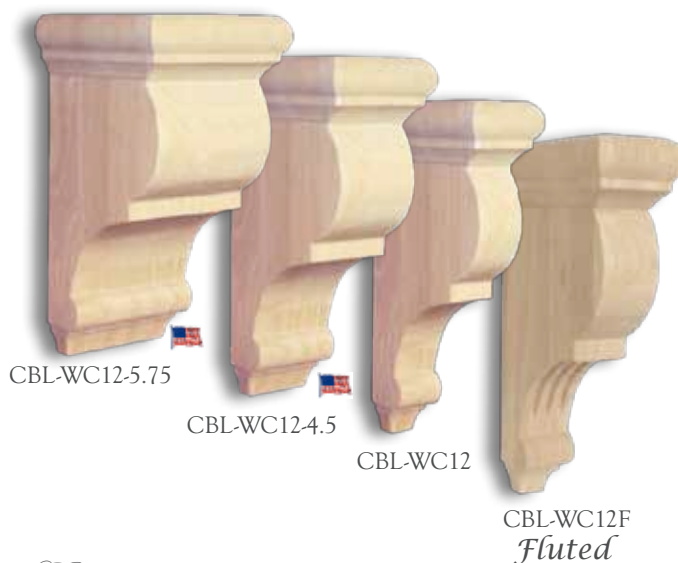

Traditional

Item No.	Description	Tall	Deep	Wide
CBL-WC12	Plain	12"	6-1/2"	3"
CBL-WC12-4.5	Plain	12"	6-1/2"	4-1/2"
CBL-WC12-5.75	Plain	12"	6-1/2"	5-3/4"
CBL-WC12F	Fluted	12"	6-1/2"	3"

Available in Alder, Cherry, Maple, Red Oak & Rubberwood

"Leading the Pack"

KINGSTON FAMILY ❁

Family Suites



Available in
Alder, Cherry,
Maple,
Poplar, Red
Oak &
Rubberwood
Other Species
upon request

Item No.	Tall	Overall Width	Top Shank Length	Toe
ISL5500E	36"	5"	11-1/8"	2-1/8"
ISL5500P	36"	5"	11-1/8"	2-1/8"
BF910	2-3/4"	4-3/4"	N/A	2-13/16"
BF911	4-1/2"	4-3/4"	N/A	2-3/4"
BF912	9-1/8"	3-3/8"	N/A	7/8"
BF925	4"	4-3/4"	N/A	2-5/8"
BF930	5"	4"	N/A	7/8"
BF940	9-1/4"	2-3/4"	N/A	13/16"
BF953	5-3/4"	4-3/8"	N/A	1-1/4"
BF983	4-1/2"	4-1/2"	N/A	2-1/8"

❁ Kingston Series Legs
are also available in 29"
See Page 172

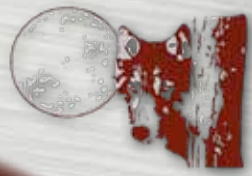

KINGSTON FAMILY

Family Suites



CBL-WC12F
Fluted



CBL-WC12-5.75

CBL-WC12-4.5

CBL-WC12

Traditional



Maverick
CBL-002-M

Item No.	Tall	Deep	Wide
CBL-002-M	10-1/16"	6"	3-1/2"

Available in Alder, Cherry, Maple,
Poplar & Red Oak
Other Species upon request

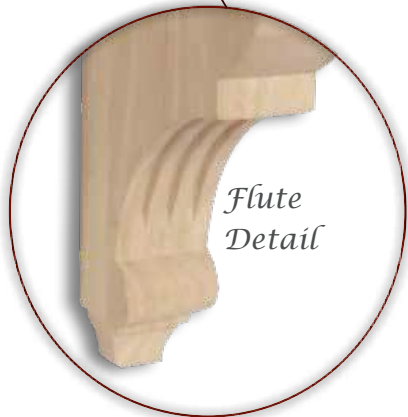

Flute
Detail

Item No.	Description	Tall	Deep	Wide
CBL-WC12	Plain	12"	6-1/2"	3"
CBL-WC12-4.5	Plain	12"	6-1/2"	4-1/2"
CBL-WC12-5.75	Plain	12"	6-1/2"	5-3/4"
CBL-WC12F	Fluted	12"	6-1/2"	3"

Available in Alder, Cherry, Maple,
Red Oak & Rubberwood



ISL5500E
Shown in Picture



Vita
CBL-003-M

Item No.	Tall	Deep	Wide
CBL-003-M	10"	6-7/16"	3"

Available in Alder, Cherry, Maple,
Poplar & Red Oak
Other Species upon request



CBL-PT3



CBL-PT2

Available in Alder, Cherry, Maple,
Poplar & Red Oak
Other Species upon request



CBL-PT1



CBL-PT4



CBL-PT5

Traditional

Item No.	Tall	Deep	Wide	Description	Species
CBL-PT1	10"	5-1/4"	4-1/2"	Corbel - Small Trad. Corbel	These Items are available in Alder, Cherry, Maple, Red Oak, & Rubberwood
CBL-PT2	14"	7"	5"	Corbel - Medium Trad. Corbel	
CBL-PT3	22"	7-5/8"	6-3/4"	Corbel - Large Trad. Corbel	
CBL-PT4	13"	7-3/4"	3-3/8"	Corbel - Traditional Bar Bracket	
CBL-PT5	4-1/4"	1-3/4"	2-7/8"	Corbel - Mini Traditional	

"Leading the Pack"

LAKELAND FAMILY

Family Suites

Plain

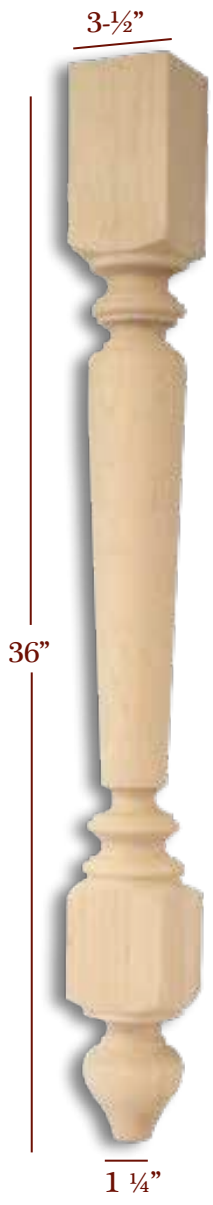

ISL38350P



ISL38500P



BF902



BF930



BF963



BF913



BF960



BF-P002

Available in Alder, Cherry, Maple, Poplar, Red Oak & Rubberwood
Other Species upon request

Item No.	Tall	Overall Width	Top Shank Length	Block	Toe
ISL38350P	36"	3-1/2"	6-1/2"	4-1/4"	1-1/4"
ISL38500P	36"	5"	6-1/2"	4-1/4"	2-3/4"
BF902	3"	3-5/8"	N/A	N/A	1-3/4"
BF913	9-1/8"	3-3/8"	N/A	N/A	7/8"
BF930	5"	4"	N/A	N/A	7/8"
BF960	4-1/2"	3-1/2"	N/A	N/A	1-1/2"
BF963	4"	3-1/2"	N/A	N/A	1-1/2"
BF-P002	4"	3-5/8"	N/A	N/A	1-3/16"

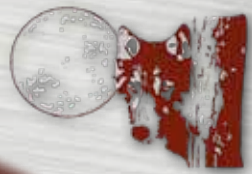

LAKELAND FAMILY

Family Suites

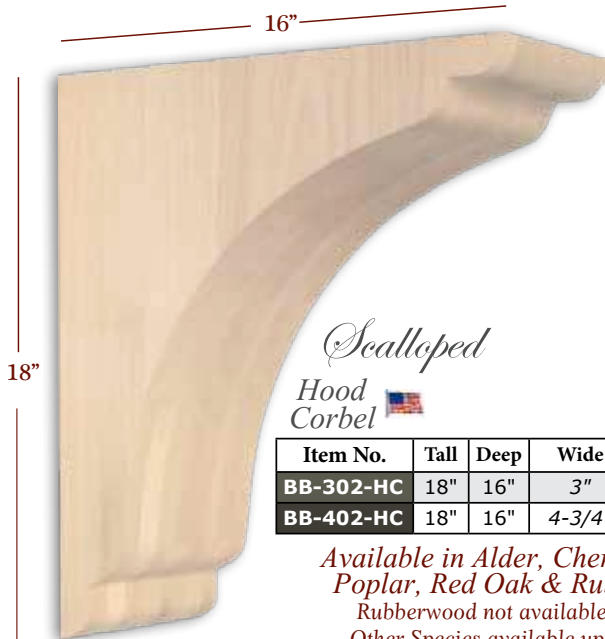

Scalloped
Hood Corbel

Item No.	Tall	Deep	Wide	Description
BB-302-HC	18"	16"	3"	Hood Corbel
BB-402-HC	18"	16"	4-3/4"	Hood Corbel

Available in Alder, Cherry, Maple, Poplar, Red Oak & Rubberwood
Rubberwood not available in 4-3/4"
Other Species available upon request



Scalloped
Overhang Bracket

Item No.	Tall	Deep	Wide	Description
BB-002-OH	10"	10"	1-3/4"	Overhang
BB-302-OH	10"	10"	3"	Overhang
BB-402-OH	10"	10"	4-3/4"	Overhang

Available in Alder, Cherry, Maple, Poplar, Red Oak & Rubberwood
Rubberwood not available in 4-3/4"
Other Species available upon request

Scalloped
Bar Brackets

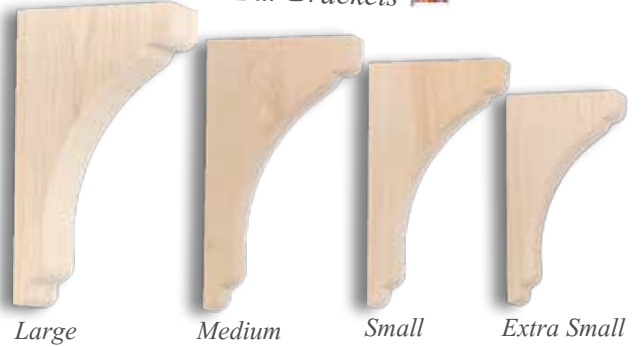

	Item No.	Tall	Deep	Wide	Description
1-3/4" W	BB-002-L	14-5/32"	8"	1-3/4"	Large
	BB-002-M	10-5/8"	5-1/2"	1-3/4"	Medium
	BB-002-S	9"	5"	1-3/4"	Small
	BB-002-XS	7-3/16"	4"	1-3/4"	Extra Small
3" W	BB-302-L	14-5/32"	8"	3"	Large
	BB-302-M	10-5/8"	5-1/2"	3"	Medium
	BB-302-S	9"	5"	3"	Small
	BB-302-XS	7-3/16"	4"	3"	Extra Small
4-3/4" W	BB-402-L	14-5/32"	8"	4-3/4"	Large
	BB-402-M	10-5/8"	5-1/2"	4-3/4"	Medium
	BB-402-S	9"	5"	4-3/4"	Small
	BB-402-XS	7-3/16"	4"	4-3/4"	Extra Small

Available in Alder, Cherry, Maple, Poplar, Red Oak & Rubberwood
Rubberwood not available in 4-3/4"
Other Species available upon request



Athena
CBL-001-L



Athena
CBL-001-M



Athena
CBL-001-S

Item No.	Tall	Deep	Wide
CBL-001-S	6-3/4"	3-3/4"	3-1/2"
CBL-001-M	10"	5"	5"
CBL-001-L	14"	7"	5-1/4"

Available in Alder, Cherry, Maple, Poplar & Red Oak



Traditional
CBL-PT5

Item No.	Tall	Deep	Wide
CBL-PT5	4-1/4"	1-3/4"	2-7/8"

Available in Alder, Cherry, Maple, Red Oak & Rubberwood



Traditional
CBL-PT4

Item No.	Tall	Deep	Wide
CBL-PT4	13"	7-3/4"	3-3/8"

Available in Alder, Cherry, Maple, Red Oak & Rubberwood

"Leading the Pack"

LIBERTY FAMILY

Plain Square

Family Suites

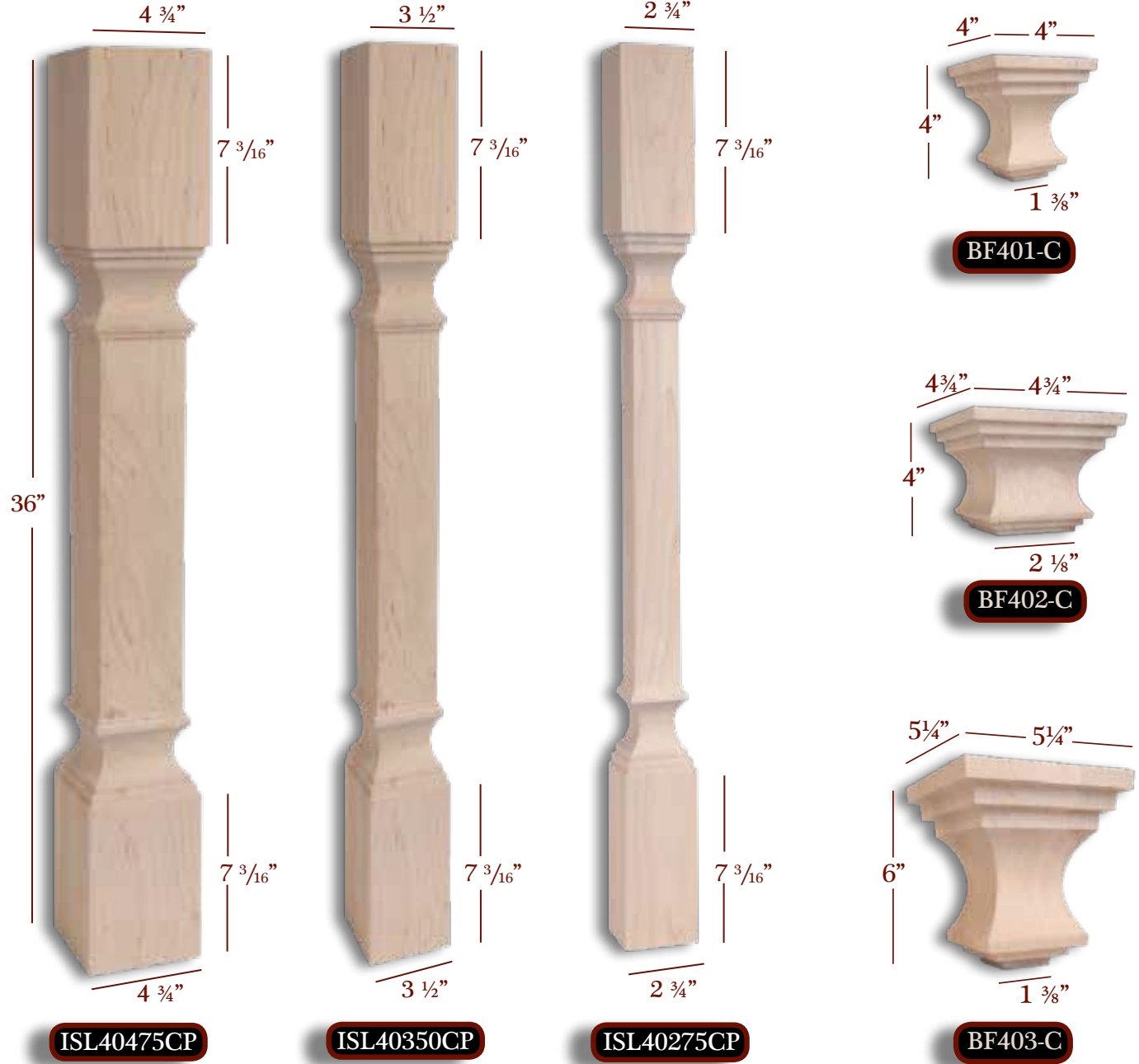

Item No.	Tall	Overall Width	Top Shank Length	Bottom Shank Length	Toe
ISL40275CP	36"	2-3/4"	7-3/16"	7-3/16"	N/A
ISL40350CP	36"	3-1/2"	7-3/16"	7-3/16"	N/A
ISL40475CP	36"	4-3/4"	7-3/16"	7-3/16"	N/A
BF401-C	4"	4"	N/A	N/A	1-3/8"
BF402-C	4"	4-3/4"	N/A	N/A	2-1/8"
BF403-C	6"	5-1/4"	N/A	N/A	1-3/8"

Available in Alder, Cherry, Maple, Poplar, Red Oak & Rubberwood
Other Species upon request

American Made

sales@TimberWolfForest.com
Phone: 877-504-WOLF
(9653)

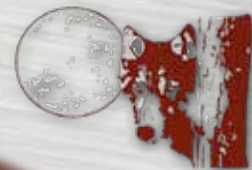

LIBERTY FAMILY

Plain Square

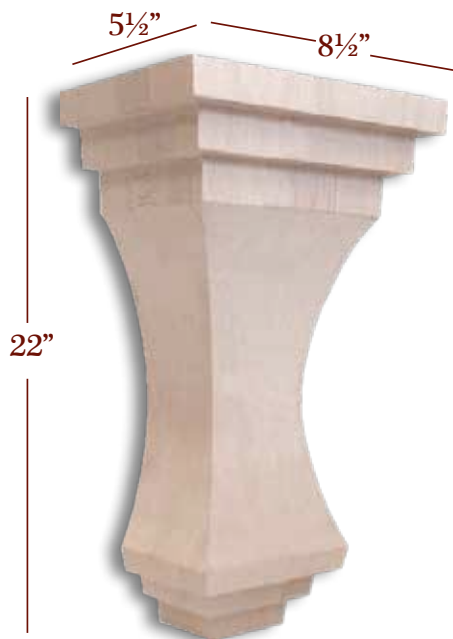

CBL-40-XL



CBL-40-L

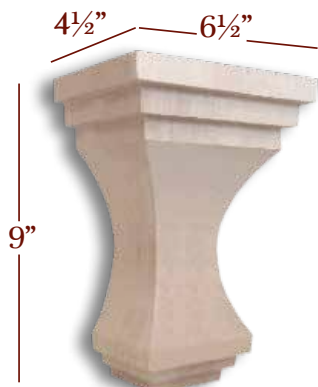

CBL-40-M



CBL-40-S



CBL-40-XS

Item No.	Tall	Deep	Wide	Description
CBL-40-XL	22"	5-1/2"	8-1/2"	Liberty Series - Extra Large Corbel
CBL-40-L	12"	5"	8"	Liberty Series - Large Corbel
CBL-40-M	9"	4-1/2"	6-1/2"	Liberty Series - Medium Corbel
CBL-40-S	6"	2-1/2"	5-1/4"	Liberty Series - Small Corbel
CBL-40-XS	4"	1-7/8"	4"	Liberty Series - Extra Small Corbel

*Available in Alder, Cherry, Maple,
Poplar, Red Oak & Rubberwood
Other Species upon request*

Family Suites



"Leading the Pack"

LINCOLN FAMILY

Family Suites



 *Lincoln Series Legs are also available in 15-1/2", 18, 21 & 29"*
See Page 173-175

Item No.	Description	Tall	Overall Width	Top Shank Length	Toe
ISL6300D	Diamond	36"	3"	13"	1-3/4"
ISL6300E	Reeded	36"	3"	13"	1-3/4"
ISL6300P	Plain	36"	3"	13"	1-3/4"
ISL6375D	Diamond	36"	3-3/4"	13"	2-1/2"
ISL6375E	Reeded	36"	3-3/4"	13"	2-1/2"
ISL6375P	Plain	36"	3-3/4"	13"	2-1/2"
ISL6500D	Diamond	36"	5"	13"	3-1/4"
ISL6500E	Reeded	36"	5"	13"	3-1/4"
ISL6500P	Plain	36"	5"	13"	3-1/4"

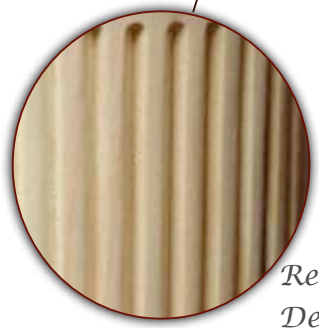

Reed Detail

*Available in Alder, Cherry, Maple, Poplar, Red Oak & Rubberwood
 Other Species upon request*

 American Made 

Phone: 877-504-WOLF
 (9653)
 sales@TimberWolfForest.com

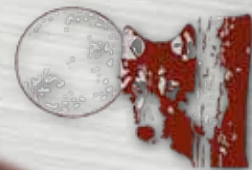

LINCOLN FAMILY

Family Suites



Lexington

Hood Corbel

Item No.	Tall	Deep	Wide	Description
BB-304-HC	18"	16"	3"	Hood Corbel
BB-404-HC	18"	16"	4-3/4"	Hood Corbel

Available in Alder, Cherry, Maple, Poplar, Red Oak & Rubberwood
 Rubberwood not available in 4-3/4"
 Other Species available upon request



Lexington

Overhang Bracket

Item No.	Tall	Deep	Wide	Description
BB-004-OH	10"	10"	1-3/4"	Overhang
BB-304-OH	10"	10"	3"	Overhang
BB-404-OH	10"	10"	4-3/4"	Overhang

Available in Alder, Cherry, Maple, Poplar, Red Oak & Rubberwood
 Rubberwood not available in 4-3/4"
 Other Species available upon request

Available in Alder, Cherry, Maple, Pine, Poplar & Red Oak
 Other Species upon request



Item No.	Description	Tall	Overall Width	Toe
BF902	Plain	3"	3-5/8"	1-3/4"
BF925	Plain	4"	4-3/4"	2-5/8"
BF960	Plain	4-1/2"	3-1/2"	1-1/2"
BF963	Plain	4"	3-1/2"	1-1/2"
BF983	Plain	4-1/2"	4-1/2"	2-1/8"

Lexington

Bar Brackets



	Item No.	Tall	Deep	Wide	Description
1-3/4" W	BB-004-L	12-3/4"	6-9/16"	1-3/4"	Large
	BB-004-M	9-1/2"	4-7/8"	1-3/4"	Medium
	BB-004-S	7-1/2"	4-1/4"	1-3/4"	Small
	BB-004-XS	6-1/8"	3-1/2"	1-3/4"	Extra Small
3" W	BB-304-L	12-3/4"	6-9/16"	3"	Large
	BB-304-M	9-1/2"	4-7/8"	3"	Medium
	BB-304-S	7-1/2"	4-1/4"	3"	Small
	BB-304-XS	6-1/8"	3-1/2"	3"	Extra Small
4-3/4" W	BB-404-L	12-3/4"	6-9/16"	4-3/4"	Large
	BB-404-M	9-1/2"	4-7/8"	4-3/4"	Medium
	BB-404-S	7-1/2"	4-1/4"	4-3/4"	Small
	BB-404-XS	6-1/8"	3-1/2"	4-3/4"	Extra Small

Available in Alder, Cherry, Maple, Poplar, Red Oak & Rubberwood
 Rubberwood not available in 4-3/4"
 Other Species available upon request

"Leading the Pack"

LIVINGSTON FAMILY

Plain Square

Family Suites

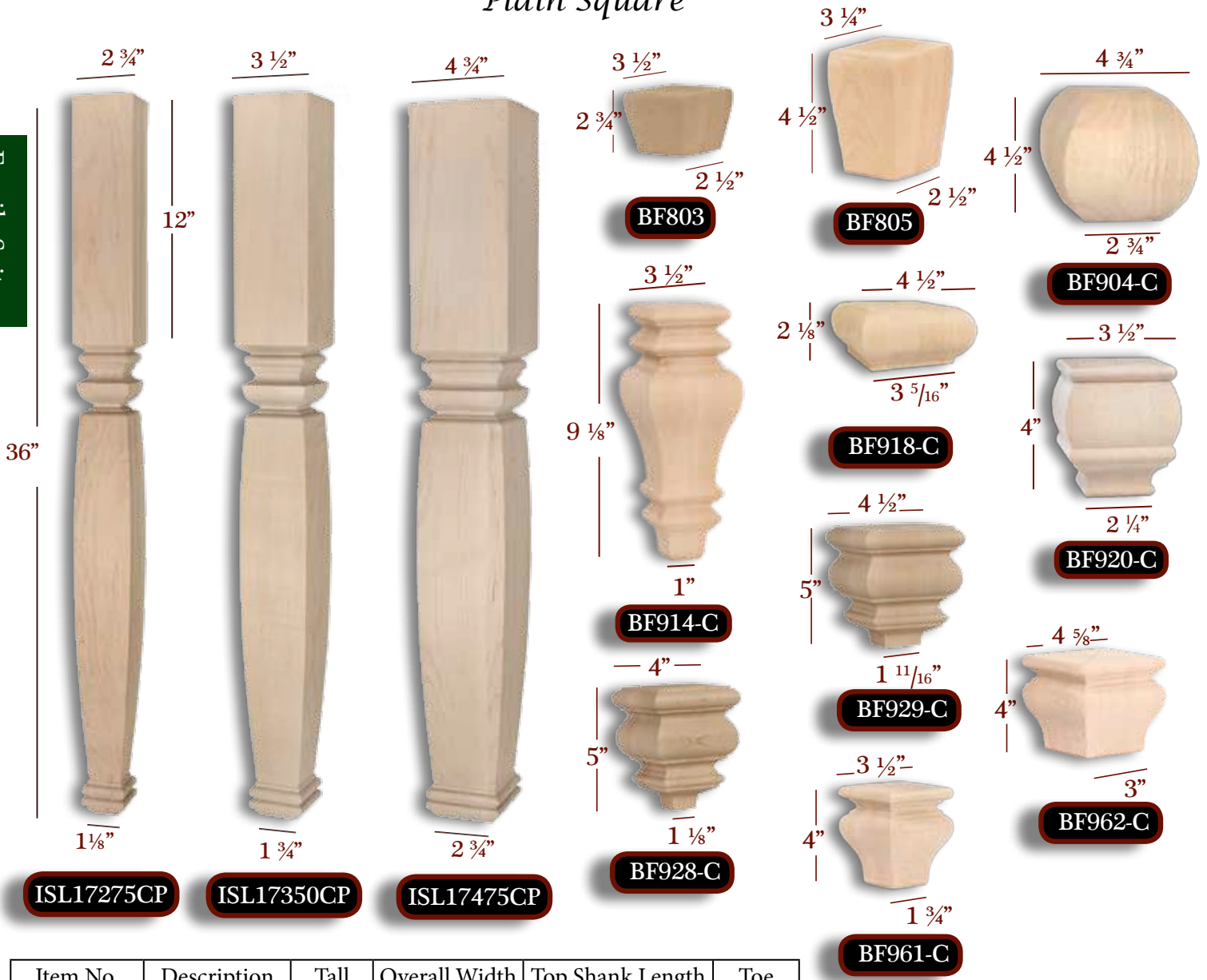

Item No.	Description	Tall	Overall Width	Top Shank Length	Toe
ISL17275CP	Plain Square	36"	2-3/4"	12"	1-1/8"
ISL17350CP	Plain Square	36"	3-1/2"	12"	1-3/4"
ISL17475CP	Plain Square	36"	4-3/4"	12"	2-3/4"
BF803	Plain Square	2-3/4"	3-1/2"	N/A	2-1/2"
BF805	Plain Square	4-1/2"	3-1/4"	N/A	2-1/2"
BF904-C	Plain Square	4-1/2"	4-3/4"	N/A	2-3/4"
BF914-C	Plain Square	9-1/8"	3-1/2"	N/A	1"
BF918-C	Plain Square	2-1/8"	4-1/2"	N/A	3-5/16"
BF920-C	Plain Square	4"	3-1/2"	N/A	2-1/4"
BF928-C	Plain Square	5"	4"	N/A	1-1/8"
BF929-C	Plain Square	5"	4-1/2"	N/A	1-11/16"
BF961-C	Plain Square	4"	3-1/2"	N/A	1-3/4"
BF962-C	Plain Square	4"	4-5/8"	N/A	3"

Available in Alder,
Cherry, Maple,
Poplar, Red Oak &
Rubberwood
Other Species upon
request

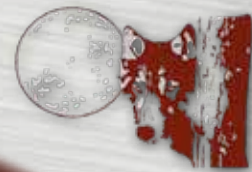

LIVINGSTON FAMILY

Family Suites

16"

18"

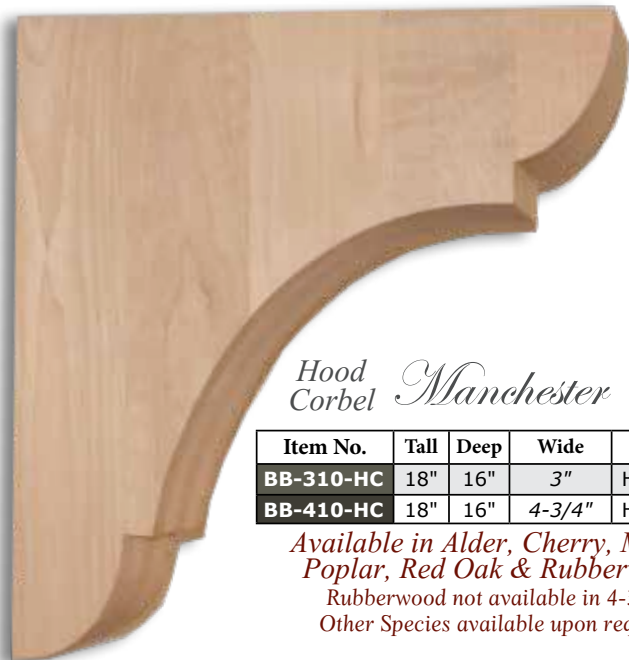

Hood Corbel *Manchester*

Item No.	Tall	Deep	Wide	Description
BB-310-HC	18"	16"	3"	Hood Corbel
BB-410-HC	18"	16"	4-3/4"	Hood Corbel

Available in Alder, Cherry, Maple, Poplar, Red Oak & Rubberwood
 Rubberwood not available in 4-3/4"
 Other Species available upon request



Overhang Bracket *Manchester*

Item No.	Tall	Deep	Wide	Description
BB-010-OH	10"	10"	1-3/4"	Overhang
BB-310-OH	10"	10"	3"	Overhang
BB-410-OH	10"	10"	4-3/4"	Overhang

Available in Alder, Cherry, Maple, Poplar, Red Oak & Rubberwood
 Rubberwood not available in 4-3/4"
 Other Species available upon request



CBL-006-M

Cape Cod

Item No.	Tall	Deep	Wide
CBL-006-M	10"	6-3/8"	3"

Available in Alder, Cherry, Maple, Poplar & Red Oak
 Other Species upon request

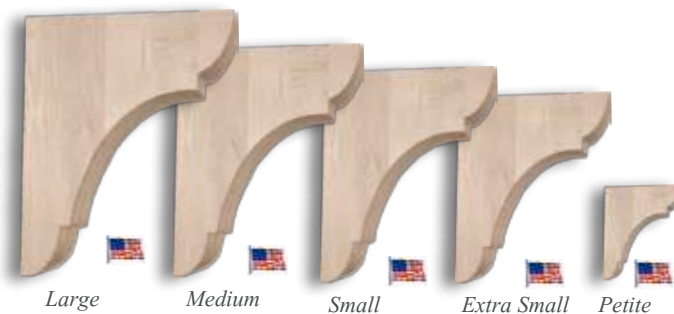

Bar Brackets *Manchester*

	Item No.	Tall	Deep	Wide	Description
1-3/4" W	BB-010-L	12"	8"	1-3/4"	Large
	BB-010-M	9"	6-1/2"	1-3/4"	Medium
	BB-010-S	7-1/2"	5"	1-3/4"	Small
	BB-010-XS	6"	4"	1-3/4"	Extra Small
	BB-010-P	3"	3"	1-3/4"	Petite
3" W	BB-310-L	12"	8"	3"	Large
	BB-310-M	9"	6-1/2"	3"	Medium
	BB-310-S	7-1/2"	5"	3"	Small
	BB-310-XS	6"	4"	3"	Extra Small
	BB-310-P	3"	3"	3"	Petite
4-3/4" W	BB-410-L	12"	8"	4-3/4"	Large
	BB-410-M	9"	6-1/2"	4-3/4"	Medium
	BB-410-S	7-1/2"	5"	4-3/4"	Small
	BB-410-XS	6"	4"	4-3/4"	Extra Small

Available in Alder, Cherry, Maple, Poplar, Red Oak & Rubberwood
 Rubberwood not available in 4-3/4"
 Other Species available upon request

ISL17300CP,
 ISL17500CP & ISL17375CP
 Shown in Picture



"Leading the Pack"

MADISON FAMILY

Family Suites

Plain

3"

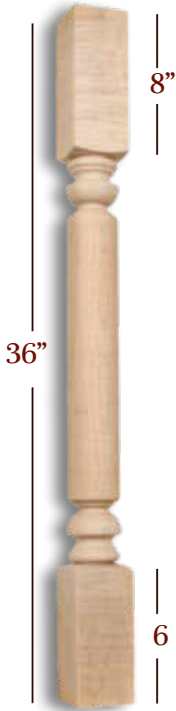

ISL8300P

Reeded

3 1/2"



ISL8350E

Posts Available in Alder, Cherry, Maple, Poplar, Red Oak & Rubberwood Other Species upon request

Roped

3"

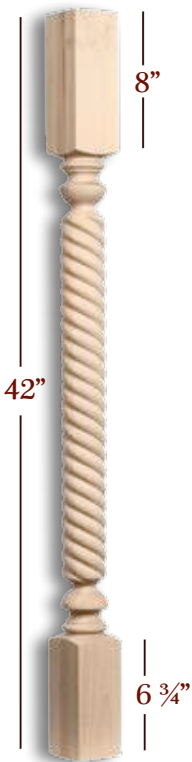

BAR8300R

Diamond

3 3/4"

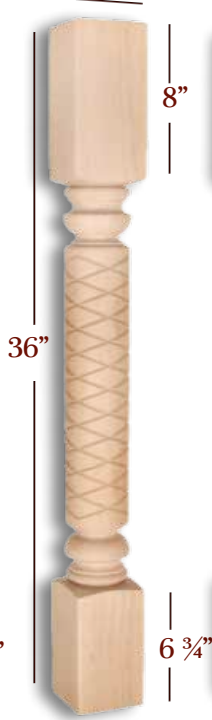

ISL8375D

Fluted

5"



ISL8500F

	Item No.	Description	Tall	Width	Top Shank Length	Bottom Shank Length
Diamond	BAR8300D	Diamond Round	42"	3"	8"	6-3/4"
	BAR8375D	Diamond Round	42"	3-3/4"	8"	6-3/4"
	BAR8500D	Diamond Round	42"	5"	8"	6-3/4"
	ISL8300D	Diamond Round	36"	3"	8"	6-3/4"
	ISL8375D	Diamond Round	36"	3-3/4"	8"	6-3/4"
Reeded	ISL8500D	Diamond Round	36"	5"	8"	6-3/4"
	BAR8300E	Reeded Round	42"	3"	8"	6-3/4"
	BAR8375E	Reeded Round	42"	3-3/4"	8"	6-3/4"
	BAR8500E	Reeded Round	42"	5"	8"	6-3/4"
	ISL8300E	Reeded Round	36"	3"	8"	6-3/4"
Fluted	ISL8350E	Reeded Round	36"	3-1/2"	8"	6-3/4"
	ISL8375E	Reeded Round	36"	3-3/4"	8"	6-3/4"
	ISL8500E	Reeded Round	36"	5"	8"	6-3/4"
	BAR8300F	Fluted Round	42"	3"	8"	6-3/4"
	BAR8375F	Fluted Round	42"	3-3/4"	8"	6-3/4"
Plain	BAR8500F	Fluted Round	42"	5"	8"	6-3/4"
	ISL8300F	Fluted Round	36"	3"	8"	6-3/4"
	ISL8375F	Fluted Round	36"	3-3/4"	8"	6-3/4"
	ISL8500F	Fluted Round	36"	5"	8"	6-3/4"
	BAR8300P	Plain Round	42"	3"	8"	6-3/4"
Roped	BAR8375P	Plain Round	42"	3-3/4"	8"	6-3/4"
	BAR8500P	Plain Round	42"	5"	8"	6-3/4"
	ISL8300P	Plain Round	36"	3"	8"	6-3/4"
	ISL8350P	Plain Round	36"	3-1/2"	8"	6-3/4"
	ISL8375P	Plain Round	36"	3-3/4"	8"	6-3/4"
Roped	ISL8500P	Plain Round	36"	5"	8"	6-3/4"
	BAR8300R	Roped Round	42"	3"	8"	6-3/4"
	BAR8375R	Roped Round	42"	3-3/4"	8"	6-3/4"
	BAR8500R	Roped Round	42"	5"	8"	6-3/4"
	ISL8300R	Roped Round	36"	3"	8"	6-3/4"
Roped	ISL8350R	Roped Round	36"	3-1/2"	8"	6-3/4"
	ISL8375R	Roped Round	36"	3-3/4"	8"	6-3/4"
	ISL8500R	Roped Round	36"	5"	8"	6-3/4"



Athena CBL-001-L



Athena CBL-001-M



Athena CBL-001-S

Available in Alder, Cherry, Maple, Poplar & Red Oak

Item No.	Tall	Deep	Wide
CBL-001-S	6-3/4"	3-3/4"	3-1/2"
CBL-001-M	10"	5"	5"
CBL-001-L	14"	7"	5-1/4"



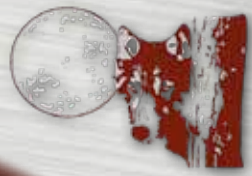

MADISON FAMILY

Family Suites



Traditional
CBL-PT4

Item No.	Tall	Deep	Wide
CBL-PT4	13"	7-3/4"	3-3/8"

Available in Alder, Cherry, Maple, Red Oak & Rubberwood

CBL-WC12F
Fluted

CBL-WC12-5.75

CBL-WC12-4.5

CBL-WC12

Traditional

Item No.	Description	Tall	Deep	Wide
CBL-WC12	Plain	12"	6-1/2"	3"
CBL-WC12-4.5	Plain	12"	6-1/2"	4-1/2"
CBL-WC12-5.75	Plain	12"	6-1/2"	5-3/4"
CBL-WC12F	Fluted	12"	6-1/2"	3"

Available in Alder, Cherry, Maple, Red Oak & Rubberwood

Traditional
CBL-PT5

Item No.	Tall	Deep	Wide
CBL-PT5	4-1/4"	1-3/4"	2-7/8"

Available in Alder, Cherry, Maple, Red Oak & Rubberwood



Flute
Detail

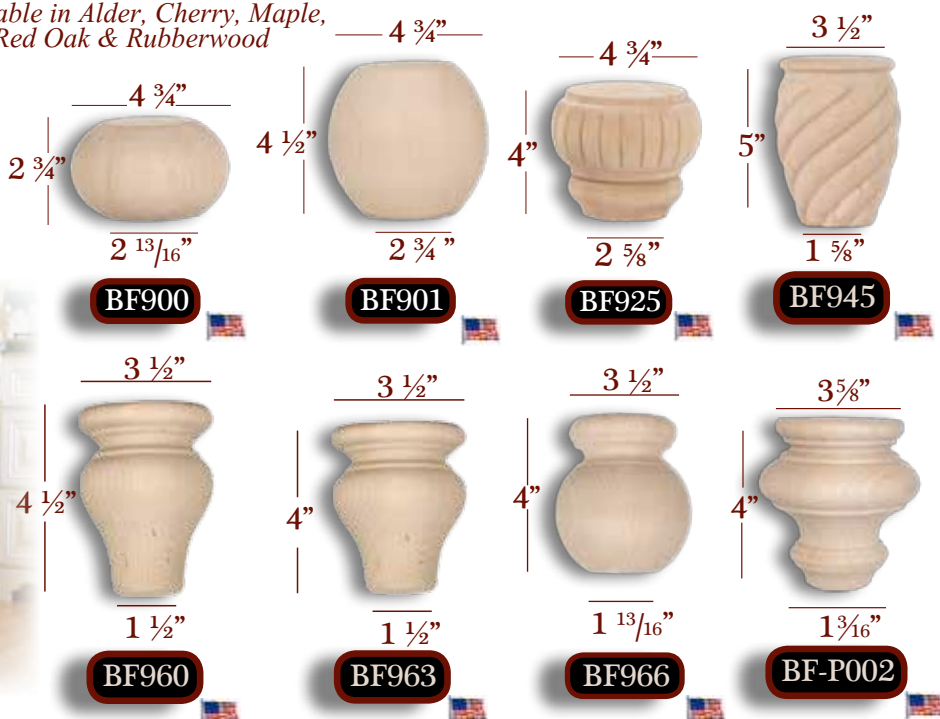

ISL8375R
Shown in Picture



ISL8350E
Shown in Picture

Item No.	Description	Tall	Overall Width	Toe
BF900	Plain	2-3/4"	4-3/4"	2-13/16"
BF901	Plain	4-1/2"	4-3/4"	2-3/4"
BF925	Reeded	4"	4-3/4"	2-5/8"
BF945	Roped	5"	3-1/2"	1-5/8"
BF960	Plain	4-1/2"	3-1/2"	1-1/2"
BF963	Plain	4"	3-1/2"	1-1/2"
BF966	Plain	4"	3-1/2"	1-13/16"
BF-P002	Plain	4"	3-5/8"	1-3/16"

Available in Alder, Cherry, Maple, Pine, Poplar, Red Oak & Rubberwood
Other Species upon request

"Leading the Pack"

MISSION FAMILY

Family Suites

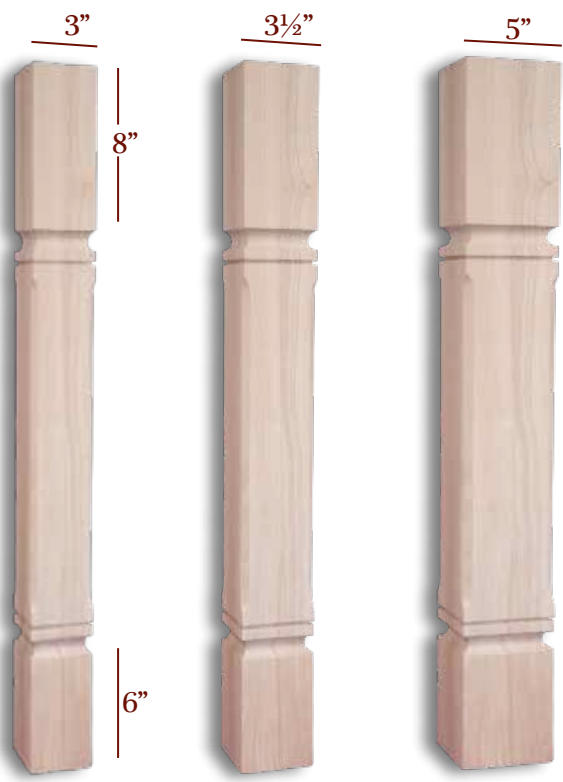

ISL22300-CC

ISL22350-CC

ISL22500-CC

Posts also available in: 42"

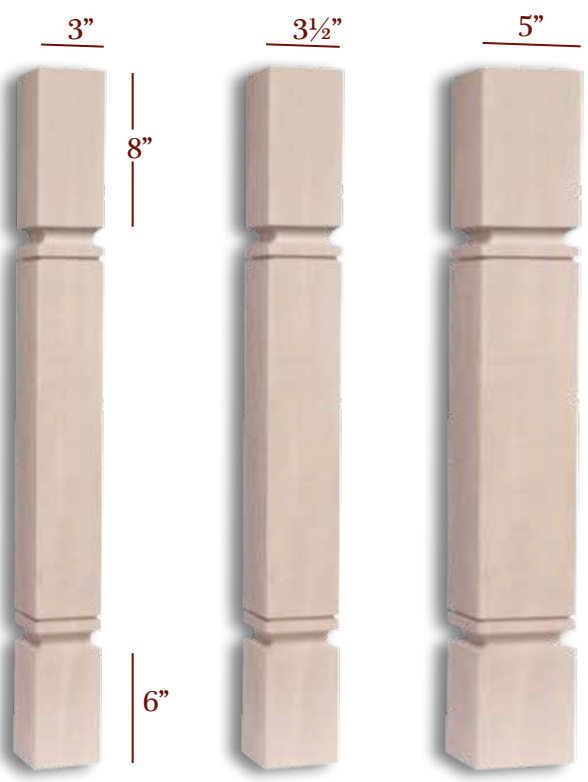

ISL22300-CP

ISL22350-CP

ISL22500-CP

Posts also available in: 42"

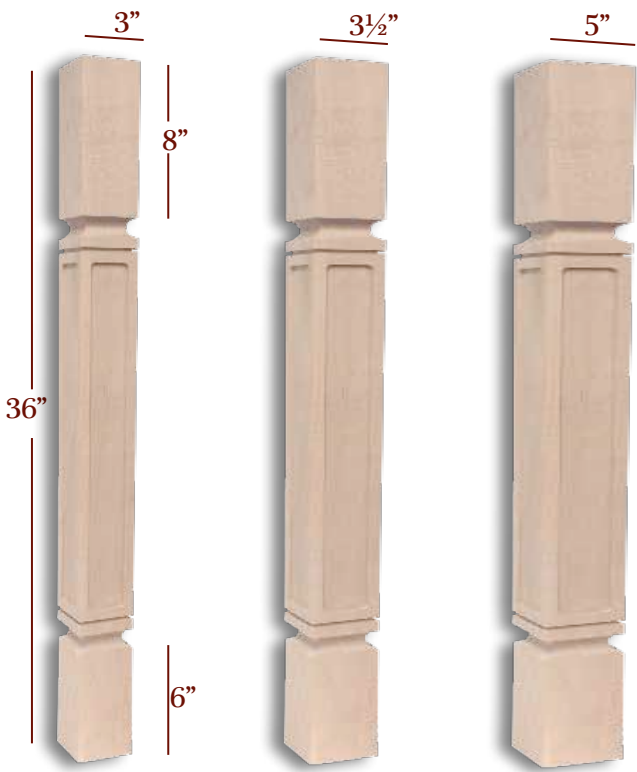

ISL22300-FW

ISL22350-FW

ISL22500-FW

Posts also available in: 42"

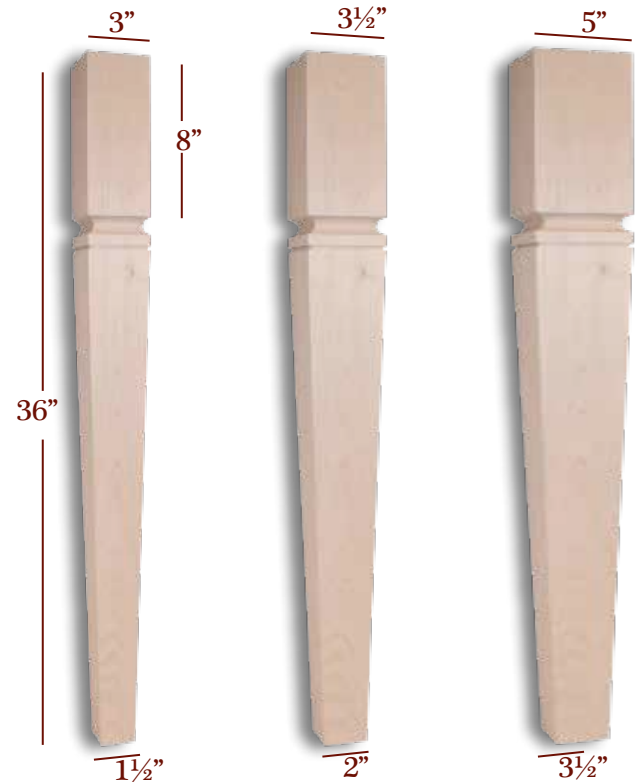

ISL22300-TP

ISL22350-TP

ISL22500-TP

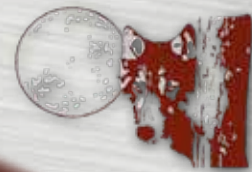

MISSION FAMILY



	Item No.	Tall	Overall Width	Top Shank Length	Bottom Shank Length	Toe
Chamfered Corners	BAR22300-CC	42"	3"	8"	6"	N/A
	BAR22350-CC	42"	3-1/2"	8"	6"	N/A
	BAR22500-CC	42"	5"	8"	6"	N/A
	ISL22300-CC	36"	3"	8"	6"	N/A
	ISL22350-CC	36"	3-1/2"	8"	6"	N/A
Plain	ISL22500-CC	36"	5"	8"	6"	N/A
	BAR22300-CP	42"	3"	8"	6"	N/A
	BAR22350-CP	42"	3-1/2"	8"	6"	N/A
	BAR22500-CP	42"	5"	8"	6"	N/A
	ISL22300-CP	36"	3"	8"	6"	N/A
Full Window	ISL22350-CP	36"	3-1/2"	8"	6"	N/A
	ISL22500-CP	36"	5"	8"	6"	N/A
	BAR22300-FW	42"	3"	8"	6"	N/A
	BAR22350-FW	42"	3-1/2"	8"	6"	N/A
	BAR22500-FW	42"	5"	8"	6"	N/A
Outline Window	ISL22300-FW	36"	3"	8"	6"	N/A
	ISL22350-FW	36"	3-1/2"	8"	6"	N/A
	ISL22500-FW	36"	5"	8"	6"	N/A
	BAR22300-OW	42"	3"	8"	6"	N/A
	BAR22350-OW	42"	3-1/2"	8"	6"	N/A
Taper	BAR22500-OW	42"	5"	8"	6"	N/A
	ISL22300-OW	36"	3"	8"	6"	N/A
	ISL22350-OW	36"	3-1/2"	8"	6"	N/A
Bun Feet	ISL22500-OW	36"	5"	8"	6"	N/A
	ISL22300-TP	36"	3"	8"	N/A	1-1/2"
	ISL22350-TP	36"	3-1/2"	8"	N/A	2"
Bun Feet	ISL22500-TP	36"	5"	8"	N/A	3-1/2"
	BF965-C	4"	3-1/2"	N/A	N/A	2-1/2"
	BFS22S	4"	2-1/2"	N/A	N/A	1-1/2"
BFS22L	4"	3-3/4"	N/A	N/A	2-5/8"	



BF965-C



BFS22S



BFS22L

Family Suites

Posts & Bun Feet available in Alder, Cherry, Maple, Poplar, Red Oak & Rubberwood Other Species upon request

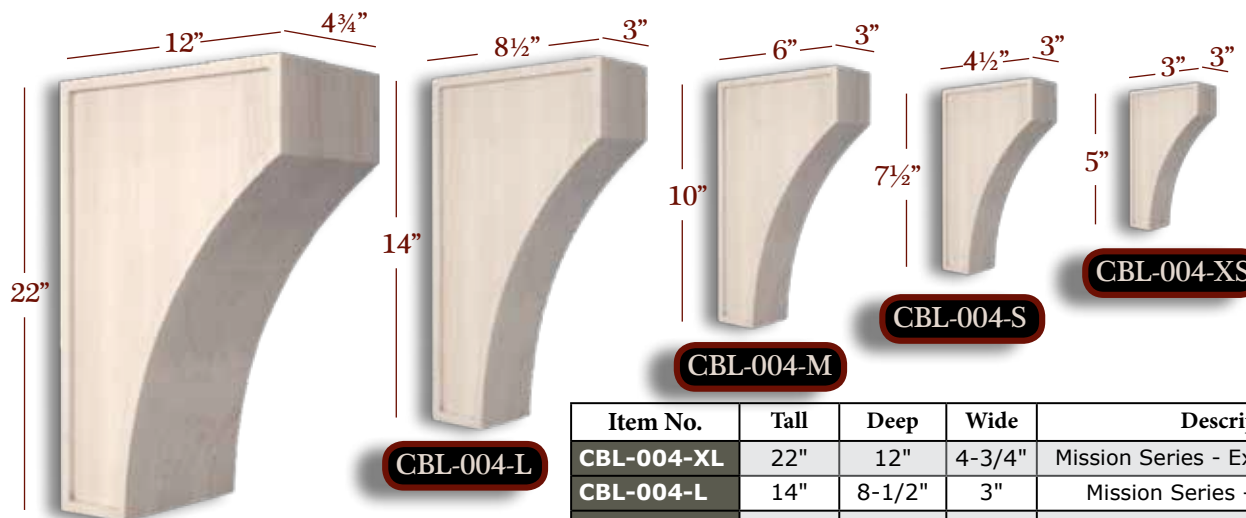

Corbels available in Alder, Cherry, Maple, Poplar, Red Oak & Rubberwood Other Species upon request

For more Mission ideas see Pages 8, 83, 98, 104 & 105

Item No.	Tall	Deep	Wide	Description
CBL-004-XL	22"	12"	4-3/4"	Mission Series - Extra Large Corbel
CBL-004-L	14"	8-1/2"	3"	Mission Series - Large Corbel
CBL-004-M	10"	6"	3"	Mission Series - Medium Corbel
CBL-004-S	7-1/2"	4-1/2"	3"	Mission Series - Small Corbel
CBL-004-XS	5"	3"	3"	Mission Series - Extra Small Corbel

"Leading the Pack"

MONACO FAMILY

Plain Square

Family Suites



ISL21375CP & ISL21500CP
Shown in Picture

Item No.	Description	Tall	Overall Width	Top Shank Length	Toe
ISL21350CP	Plain Square	36"	3-1/2"	13"	1-1/4"
ISL21475CP	Plain Square	36"	4-3/4"	13"	2-3/8"
BF803	Plain Square	2-3/4"	3-1/2"	N/A	2-1/2"
BF805	Plain Square	4-1/2"	3-1/4"	N/A	2-1/2"
BF914-C	Plain Square	9-1/8"	3-1/2"	N/A	1"
BF918-C	Plain Square	2-1/8"	4-1/2"	N/A	3-5/16"
BF920-C	Plain Square	4"	3-1/2"	N/A	2-1/4"
BF958-C	Plain Square	4-1/2"	3-1/2"	N/A	1-3/4"
BF959-C	Plain Square	4-1/2"	4-5/8"	N/A	3"
BF961-C	Plain Square	4"	3-1/2"	N/A	1-3/4"
BF962-C	Plain Square	4"	4-5/8"	N/A	3"

Available in Alder, Cherry, Maple, Poplar, Red Oak & Rubberwood
Other Species upon request

American Made

Phone: 877-504-WOLF
(9653)
sales@TimberWolfForest.com

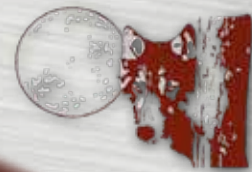

MONACO FAMILY

Family Suites



CBL-VM430



CBL-VM429



CBL-VM428



CBL-VM427



CBL-VM426

Item No.	Tall	Deep	Wide
CBL-VM430	36"	8"	8"
CBL-VM429	26-1/2"	7"	7"
CBL-VM428	18-1/2"	5-3/4"	5-3/4"
CBL-VM427	14"	5"	5"
CBL-VM426	10-1/2"	4"	4"

Available in Alder, Aspen, Cherry, Maple & Oak

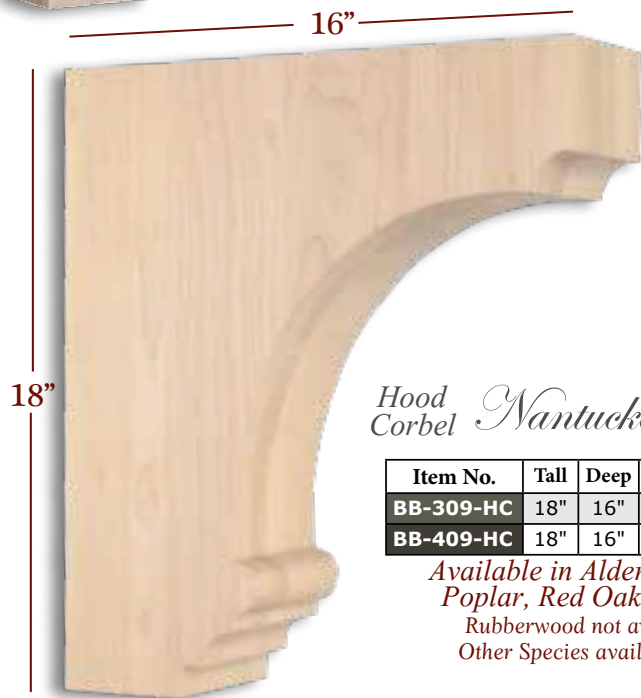

Hood Corbel *Nantucket*

Item No.	Tall	Deep	Wide	Description
BB-309-HC	18"	16"	3"	Hood Corbel
BB-409-HC	18"	16"	4-3/4"	Hood Corbel

Available in Alder, Cherry, Maple, Poplar, Red Oak & Rubberwood

Rubberwood not available in 4-3/4"
Other Species available upon request



Overhang Bracket *Nantucket*

Item No.	Tall	Deep	Wide	Description
BB-009-OH	10"	10"	1-3/4"	Overhang
BB-309-OH	10"	10"	3"	Overhang
BB-409-OH	10"	10"	4-3/4"	Overhang

Available in Alder, Cherry, Maple, Poplar, Red Oak & Rubberwood
Rubberwood not available in 4-3/4"
Other Species available upon request



Large Medium Small Extra Small

Available in Alder, Cherry, Maple, Poplar, Red Oak & Rubberwood
Rubberwood not available in 4-3/4"
Other Species available upon request

Bar Brackets *Nantucket*

	Item No.	Tall	Deep	Wide	Description
1-3/4" W	BB-009-L	12"	8"	1-3/4"	Large
	BB-009-M	9"	6-1/2"	1-3/4"	Medium
	BB-009-S	7-1/2"	5"	1-3/4"	Small
	BB-009-XS	6"	4"	1-3/4"	Extra Small
3" W	BB-309-L	12"	8"	3"	Large
	BB-309-M	9"	6-1/2"	3"	Medium
	BB-309-S	7-1/2"	5"	3"	Small
	BB-309-XS	6"	4"	3"	Extra Small
4-3/4" W	BB-409-L	12"	8"	4-3/4"	Large
	BB-409-M	9"	6-1/2"	4-3/4"	Medium
	BB-409-S	7-1/2"	5"	4-3/4"	Small
	BB-409-XS	6"	4"	4-3/4"	Extra Small



"Leading the Pack"

MONTE CRISTO FAMILY

Family Suites

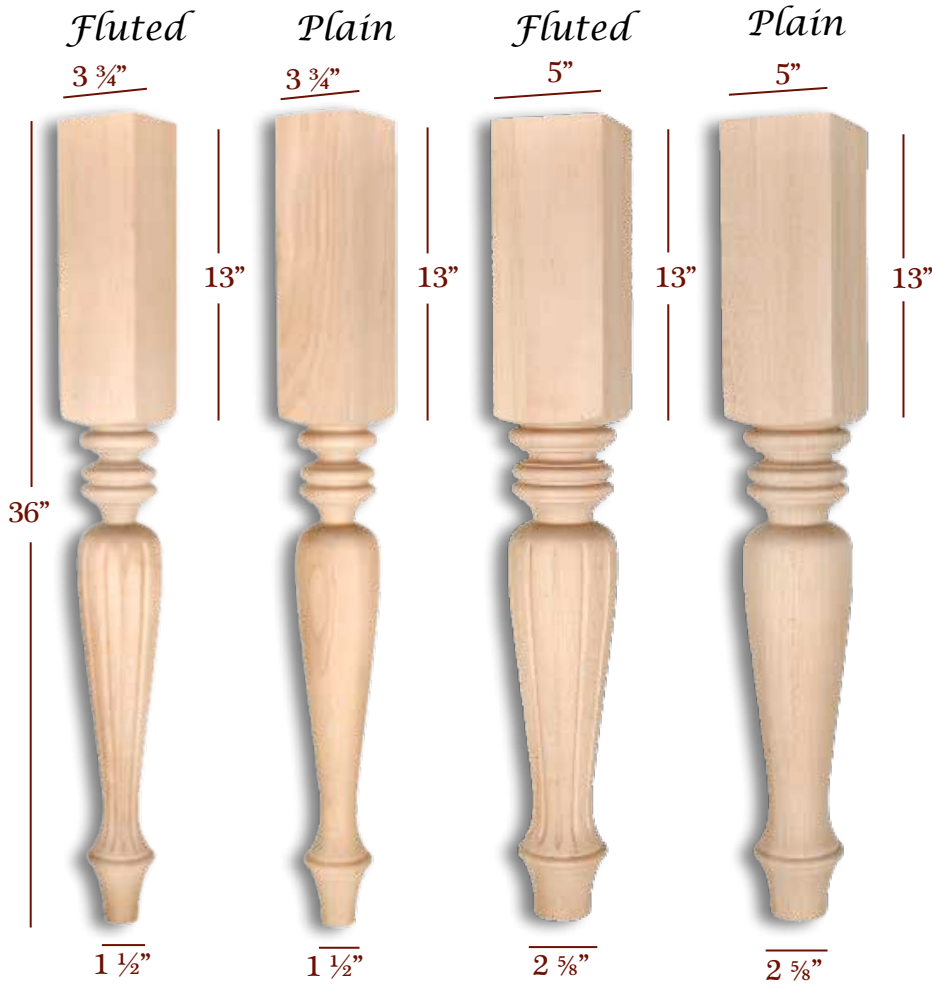

ISL11375F **ISL11375P**

ISL11500F **ISL11500P**

Monte Cristo Series Legs are also available in 18", 21" & 29" See Page 176 & 177

Legs available in Alder, Cherry, Maple, Poplar, Red Oak & Rubberwood Other Species upon request

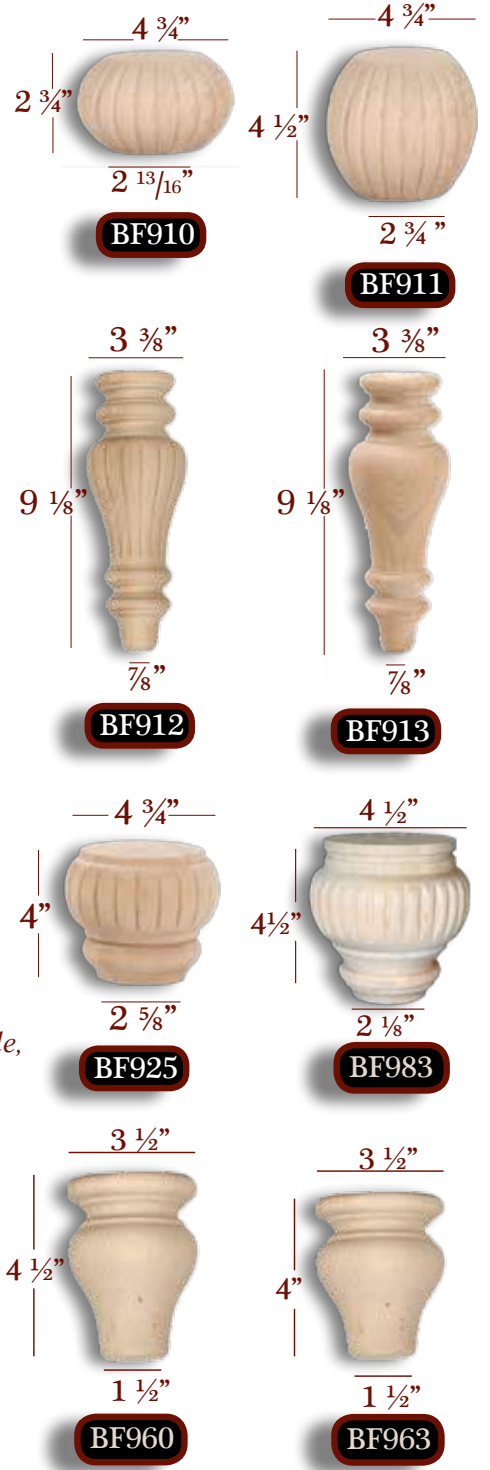

BF910

BF911

BF912

BF913

BF925

BF983

BF960

BF963

Item No.	Description	Tall	Overall Width	Top Shank Length	Toe
ISL11375F	Fluted	36"	3-3/4"	13"	1-1/2"
ISL11375P	Plain	36"	3-3/4"	13"	1-1/2"
ISL11500F	Fluted	36"	5"	13"	2-5/8"
ISL11500P	Plain	36"	5"	13"	2-5/8"
BF910	Reeded	2-3/4"	4-3/4"	N/A	2-13/16"
BF911	Reeded	4-1/2"	4-3/4"	N/A	2-3/4"
BF912	Reeded	9-1/8"	3-3/8"	N/A	7/8"
BF913	Plain	9-1/8"	3-3/8"	N/A	7/8"
BF925	Reeded	4"	4-3/4"	N/A	2-5/8"
BF960	Plain	4-1/2"	3-1/2"	N/A	1-1/2"
BF963	Plain	4"	3-1/2"	N/A	1-1/2"
BF983	Reeded	4-1/2"	4-1/2"	N/A	2-1/8"

Bun Feet available in Alder, Cherry, Maple, Pine, Poplar, Red Oak & Rubberwood Other Species upon request

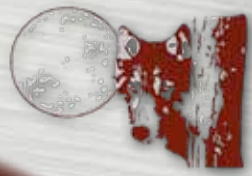

MONTE CRISTO FAMILY

Family Suites

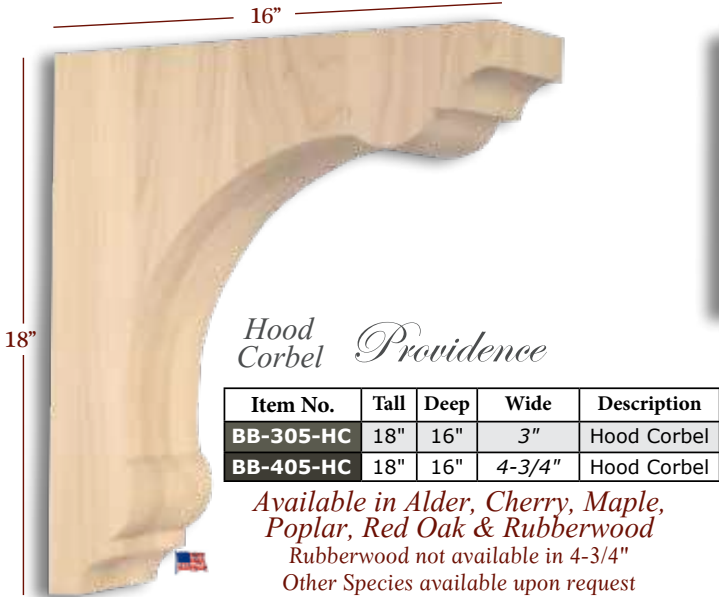

Hood Corbel *Providence*

Item No.	Tall	Deep	Wide	Description
BB-305-HC	18"	16"	3"	Hood Corbel
BB-405-HC	18"	16"	4-3/4"	Hood Corbel

Available in Alder, Cherry, Maple, Poplar, Red Oak & Rubberwood
 Rubberwood not available in 4-3/4"
 Other Species available upon request



Bar Brackets *Providence*

	Item No.	Tall	Deep	Wide	Description
1-3/4" W	BB-005-L	12-1/2"	6-1/2"	1-3/4"	Large
	BB-005-M	9-9/16"	5"	1-3/4"	Medium
	BB-005-S	7-3/4"	4"	1-3/4"	Small
	BB-005-XS	6-5/16"	3-1/4"	1-3/4"	Extra Small
3" W	BB-305-L	12-1/2"	6-1/2"	3"	Large
	BB-305-M	9-9/16"	5"	3"	Medium
	BB-305-S	7-3/4"	4"	3"	Small
	BB-305-XS	6-5/16"	3-1/4"	3"	Extra Small
4-3/4" W	BB-405-L	12-1/2"	6-1/2"	4-3/4"	Large
	BB-405-M	9-9/16"	5"	4-3/4"	Medium
	BB-405-S	7-3/4"	4"	4-3/4"	Small
	BB-405-XS	6-5/16"	3-1/4"	4-3/4"	Extra Small

Available in Alder, Cherry, Maple, Poplar, Red Oak & Rubberwood
 Rubberwood not available in 4-3/4"
 Other Species available upon request

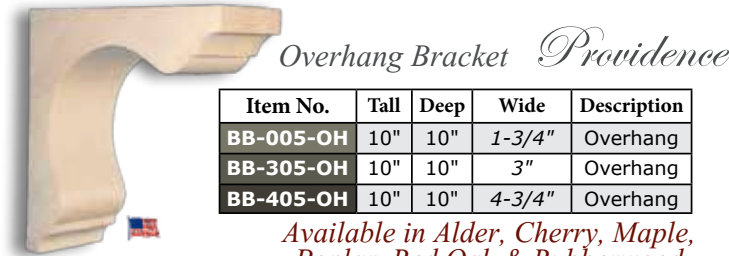

Overhang Bracket *Providence*

Item No.	Tall	Deep	Wide	Description
BB-005-OH	10"	10"	1-3/4"	Overhang
BB-305-OH	10"	10"	3"	Overhang
BB-405-OH	10"	10"	4-3/4"	Overhang

Available in Alder, Cherry, Maple, Poplar, Red Oak & Rubberwood
 Rubberwood not available in 4-3/4"
 Other Species available upon request



CBL-PT3



CBL-PT2



CBL-PT1



CBL-PT4



CBL-PT5

Traditional

Item No.	Tall	Deep	Wide	Description	Species
CBL-PT1	10"	5-1/4"	4-1/2"	Corbel - Small Trad. Corbel	These Items are available in Alder, Cherry, Maple, Red Oak, & Rubberwood
CBL-PT2	14"	7"	5"	Corbel - Medium Trad. Corbel	
CBL-PT3	22"	7-5/8"	6-3/4"	Corbel - Large Trad. Corbel	
CBL-PT4	13"	7-3/4"	3-3/8"	Corbel - Traditional Bar Bracket	
CBL-PT5	4-1/4"	1-3/4"	2-7/8"	Corbel - Mini Traditional	

"Leading the Pack"

ROCHESTER FAMILY

Family Suites

Plain
5"



ISL32500P



BF913



BF919



BF-P002



BF960



BF963



BF975

Bun Feet available in Alder, Cherry, Maple, Pine, Poplar, Red Oak & Rubberwood
Other Species upon request

Legs available in Alder, Cherry, Maple, Poplar, Red Oak & Rubberwood
Other Species upon request

Item No.	Description	Tall	Overall Width	Top Shank Length	Bottom Shank Length	Toe
ISL32500P	Plain	36"	5"	7-5/8"	6"	N/A
BF913	Plain	9-1/8"	3-3/8"	N/A	N/A	7/8"
BF919	Plain	4"	3-1/2"	N/A	N/A	2-1/4"
BF960	Plain	4-1/2"	3-1/2"	N/A	N/A	1-1/2"
BF963	Plain	4"	3-1/2"	N/A	N/A	1-1/2"
BF975	Plain	3"	4-3/4"	N/A	N/A	3-13/16"
BF-P002	Plain	4"	3-5/8"	N/A	N/A	1-3/16"

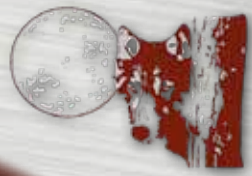

ROCHESTER FAMILY

Family Suites

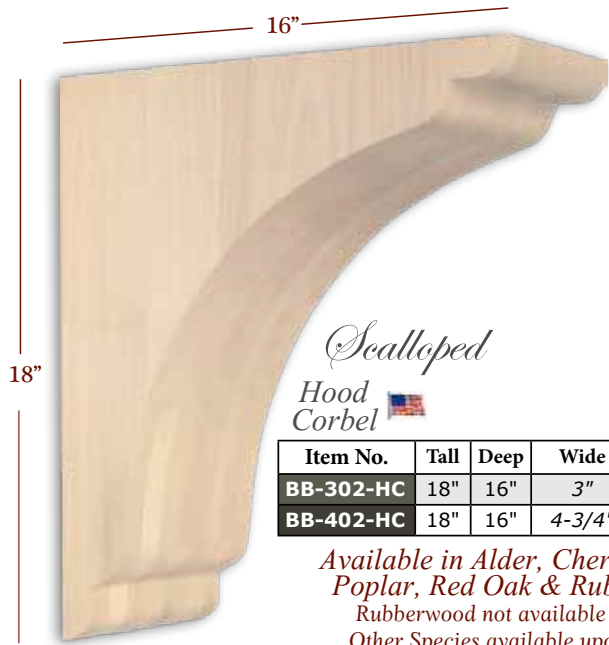

Scalloped
Hood Corbel

Item No.	Tall	Deep	Wide	Description
BB-302-HC	18"	16"	3"	Hood Corbel
BB-402-HC	18"	16"	4-3/4"	Hood Corbel

Available in Alder, Cherry, Maple, Poplar, Red Oak & Rubberwood
Rubberwood not available in 4-3/4"
Other Species available upon request

Scalloped
Bar Brackets

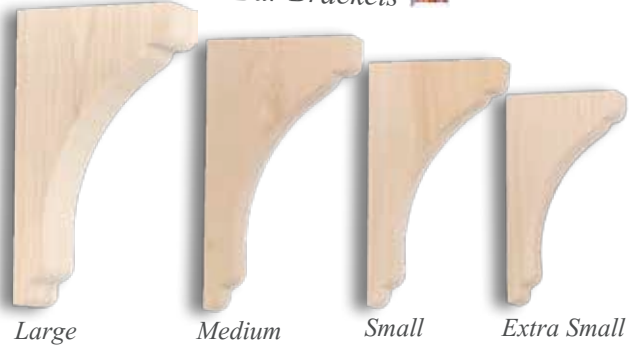

	Item No.	Tall	Deep	Wide	Description
1-3/4" W	BB-002-L	14-5/32"	8"	1-3/4"	Large
	BB-002-M	10-5/8"	5-1/2"	1-3/4"	Medium
	BB-002-S	9"	5"	1-3/4"	Small
	BB-002-XS	7-3/16"	4"	1-3/4"	Extra Small
3" W	BB-302-L	14-5/32"	8"	3"	Large
	BB-302-M	10-5/8"	5-1/2"	3"	Medium
	BB-302-S	9"	5"	3"	Small
	BB-302-XS	7-3/16"	4"	3"	Extra Small
4-3/4" W	BB-402-L	14-5/32"	8"	4-3/4"	Large
	BB-402-M	10-5/8"	5-1/2"	4-3/4"	Medium
	BB-402-S	9"	5"	4-3/4"	Small
	BB-402-XS	7-3/16"	4"	4-3/4"	Extra Small

Available in Alder, Cherry, Maple, Poplar, Red Oak & Rubberwood
Rubberwood not available in 4-3/4"
Other Species available upon request



Scalloped
Overhang Bracket

Item No.	Tall	Deep	Wide	Description
BB-002-OH	10"	10"	1-3/4"	Overhang
BB-302-OH	10"	10"	3"	Overhang
BB-402-OH	10"	10"	4-3/4"	Overhang

Available in Alder, Cherry, Maple, Poplar, Red Oak & Rubberwood
Rubberwood not available in 4-3/4"
Other Species available upon request



Athena
CBL-001-L



Athena
CBL-001-M



Athena
CBL-001-S

Item No.	Tall	Deep	Wide
CBL-001-S	6-3/4"	3-3/4"	3-1/2"
CBL-001-M	10"	5"	5"
CBL-001-L	14"	7"	5-1/4"

Available in Alder, Cherry, Maple, Poplar & Red Oak



Traditional
CBL-PT5

Item No.	Tall	Deep	Wide
CBL-PT5	4-1/4"	1-3/4"	2-7/8"

Available in Alder, Cherry, Maple, Red Oak & Rubberwood



Traditional
CBL-PT4

Item No.	Tall	Deep	Wide
CBL-PT4	13"	7-3/4"	3-3/8"

Available in Alder, Cherry, Maple, Red Oak & Rubberwood

"Leading the Pack"

ROOSEVELT FAMILY

Plain

Family Suites



ISL36350P



ISL36500P

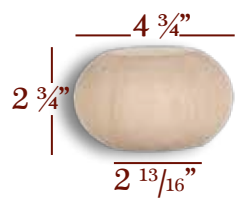

BF900

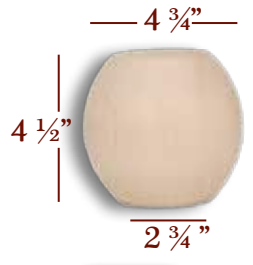

BF901



BF913



BF966

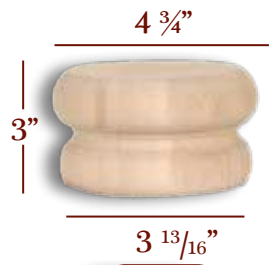

BF975

Bun Feet available in Alder, Cherry, Maple, Pine, Poplar, Red Oak & Rubberwood
Other Species upon request

Item No.	Description	Tall	Overall Width	Top Shank Length	Toe
ISL36350P	Plain	36"	3-1/2"	9-1/2"	2"
ISL36500P	Plain	36"	5"	9-1/2"	3-1/2"
BF900	Plain	2-3/4"	4-3/4"	N/A	2-13/16"
BF901	Plain	4-1/2"	4-3/4"	N/A	2-3/4"
BF913	Plain	9-1/8"	3-3/8"	N/A	7/8"
BF966	Plain	4"	3-1/2"	N/A	1-13/16"
BF975	Plain	3"	4-3/4"	N/A	3-13/16"

Legs available in Alder, Cherry, Maple, Poplar, Red Oak & Rubberwood
Other Species upon request

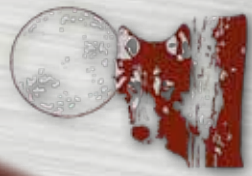

ROOSEVELT FAMILY

Family Suites



Rockefeller
Massive
Hood Corbel

Item No.	Tall	Deep	Wide	Description
BB-611-MHC	26"	19"	6"	Massive Hood Corbel

Available in Alder, Cherry, Maple, Poplar, Red Oak & Rubberwood
Rubberwood not available in 4-3/4"
Other Species available upon request

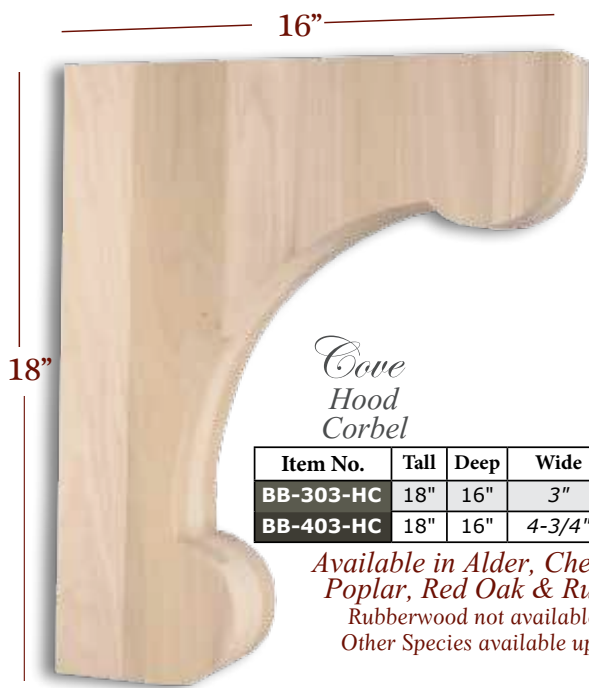

Cove
Hood
Corbel

Item No.	Tall	Deep	Wide	Description
BB-303-HC	18"	16"	3"	Hood Corbel
BB-403-HC	18"	16"	4-3/4"	Hood Corbel

Available in Alder, Cherry, Maple, Poplar, Red Oak & Rubberwood
Rubberwood not available in 4-3/4"
Other Species available upon request



Cove
Overhang
Bracket

Item No.	Tall	Deep	Wide	Description
BB-003-OH	9-3/4"	9-3/4"	1-3/4"	Overhang
BB-303-OH	9-3/4"	9-3/4"	3"	Overhang
BB-403-OH	9-3/4"	9-3/4"	4-3/4"	Overhang

Available in Alder, Cherry, Maple, Poplar, Red Oak & Rubberwood
Rubberwood not available in 4-3/4"
Other Species available upon request



Large Medium Small Extra Small

	Item No.	Tall	Deep	Wide	Description
1-3/4" W	BB-003-L	12-5/8"	8"	1-3/4"	Large
	BB-003-M	9-1/2"	4-7/8"	1-3/4"	Medium
	BB-003-S	8"	5"	1-3/4"	Small
	BB-003-XS	6-3/8"	4"	1-3/4"	Extra Small
3" W	BB-303-L	12-5/8"	8"	3"	Large
	BB-303-M	9-1/2"	4-7/8"	3"	Medium
	BB-303-S	8"	5"	3"	Small
	BB-303-XS	6-3/8"	4"	3"	Extra Small
4-3/4" W	BB-403-L	12-5/8"	8"	4-3/4"	Large
	BB-403-M	9-1/2"	4-7/8"	4-3/4"	Medium
	BB-403-S	8"	5"	4-3/4"	Small
	BB-403-XS	6-3/8"	4"	4-3/4"	Extra Small

"Leading the Pack"

SALEM FAMILY

Family Suites

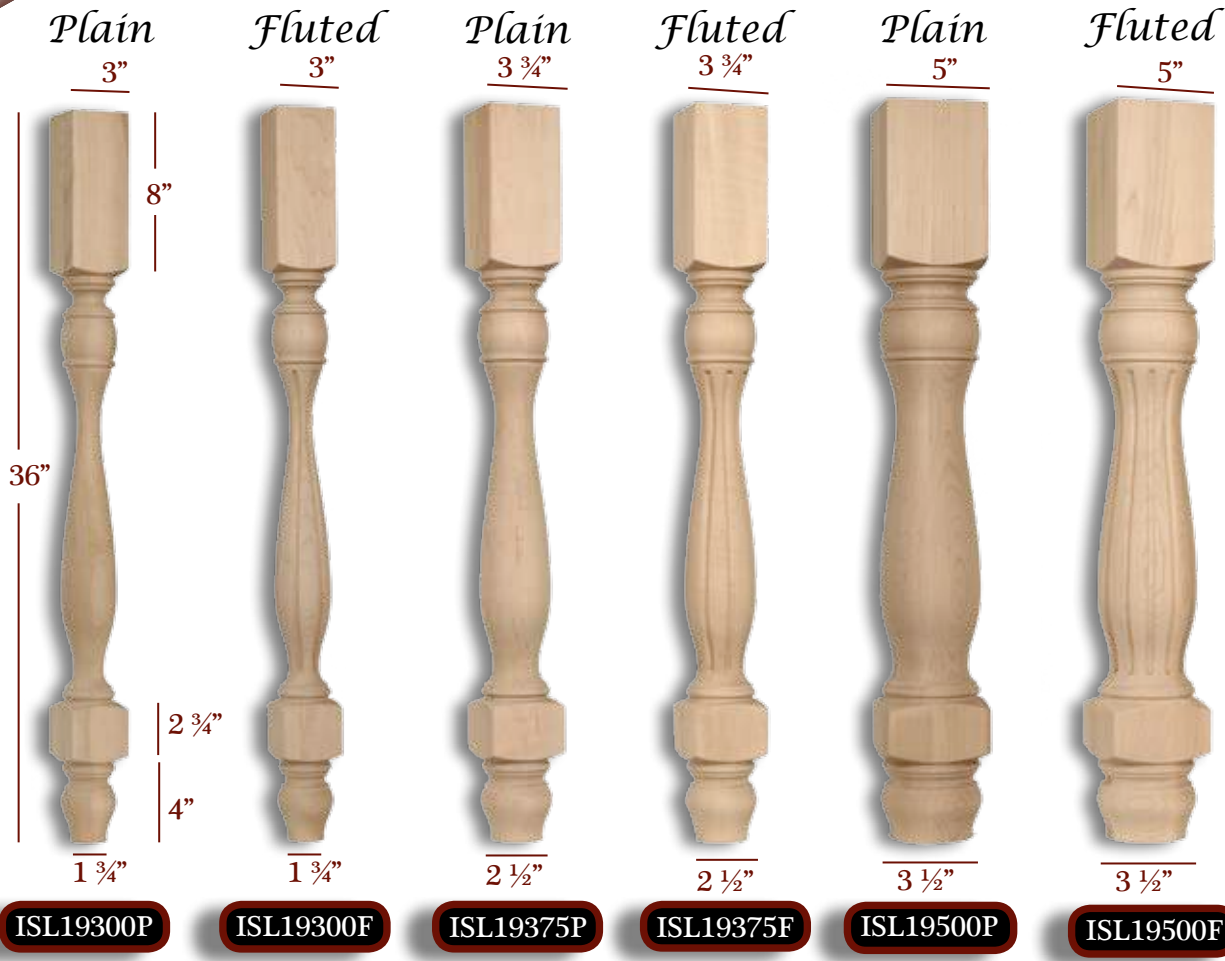

 Salem Series is also available in 29" & 42" See Page 134 & 178

Available in Alder, Cherry, Maple, Poplar, Red Oak & Rubberwood
Other Species upon request

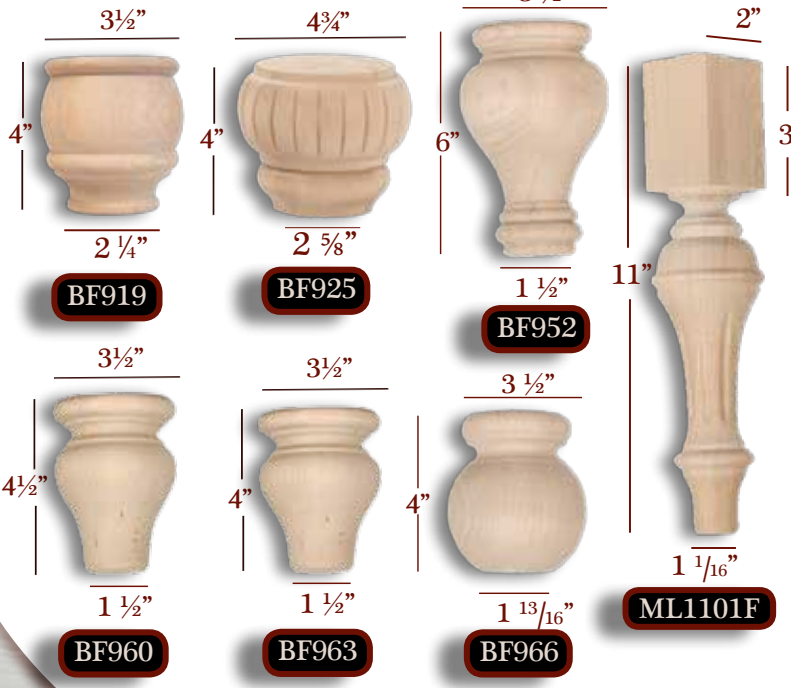

Item No.	Desc.	Tall	Overall Width	Top Shank Length	Block	Toe
BAR19300F	Fluted	42"	3"	12"	2-3/4"	1-3/4"
BAR19300P	Plain	42"	3"	12"	2-3/4"	1-3/4"
BAR19350F	Fluted	42"	3-1/2"	12"	2-3/4"	2-1/4"
BAR19350P	Plain	42"	3-1/2"	12"	2-3/4"	2-1/4"
BAR19375F	Fluted	42"	3-3/4"	12"	2-3/4"	2-1/2"
BAR19375P	Plain	42"	3-3/4"	12"	2-3/4"	2-1/2"
BAR19500F	Fluted	42"	5"	12"	2-3/4"	3-1/2"
BAR19500P	Plain	42"	5"	12"	2-3/4"	3-1/2"
ISL19300F	Fluted	36"	3"	8"	2-3/4"	1-3/4"
ISL19300P	Plain	36"	3"	8"	2-3/4"	1-3/4"
ISL19350F	Fluted	36"	3-1/2"	8"	2-3/4"	2-1/4"
ISL19350P	Plain	36"	3-1/2"	8"	2-3/4"	2-1/4"
ISL19375F	Fluted	36"	3-3/4"	8"	2-3/4"	2-1/2"
ISL19375P	Plain	36"	3-3/4"	8"	2-3/4"	2-1/2"
ISL19500F	Fluted	36"	5"	8"	2-3/4"	3-1/2"
ISL19500P	Plain	36"	5"	8"	2-3/4"	3-1/2"
BF919	Plain	4"	3-1/2"	N/A	N/A	2-1/4"
BF925	Reeded	4"	4-3/4"	N/A	N/A	2-5/8"
BF952	Plain	6"	3-1/2"	N/A	N/A	1-1/2"
BF960	Plain	4-1/2"	3-1/2"	N/A	N/A	1-1/2"
BF963	Plain	4"	3-1/2"	N/A	N/A	1-1/2"
BF966	Plain	4"	3-1/2"	N/A	N/A	1-13/16"
ML1101F	Fluted	11"	2-5/8"	3"	N/A	1-1/16"

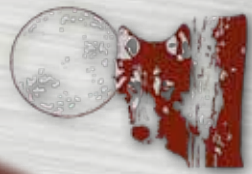

SALEM FAMILY

Family Suites

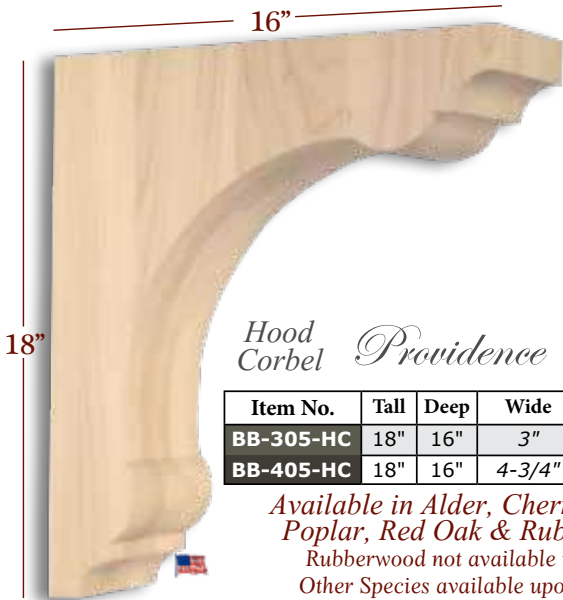

Hood Corbel *Providence*

Item No.	Tall	Deep	Wide	Description
BB-305-HC	18"	16"	3"	Hood Corbel
BB-405-HC	18"	16"	4-3/4"	Hood Corbel

Available in Alder, Cherry, Maple, Poplar, Red Oak & Rubberwood
 Rubberwood not available in 4-3/4"
 Other Species available upon request



Bar Brackets *Providence*

	Item No.	Tall	Deep	Wide	Description
1-3/4" W	BB-005-L	12-1/2"	6-1/2"	1-3/4"	Large
	BB-005-M	9-9/16"	5"	1-3/4"	Medium
	BB-005-S	7-3/4"	4"	1-3/4"	Small
	BB-005-XS	6-5/16"	3-1/4"	1-3/4"	Extra Small
3" W	BB-305-L	12-1/2"	6-1/2"	3"	Large
	BB-305-M	9-9/16"	5"	3"	Medium
	BB-305-S	7-3/4"	4"	3"	Small
	BB-305-XS	6-5/16"	3-1/4"	3"	Extra Small
4-3/4" W	BB-405-L	12-1/2"	6-1/2"	4-3/4"	Large
	BB-405-M	9-9/16"	5"	4-3/4"	Medium
	BB-405-S	7-3/4"	4"	4-3/4"	Small
	BB-405-XS	6-5/16"	3-1/4"	4-3/4"	Extra Small

Available in Alder, Cherry, Maple, Poplar, Red Oak & Rubberwood
 Rubberwood not available in 4-3/4"
 Other Species available upon request

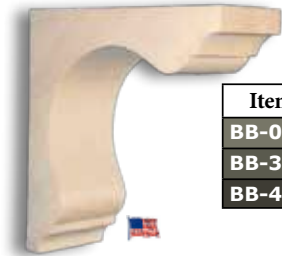

Overhang Bracket *Providence*

Item No.	Tall	Deep	Wide	Description
BB-005-OH	10"	10"	1-3/4"	Overhang
BB-305-OH	10"	10"	3"	Overhang
BB-405-OH	10"	10"	4-3/4"	Overhang

Available in Alder, Cherry, Maple, Poplar, Red Oak & Rubberwood
 Rubberwood not available in 4-3/4"
 Other Species available upon request



CBL-PT3



CBL-PT2



CBL-PT1



CBL-PT4



CBL-PT5

Traditional

Item No.	Tall	Deep	Wide	Description	Species
CBL-PT1	10"	5-1/4"	4-1/2"	Corbel - Small Trad. Corbel	These Items are available in Alder, Cherry, Maple, Red Oak, & Rubberwood
CBL-PT2	14"	7"	5"	Corbel - Medium Trad. Corbel	
CBL-PT3	22"	7-5/8"	6-3/4"	Corbel - Large Trad. Corbel	
CBL-PT4	13"	7-3/4"	3-3/8"	Corbel - Traditional Bar Bracket	
CBL-PT5	4-1/4"	1-3/4"	2-7/8"	Corbel - Mini Traditional	

"Leading the Pack"

SANTA FE FAMILY *

Family Suites



* Santa Fe Series is also available in 29" & 42" See Page 135 & 179

Legs available in Alder, Cherry, Maple, Poplar, Red Oak & Rubberwood
Other Species upon request

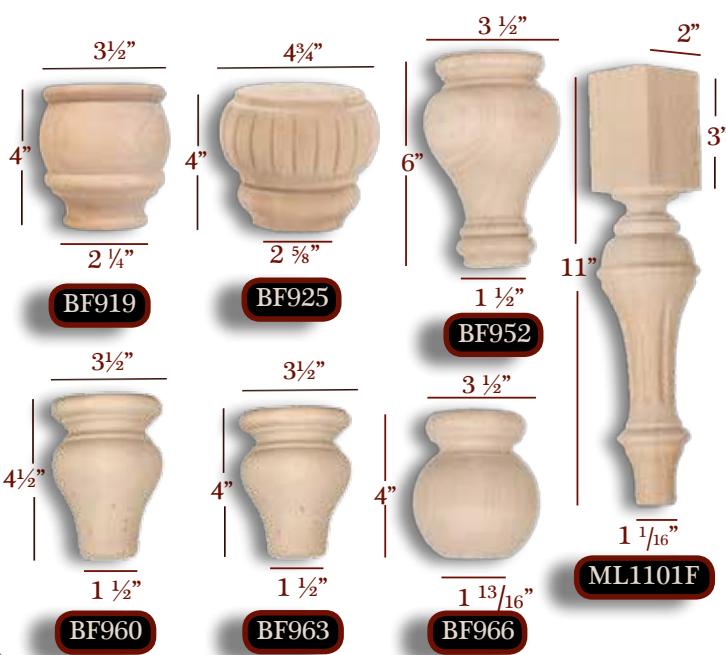

Item No.	Desc.	Tall	Overall Width	Top Shank Length	Bottom Shank Length	Toe
BAR20300F	Fluted	42"	3"	12"	6-3/4"	N/A
BAR20300P	Plain	42"	3"	12"	6-3/4"	N/A
BAR20375F	Fluted	42"	3-3/4"	12"	6-3/4"	N/A
BAR20375P	Plain	42"	3-3/4"	12"	6-3/4"	N/A
BAR20500F	Fluted	42"	5"	12"	6-3/4"	N/A
BAR20500P	Plain	42"	5"	12"	6-3/4"	N/A
ISL20300F	Fluted	36"	3"	8"	6-3/4"	N/A
ISL20300P	Plain	36"	3"	8"	6-3/4"	N/A
ISL20350F	Fluted	36"	3-1/2"	8"	6-3/4"	N/A
ISL20350P	Plain	36"	3-1/2"	8"	6-3/4"	N/A
ISL20375F	Fluted	36"	3-3/4"	8"	6-3/4"	N/A
ISL20375P	Plain	36"	3-3/4"	8"	6-3/4"	N/A
ISL20500F	Fluted	36"	5"	8"	6-3/4"	N/A
ISL20500P	Plain	36"	5"	8"	6-3/4"	N/A
BF919	Plain	4"	3-1/2"	N/A	N/A	2-1/4"
BF925	Reeded	4"	4-3/4"	N/A	N/A	2-5/8"
BF952	Plain	6"	3-1/2"	N/A	N/A	1-1/2"
BF960	Plain	4-1/2"	3-1/2"	N/A	N/A	1-1/2"
BF963	Plain	4"	3-1/2"	N/A	N/A	1-1/2"
BF966	Plain	4"	3-1/2"	N/A	N/A	1-13/16"
ML1101F	Fluted	11"	2-5/8"	3"	N/A	1-1/16"

Bun Feet available in Alder, Cherry, Maple, Pine, Poplar, Red Oak & Rubberwood
Other Species upon request

American Made

Phone: 877-504-WOLF
(9653)
sales@TimberWolfForest.com

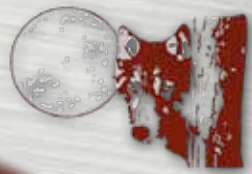

SANTA FE FAMILY

Family Suites



Athena
CBL-001-L



Athena
CBL-001-M



Athena
CBL-001-S

Item No.	Tall	Deep	Wide
CBL-001-S	6-3/4"	3-3/4"	3-1/2"
CBL-001-M	10"	5"	5"
CBL-001-L	14"	7"	5-1/4"

Available in Alder, Cherry, Maple, Poplar & Red Oak



Traditional
CBL-WC12-5.75



Traditional
CBL-WC12-4.5



Traditional
CBL-WC12

Item No.	Description	Tall	Deep	Wide
CBL-WC12	Plain	12"	6-1/2"	3"
CBL-WC12-4.5	Plain	12"	6-1/2"	4-1/2"
CBL-WC12-5.75	Plain	12"	6-1/2"	5-3/4"

Available in Alder, Cherry, Maple, Red Oak & Rubberwood



CBL-VT149



CBL-VT153



CBL-VT159



CBL-VT158



CBL-VT174



CBL-VT170

Traditional

Item No.	Tall	Deep	Wide
CBL-VT149	42"	9"	8-1/2"
CBL-VT153	36"	8"	7-1/2"
CBL-VT159	26-1/2"	7-1/2"	7"
CBL-VT158	18-1/2"	7"	5-7/8"
CBL-VT174	14"	5-3/4"	5"
CBL-VT170	10-1/2"	5"	3-7/8"

Also available in low profile See page 106 for details

Available in Alder, Aspen, Cherry, Maple & Oak

"Leading the Pack"

SAVANNAH FAMILY

Family Suites

Reeded

Plain

Reeded

Plain



ISL7375E

ISL7375P

ISL7500E

ISL7500P

*Legs available in Alder, Cherry, Maple, Poplar, Red Oak & Rubberwood
Other Species upon request*



BF900

BF910

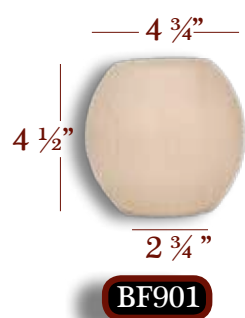

BF901

BF911



BF913

BF912



BF925

BF983

*Bun Feet available in Alder, Cherry, Maple, Pine, Poplar, Red Oak & Rubberwood
Other Species upon request*

Item No.	Description	Tall	Overall Width	Top Shank Length	Toe
ISL7375E	Reeded	36"	3-3/4"	12"	1-5/8"
ISL7375P	Plain	36"	3-3/4"	12"	1-5/8"
ISL7500E	Reeded	36"	5"	12"	2-3/4"
ISL7500P	Plain	36"	5"	12"	2-3/4"
BF900	Plain	2-3/4"	4-3/4"	N/A	2-13/16"
BF901	Plain	4-1/2"	4-3/4"	N/A	2-3/4"
BF910	Reeded	2-3/4"	4-3/4"	N/A	2-13/16"
BF911	Reeded	4-1/2"	4-3/4"	N/A	2-3/4"
BF912	Reeded	9-1/8"	3-3/8"	N/A	7/8"
BF913	Plain	9-1/8"	3-3/8"	N/A	7/8"
BF925	Reeded	4"	4-3/4"	N/A	2-5/8"
BF983	Reeded	4-1/2"	4-1/2"	N/A	2-1/8"

 Savannah Series Legs are also available in 29" See Page 180

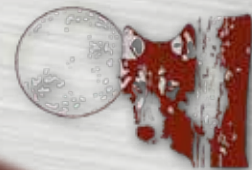

SAVANNAH FAMILY

16"

18"

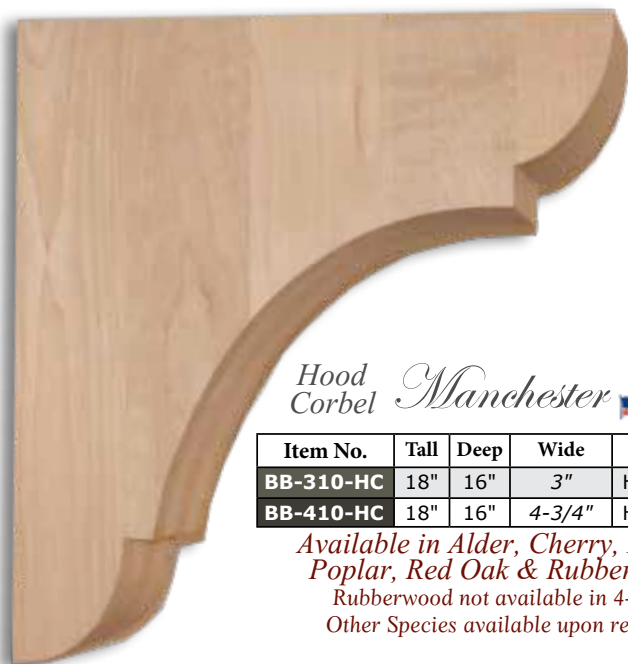

Hood Corbel *Manchester*

Item No.	Tall	Deep	Wide	Description
BB-310-HC	18"	16"	3"	Hood Corbel
BB-410-HC	18"	16"	4-3/4"	Hood Corbel

Available in Alder, Cherry, Maple, Poplar, Red Oak & Rubberwood
 Rubberwood not available in 4-3/4"
 Other Species available upon request

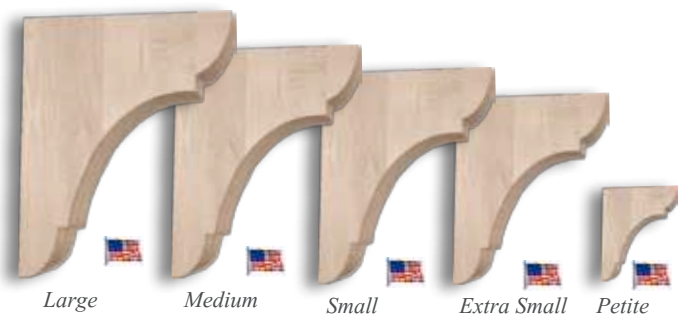

Large Medium Small Extra Small Petite

Bar Brackets *Manchester*

	Item No.	Tall	Deep	Wide	Description
1-3/4" W	BB-010-L	12"	8"	1-3/4"	Large
	BB-010-M	9"	6-1/2"	1-3/4"	Medium
	BB-010-S	7-1/2"	5"	1-3/4"	Small
	BB-010-XS	6"	4"	1-3/4"	Extra Small
	BB-010-P	3"	3"	1-3/4"	Petite
3" W	BB-310-L	12"	8"	3"	Large
	BB-310-M	9"	6-1/2"	3"	Medium
	BB-310-S	7-1/2"	5"	3"	Small
	BB-310-XS	6"	4"	3"	Extra Small
	BB-310-P	3"	3"	3"	Petite
4-3/4" W	BB-410-L	12"	8"	4-3/4"	Large
	BB-410-M	9"	6-1/2"	4-3/4"	Medium
	BB-410-S	7-1/2"	5"	4-3/4"	Small
	BB-410-XS	6"	4"	4-3/4"	Extra Small

Available in Alder, Cherry, Maple, Poplar, Red Oak & Rubberwood
 Rubberwood not available in 4-3/4"
 Other Species available upon request



Overhang Bracket *Manchester*

Item No.	Tall	Deep	Wide	Description
BB-010-OH	10"	10"	1-3/4"	Overhang
BB-310-OH	10"	10"	3"	Overhang
BB-410-OH	10"	10"	4-3/4"	Overhang

Available in Alder, Cherry, Maple, Poplar, Red Oak & Rubberwood
 Rubberwood not available in 4-3/4"
 Other Species available upon request



Mission
CBL-PM4

Item No.	Tall	Deep	Wide
CBL-PM4	12"	6-1/2"	2-1/2"

Available in Alder, Cherry, Maple, Red Oak & Rubberwood



Traditional

Fluted

Item No.	Description	Tall	Deep	Wide
CBL-WC12	Plain	12"	6-1/2"	3"
CBL-WC12-4.5	Plain	12"	6-1/2"	4-1/2"
CBL-WC12-5.75	Plain	12"	6-1/2"	5-3/4"
CBL-WC12F	Fluted	12"	6-1/2"	3"

Available in Alder, Cherry, Maple, Red Oak & Rubberwood

Family Suites

"Leading the Pack"

SHAKER FAMILY

Two Sided Taper Toe

Family Suites

 Shaker Series
Legs are also available in 42" upon request
See Table Below & Page 137



Legs available in Alder, Cherry, Maple, Poplar, Red Oak & Rubberwood
Other Species upon request

Bun Feet available in Alder, Cherry, Maple, Pine, Poplar, Red Oak & Rubberwood
Other Species upon request

Item No.	Description	Tall	Overall Width	Taper Length to Floor	Toe
BAR98300P-2ST	Tapered Shaker Square	42"	3"	4"	2"
BAR98350P-2ST	Tapered Shaker Square	42"	3-1/2"	4"	2-1/2"
BAR98500P-2ST	Tapered Shaker Square	42"	5"	4"	4"
ISL98300P-2ST	Tapered Shaker Square	36"	3"	4"	2"
ISL98350P-2ST	Tapered Shaker Square	36"	3-1/2"	4"	2/1/2"
ISL98500P-2ST	Tapered Shaker Square	36"	5"	4"	4"
BF225-40	Tapered Square	4"	2-1/4"	3-1/2"	1-1/8"
BF225-50	Tapered Square	5"	2-1/4"	3-1/2"	1-1/8"
BF802	Tapered Square	3"	3"	3"	2-7/16"
BF803	Tapered Square	2-3/4"	3-1/2"	N/A	2-1/2"
BF805	Tapered Square	4-1/2"	3-1/4"	N/A	2-1/2"
BF820	Tapered Square	4-1/2"	4-1/2"	4-1/2"	3-5/8"
BF821	Tapered Square	4-1/2"	3-1/2"x4-1/2"	4-1/2"	2-1/2"x3-1/2"

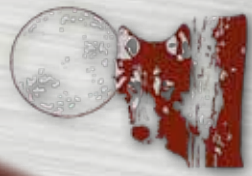

SHAKER FAMILY

Family Suites

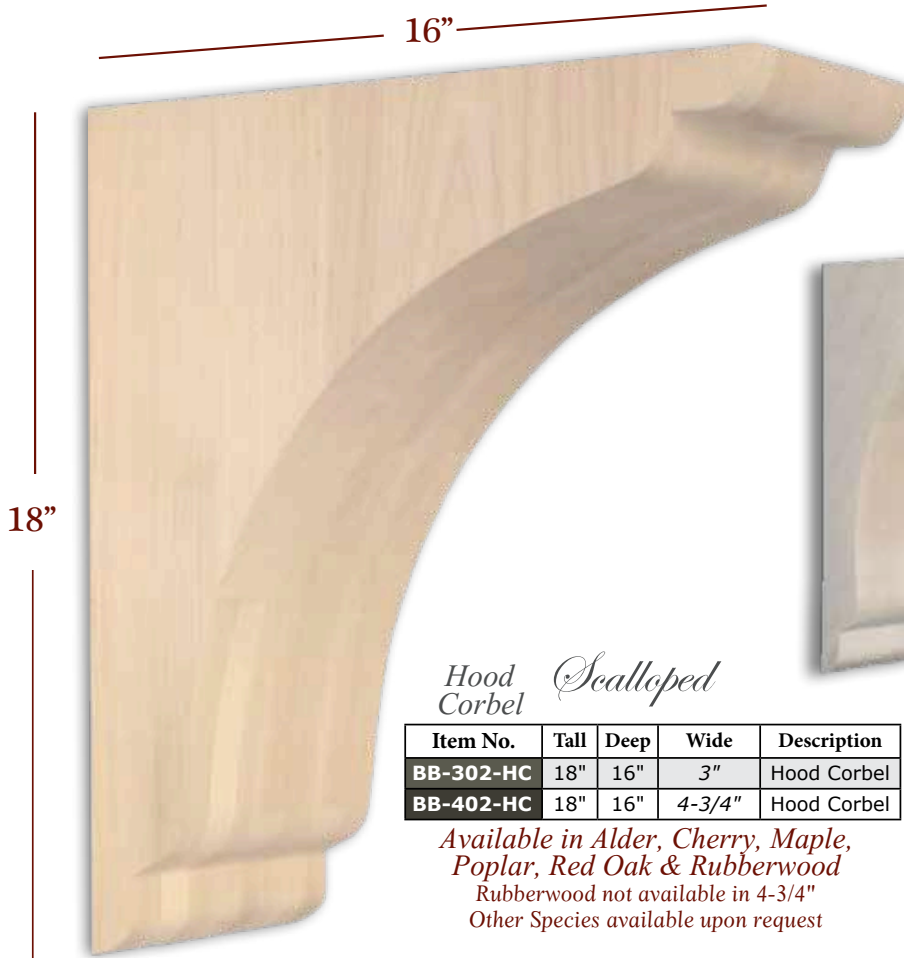

Hood Corbel Scalloped

Item No.	Tall	Deep	Wide	Description
BB-302-HC	18"	16"	3"	Hood Corbel
BB-402-HC	18"	16"	4-3/4"	Hood Corbel

Available in Alder, Cherry, Maple, Poplar, Red Oak & Rubberwood
 Rubberwood not available in 4-3/4"
 Other Species available upon request

Overhang Bracket Scalloped

Item No.	Tall	Deep	Wide	Description
BB-002-OH	10"	10"	1-3/4"	Overhang
BB-302-OH	10"	10"	3"	Overhang
BB-402-OH	10"	10"	4-3/4"	Overhang

Available in Alder, Cherry, Maple, Poplar, Red Oak & Rubberwood
 Rubberwood not available in 4-3/4"
 Other Species available upon request



Large Medium Small Extra Small

Bar Brackets Scalloped

	Item No.	Tall	Deep	Wide	Description
1-3/4" W	BB-002-L	14-5/32"	8"	1-3/4"	Large
	BB-002-M	10-5/8"	5-1/2"	1-3/4"	Medium
	BB-002-S	9"	5"	1-3/4"	Small
	BB-002-XS	7-3/16"	4"	1-3/4"	Extra Small
3" W	BB-302-L	14-5/32"	8"	3"	Large
	BB-302-M	10-5/8"	5-1/2"	3"	Medium
	BB-302-S	9"	5"	3"	Small
	BB-302-XS	7-3/16"	4"	3"	Extra Small
4-3/4" W	BB-402-L	14-5/32"	8"	4-3/4"	Large
	BB-402-M	10-5/8"	5-1/2"	4-3/4"	Medium
	BB-402-S	9"	5"	4-3/4"	Small
	BB-402-XS	7-3/16"	4"	4-3/4"	Extra Small

Available in Alder, Cherry, Maple, Poplar, Red Oak & Rubberwood
 Rubberwood not available in 4-3/4"
 Other Species available upon request

"Leading the Pack"

SKYLINE FAMILY ❄

Straight Plain

Family Suites

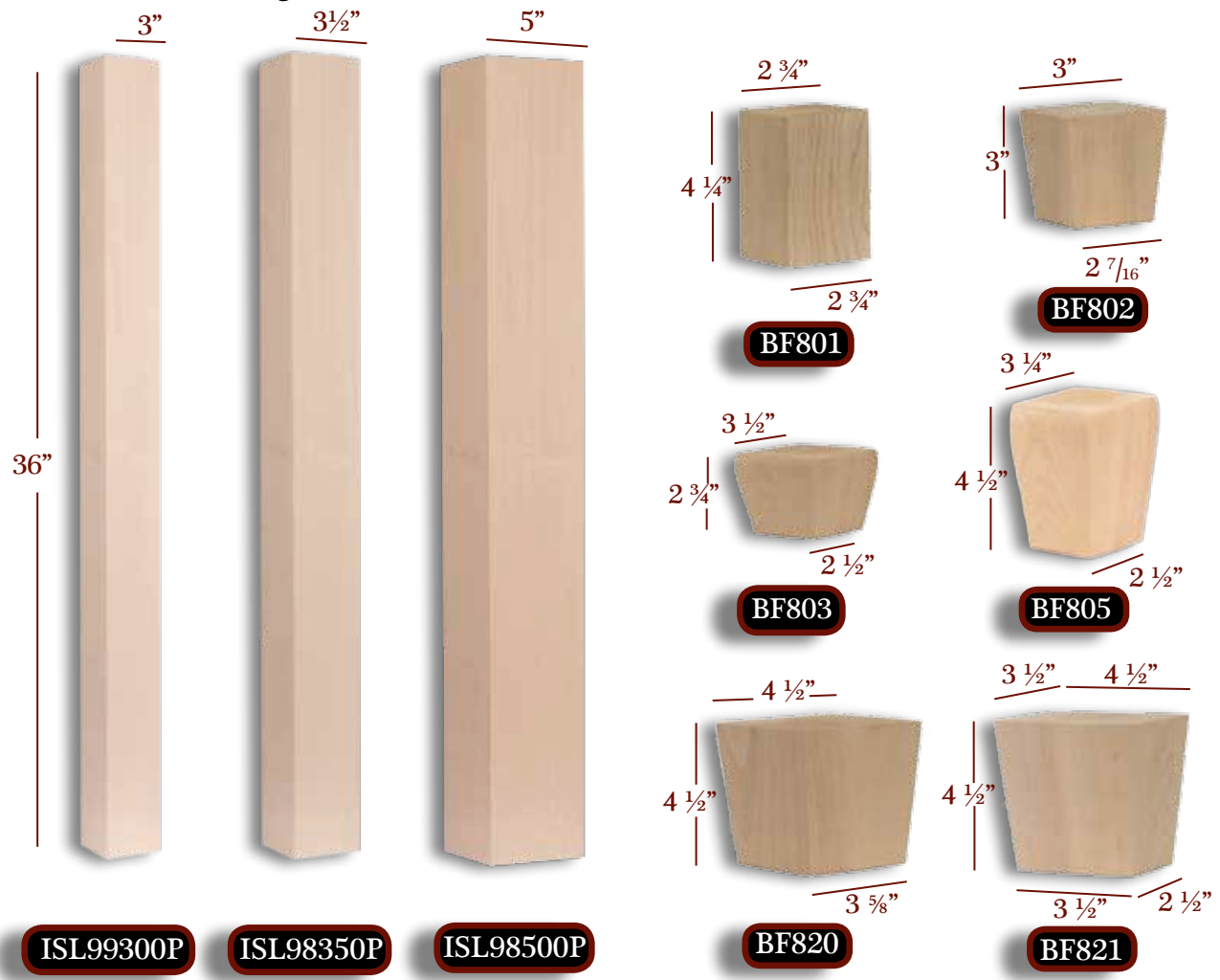

Legs available in Alder, Cherry, Maple, Poplar, Red Oak & Rubberwood Other Species upon request

Bun Feet available in Alder, Cherry, Maple, Pine, Poplar, Red Oak & Rubberwood Other Species upon request

Item No.	Description	Tall	Overall Width	Toe
BAR99300P	Plain Straight Square	42"	3"	N/A
BAR99350P	Plain Straight Square	42"	3-1/2"	N/A
BAR99500P	Plain Straight Square	42"	5"	N/A
ISL99300P	Plain Straight Square	36"	3"	N/A
ISL99350P	Plain Straight Square	36"	3-1/2"	N/A
ISL99500P	Plain Straight Square	36"	5"	N/A
BF801	Plain Straight Square	4-1/4"	2-3/4"	2-3/4"
BF802	Tapered Square	3"	3"	2-7/16"
BF803	Tapered Square	2-3/4"	3-1/2"	2-1/2"
BF805	Tapered Square	4-1/2"	3-1/4"	2-1/2"
BF820	Tapered Square	4-1/2"	4-1/2"	3-5/8"
BF821	Tapered Square	4-1/2"	3-1/2"x4-1/2"	2-1/2"x3-1/2"

❄ Skyline Series Posts are also available in 42" upon request
See Table Below & Page 137

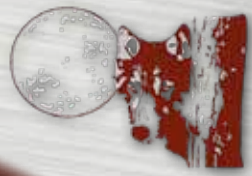

SKYLINE FAMILY

Family Suites



CBL-VM430



CBL-VM429



CBL-VM428



CBL-VM427



CBL-VM426

Mission

Item No.	Tall	Deep	Wide
CBL-VM430	36"	8"	8"
CBL-VM429	26-1/2"	7"	7"
CBL-VM428	18-1/2"	5-3/4"	5-3/4"
CBL-VM427	14"	5"	5"
CBL-VM426	10-1/2"	4"	4"

Available in Alder, Aspen, Cherry, Maple & Oak



Hood Corbel *Mission*

Item No.	Tall	Deep	Wide	Description
BB-308-HC	18"	16"	3"	Hood Corbel
BB-408-HC	18"	16"	4-3/4"	Hood Corbel

Available in Alder, Cherry, Maple, Poplar, Red Oak & Rubberwood
 Rubberwood not available in 4-3/4"
 Other Species available upon request



Overhang Bracket *Mission*

Item No.	Tall	Deep	Wide	Description
BB-008-OH	10"	10"	1-3/4"	Overhang
BB-308-OH	10"	10"	3"	Overhang
BB-408-OH	10"	10"	4-3/4"	Overhang

Available in Alder, Cherry, Maple, Poplar, Red Oak & Rubberwood
 Rubberwood not available in 4-3/4"
 Other Species available upon request

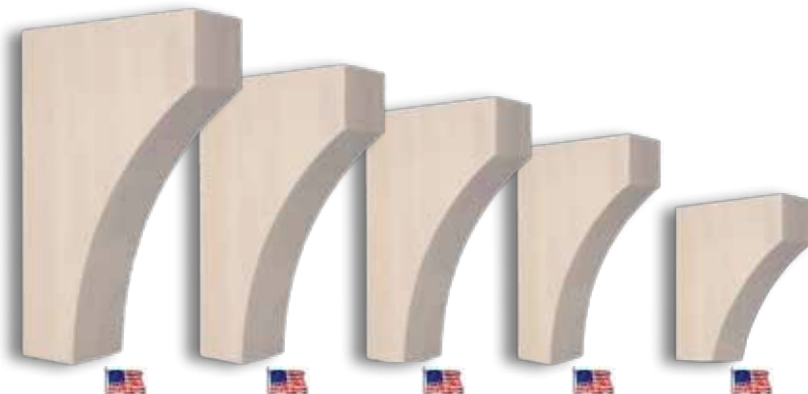

Large Medium Small Extra Small Petite

Bar Brackets *Mission*

	Item No.	Tall	Deep	Wide	Description
1-3/4" W	BB-008-L	12"	8"	1-3/4"	Large
	BB-008-M	9"	6-1/2"	1-3/4"	Medium
	BB-008-S	7-1/2"	5"	1-3/4"	Small
	BB-008-XS	6"	4"	1-3/4"	Extra Small
	BB-008-P	3"	3"	1-3/4"	Petite
3" W	BB-308-L	12"	8"	3"	Large
	BB-308-M	9"	6-1/2"	3"	Medium
	BB-308-S	7-1/2"	5"	3"	Small
	BB-308-XS	6"	4"	3"	Extra Small
	BB-308-P	3"	3"	3"	Petite
4-3/4" W	BB-408-L	12"	8"	4-3/4"	Large
	BB-408-M	9"	6-1/2"	4-3/4"	Medium
	BB-408-S	7-1/2"	5"	4-3/4"	Small
	BB-408-XS	6"	4"	4-3/4"	Extra Small
	BB-408-P	3"	3"	4-3/4"	Petite

Available in Alder, Cherry, Maple, Poplar, Red Oak & Rubberwood
 Other Species available upon request. Rubberwood not available in 4-3/4"

"Leading the Pack"

VANDERBILT FAMILY

Plain Square

Family Suites

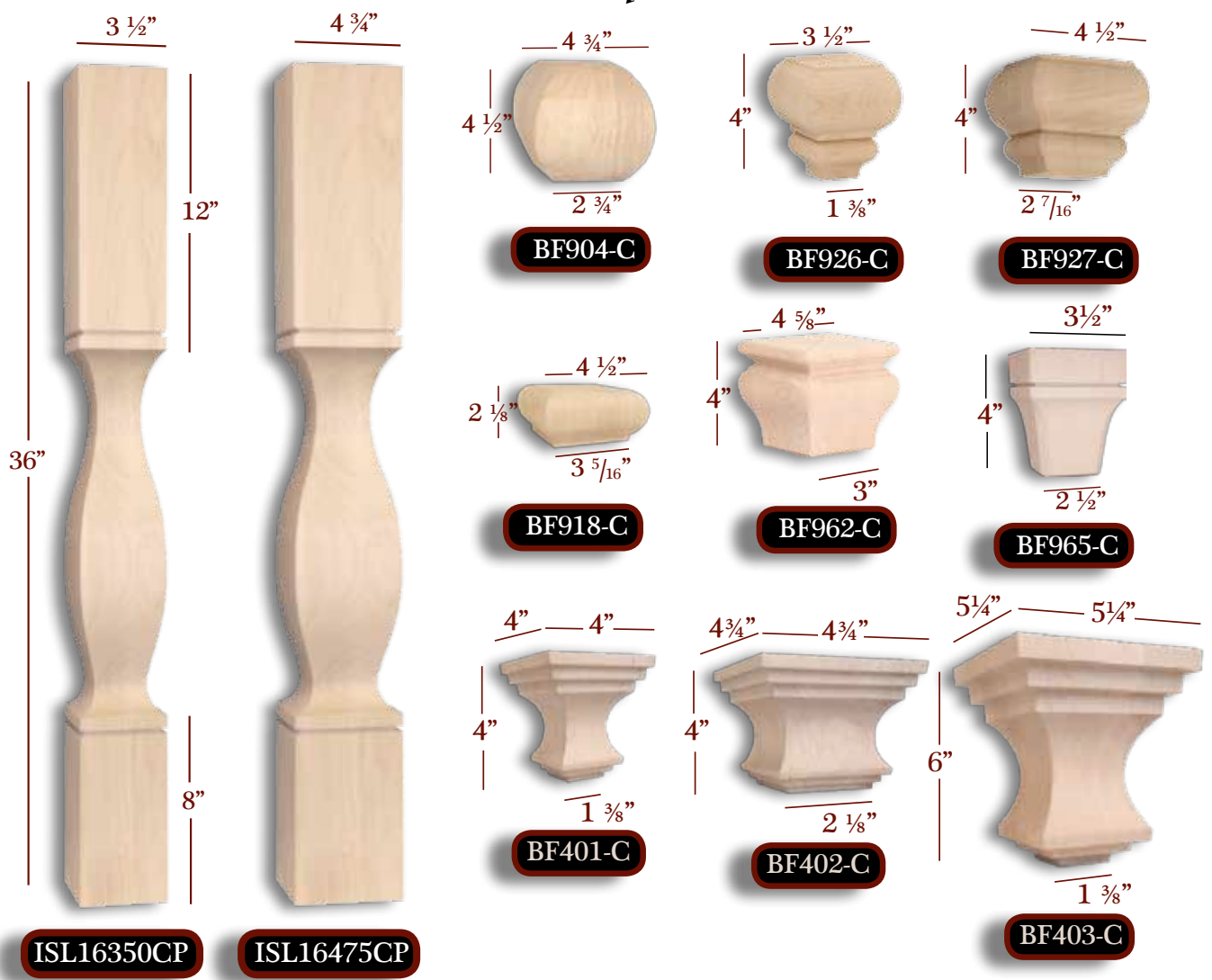

Item No.	Tall	Overall Width	Top Shank Length	Bottom Shank Length	Toe
ISL16350CP	36"	3-1/2"	12"	8"	N/A
ISL16475CP	36"	4-3/4"	12"	8"	N/A
BF904-C	4-1/2"	4-3/4"	N/A	N/A	2-3/4"
BF918-C	2-1/8"	4-1/2"	N/A	N/A	3-5/16"
BF926-C	4"	3-1/2"	N/A	N/A	1-3/8"
BF927-C	4"	4-1/2"	N/A	N/A	2-7/16"
BF962-C	4"	4-5/8"	N/A	N/A	3"
BF965-C	4"	3-1/2"	N/A	N/A	2-1/2"
BF401-C	4"	4"	N/A	N/A	1-3/8"
BF402-C	4"	4-3/4"	N/A	N/A	2-1/8"
BF403-C	6"	5-1/4"	N/A	N/A	1-3/8"

Available in Alder, Cherry, Maple, Poplar, Red Oak & Rubberwood
Other Species upon request

American Made

Phone: 877-504-WOLF
(9653)
sales@TimberWolfForest.com

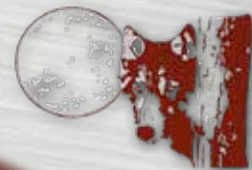

VANDERBILT FAMILY

Family Suites

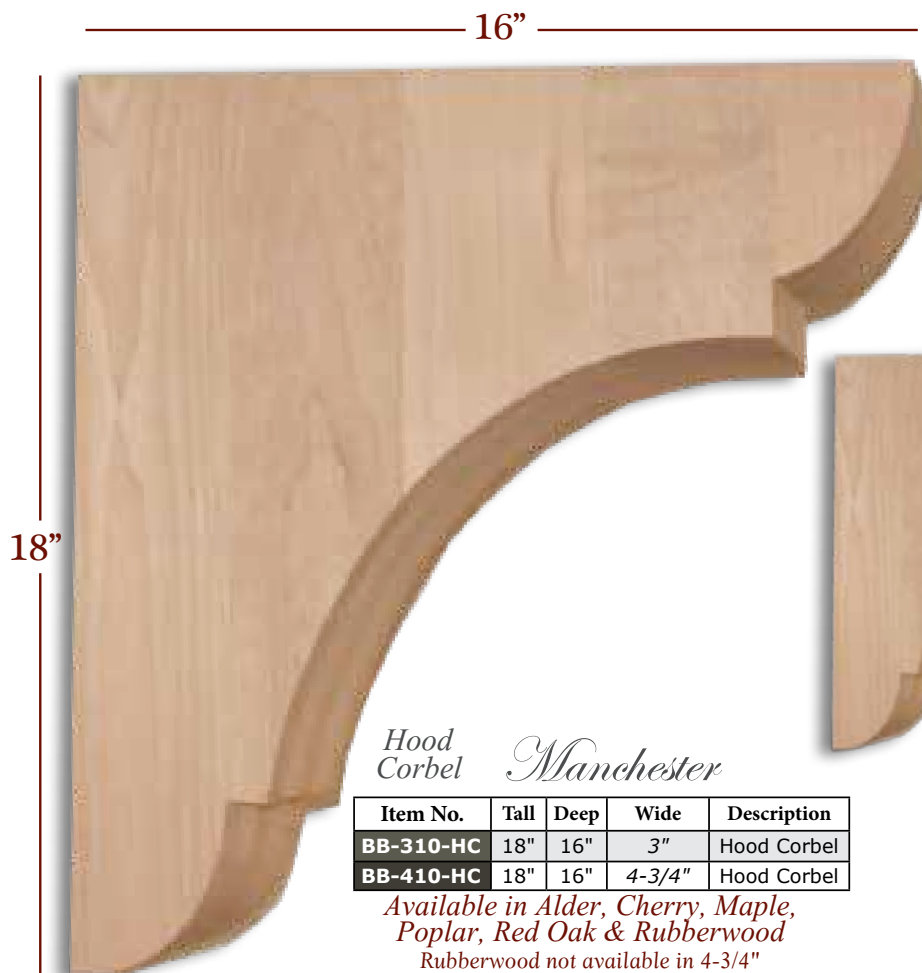

Hood Corbel *Manchester*

Item No.	Tall	Deep	Wide	Description
BB-310-HC	18"	16"	3"	Hood Corbel
BB-410-HC	18"	16"	4-3/4"	Hood Corbel

Available in Alder, Cherry, Maple, Poplar, Red Oak & Rubberwood
 Rubberwood not available in 4-3/4"
 Other Species available upon request

Overhang Bracket *Manchester*

Item No.	Tall	Deep	Wide	Description
BB-010-OH	10"	10"	1-3/4"	Overhang
BB-310-OH	10"	10"	3"	Overhang
BB-410-OH	10"	10"	4-3/4"	Overhang

Available in Alder, Cherry, Maple, Poplar, Red Oak & Rubberwood
 Rubberwood not available in 4-3/4"
 Other Species available upon request



Large Medium Small Extra Small Petite

Bar Brackets *Manchester*

	Item No.	Tall	Deep	Wide	Description
1-3/4" W	BB-010-L	12"	8"	1-3/4"	Large
	BB-010-M	9"	6-1/2"	1-3/4"	Medium
	BB-010-S	7-1/2"	5"	1-3/4"	Small
	BB-010-XS	6"	4"	1-3/4"	Extra Small
	BB-010-P	3"	3"	1-3/4"	Petite
3" W	BB-310-L	12"	8"	3"	Large
	BB-310-M	9"	6-1/2"	3"	Medium
	BB-310-S	7-1/2"	5"	3"	Small
	BB-310-XS	6"	4"	3"	Extra Small
	BB-310-P	3"	3"	3"	Petite
4-3/4" W	BB-410-L	12"	8"	4-3/4"	Large
	BB-410-M	9"	6-1/2"	4-3/4"	Medium
	BB-410-S	7-1/2"	5"	4-3/4"	Small
	BB-410-XS	6"	4"	4-3/4"	Extra Small

Available in Alder, Cherry, Maple, Poplar, Red Oak & Rubberwood
 Rubberwood not available in 4-3/4"
 Other Species available upon request



"Leading the Pack"

VICTORIA FAMILY*

Family Suites

Plain/
Fluted

Plain/
Plain

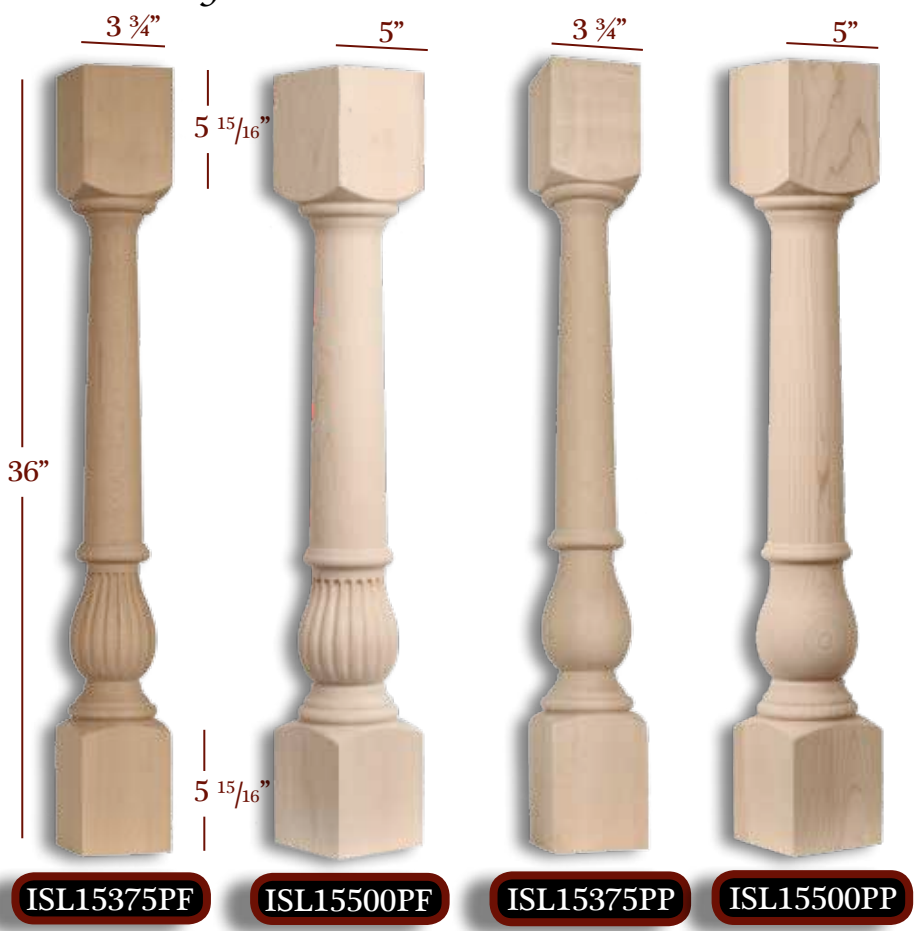

Item No.	Desc.	Tall	Overall Width	Top Shank Length	Bottom Shank Length	Toe
BAR15300PF	Plain/Fluted	42"	3"	8"	5-15/16"	N/A
BAR15375PF	Plain/Fluted	42"	3-3/4"	8"	5-15/16"	N/A
BAR15500PF	Plain/Fluted	42"	5"	8"	5-15/16"	N/A
ISL15300PF	Plain/Fluted	36"	3"	5-15/16"	5-15/16"	N/A
ISL15375PF	Plain/Fluted	36"	3-3/4"	5-15/16"	5-15/16"	N/A
ISL15500PF	Plain/Fluted	36"	5"	5-15/16"	5-15/16"	N/A
BAR15300PP	Plain/Plain	42"	3"	8"	5-15/16"	N/A
BAR15375PP	Plain/Plain	42"	3-3/4"	8"	5-15/16"	N/A
BAR15500PP	Plain/Plain	42"	5"	8"	5-15/16"	N/A
ISL15300PP	Plain/Plain	36"	3"	5-15/16"	5-15/16"	N/A
ISL15375PP	Plain/Plain	36"	3-3/4"	5-15/16"	5-15/16"	N/A
ISL15500PP	Plain/Plain	36"	5"	5-15/16"	5-15/16"	N/A
BF913	Plain	9-1/8"	3-3/8"	N/A	N/A	7/8"
BF916	Roped	5-1/2"	3-1/2"	N/A	N/A	1-1/16"
BF945	Roped	5"	3-1/2"	N/A	N/A	1-5/8"
BF952	Plain	6"	3-1/2"	N/A	N/A	1-1/2"
BF966	Plain	4"	3-1/2"	N/A	N/A	1-13/16"
ML1101F	Fluted	11"	2-5/8"	3"	N/A	1-1/16"

Available in Alder, Cherry, Maple, Poplar, Red Oak & Rubberwood
Other Species upon request

* Victoria Series Posts are also available in 42" See Tables

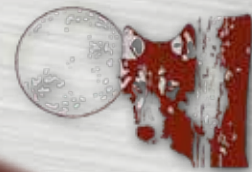

VICTORIA FAMILY ❄

*Fluted/
Fluted*

*Fluted/
Plain*

*Roped/
Plain*

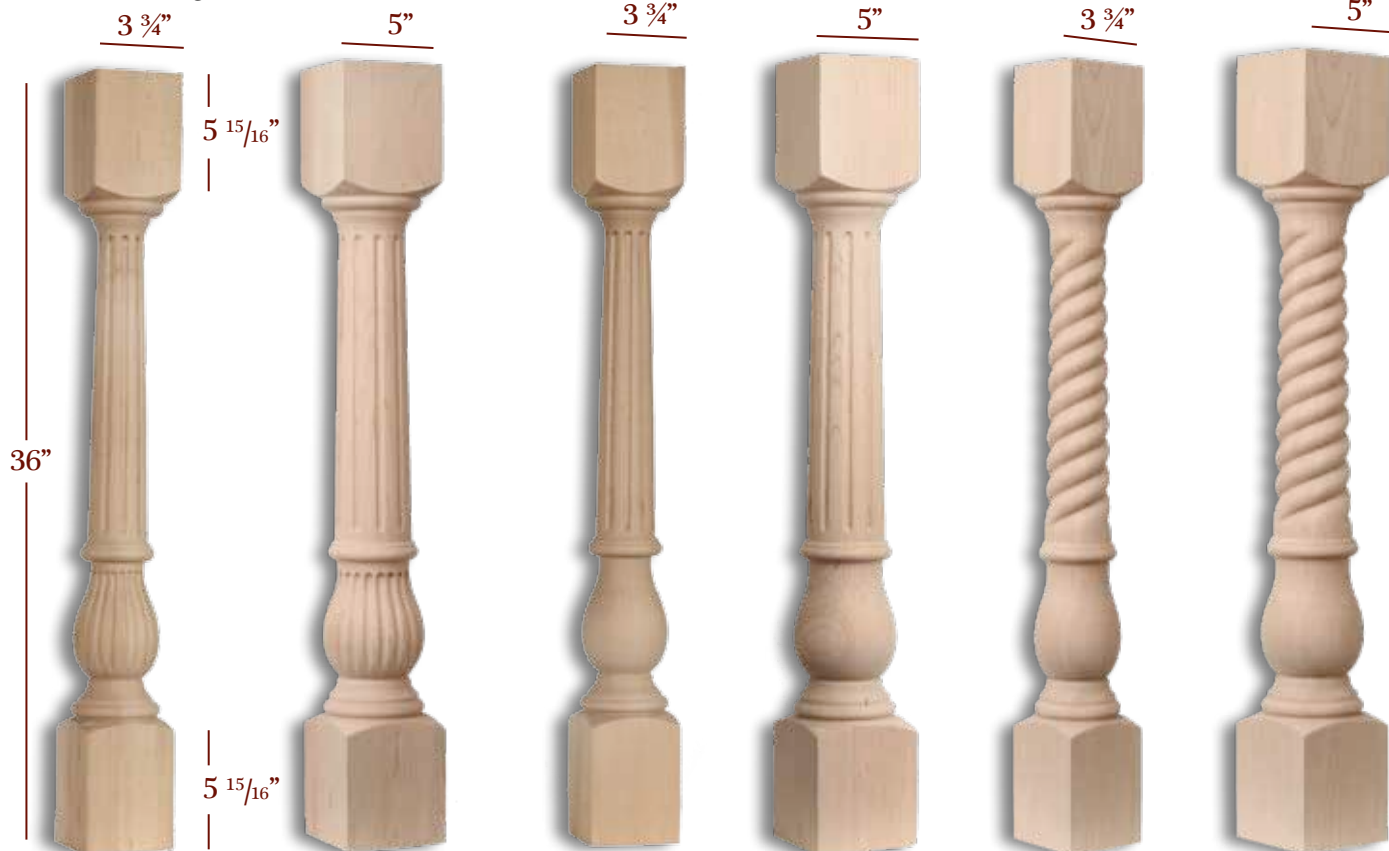

ISL15375FF

ISL15500FF

ISL15375FP

ISL15500FP

ISL15375RP

ISL15500RP

Family Suites

Item No.	Desc.	Tall	Width	Top Shank Length	Bottom Shank Length
BAR15375FF	Fluted/Fluted	42"	3-3/4"	8"	5-15/16"
BAR15500FF	Fluted/Fluted	42"	5"	8"	5-15/16"
ISL15375FF	Fluted/Fluted	36"	3-3/4"	5-15/16"	5-15/16"
ISL15500FF	Fluted/Fluted	36"	5"	5-15/16"	5-15/16"
BAR15375FP	Fluted/Plain	42"	3-3/4"	8"	5-15/16"
BAR15500FP	Fluted/Plain	42"	5"	8"	5-15/16"
ISL15375FP	Fluted/Plain	36"	3-3/4"	5-15/16"	5-15/16"
ISL15500FP	Fluted/Plain	36"	5"	5-15/16"	5-15/16"
BAR15375RP	Roped/Plain	42"	3-3/4"	8"	5-15/16"
BAR15500RP	Roped/Plain	42"	5"	8"	5-15/16"
ISL15375RP	Roped/Plain	36"	3-3/4"	5-15/16"	5-15/16"
ISL15500RP	Roped/Plain	36"	5"	5-15/16"	5-15/16"



Maverick
CBL-002-M



Vita
CBL-003-M

*Corbels available
in Alder, Cherry,
Maple, Poplar &
Red Oak
Other Species
upon request*

*Posts available in Alder, Cherry, Maple,
Poplar, Red Oak & Rubberwood
Other Species upon request*

Item No.	Tall	Deep	Wide
CBL-002-M	10-1/16"	6"	3-1/2"
CBL-003-M	10"	6-7/16"	3"



"Leading the Pack"

WILLIAMSBURG FAMILY

Family Suites

Plain



ISL12300P

ISL12350P

ISL12375P

ISL12500P

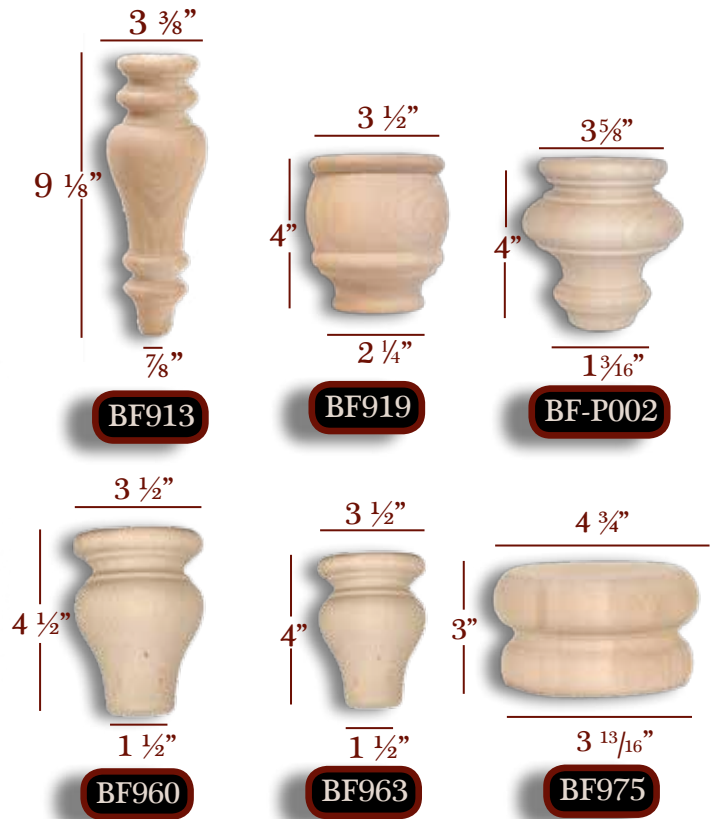

BF913

BF919

BF-P002

BF960

BF963

BF975

Bun Feet available in Alder, Cherry, Maple, Pine, Poplar, Red Oak & Rubberwood
Other Species upon request

Posts available in Alder, Cherry, Maple, Poplar, Red Oak & Rubberwood
Other Species upon request

 Williamsburg Series Posts are available in 42"

Item No.	Desc.	Tall	Overall Width	Top Shank Length	Bottom Shank Length	Block	Toe
BAR12300P	Plain Round	42"	3"	13"	7"	N/A	N/A
BAR12350P	Plain Round	42"	3-1/2"	13"	7"	N/A	N/A
BAR12500P	Plain Round	42"	5"	13"	7"	N/A	N/A
ISL12300P	Plain Round	36"	3"	7"	7"	N/A	N/A
ISL12350P	Plain Round	36"	3-1/2"	7"	7"	N/A	N/A
ISL12375P	Plain Round	36"	3-3/4"	7"	7"	N/A	N/A
ISL12500P	Plain Round	36"	5"	7"	7"	N/A	N/A
BF913	Plain	9-1/8"	3-3/8"	N/A	N/A	N/A	7/8"
BF919	Plain	4"	3-1/2"	N/A	N/A	N/A	2-1/4"
BF960	Plain	4-1/2"	3-1/2"	N/A	N/A	N/A	1-1/2"
BF963	Plain	4"	3-1/2"	N/A	N/A	N/A	1-1/2"
BF975	Plain	3"	4-3/4"	N/A	N/A	N/A	3-13/16"
BF-P002	Plain	4"	3-5/8"	N/A	N/A	N/A	1-3/16"

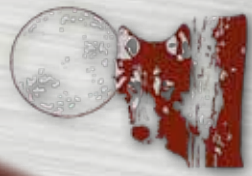

WILLIAMSBURG FAMILY

Family Suites

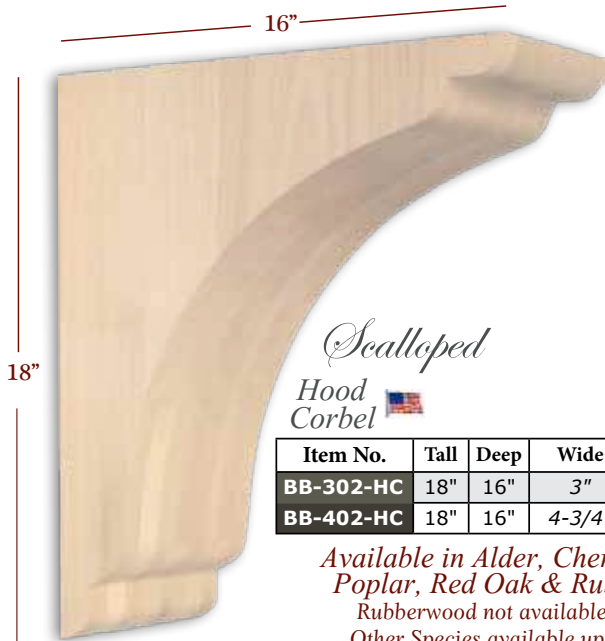

Scalloped
Hood Corbel

Item No.	Tall	Deep	Wide	Description
BB-302-HC	18"	16"	3"	Hood Corbel
BB-402-HC	18"	16"	4-3/4"	Hood Corbel

Available in Alder, Cherry, Maple, Poplar, Red Oak & Rubberwood
Rubberwood not available in 4-3/4"
Other Species available upon request



Scalloped
Overhang Bracket

Item No.	Tall	Deep	Wide	Description
BB-002-OH	10"	10"	1-3/4"	Overhang
BB-302-OH	10"	10"	3"	Overhang
BB-402-OH	10"	10"	4-3/4"	Overhang

Available in Alder, Cherry, Maple, Poplar, Red Oak & Rubberwood
Rubberwood not available in 4-3/4"
Other Species available upon request

Scalloped
Bar Brackets

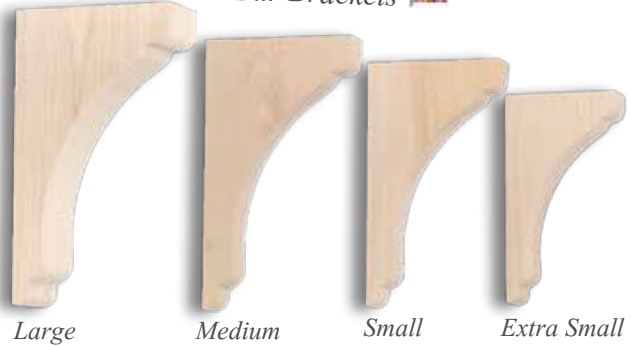

	Item No.	Tall	Deep	Wide	Description
1-3/4" W	BB-002-L	14-5/32"	8"	1-3/4"	Large
	BB-002-M	10-5/8"	5-1/2"	1-3/4"	Medium
	BB-002-S	9"	5"	1-3/4"	Small
	BB-002-XS	7-3/16"	4"	1-3/4"	Extra Small
3" W	BB-302-L	14-5/32"	8"	3"	Large
	BB-302-M	10-5/8"	5-1/2"	3"	Medium
	BB-302-S	9"	5"	3"	Small
	BB-302-XS	7-3/16"	4"	3"	Extra Small
4-3/4" W	BB-402-L	14-5/32"	8"	4-3/4"	Large
	BB-402-M	10-5/8"	5-1/2"	4-3/4"	Medium
	BB-402-S	9"	5"	4-3/4"	Small
	BB-402-XS	7-3/16"	4"	4-3/4"	Extra Small

Available in Alder, Cherry, Maple, Poplar, Red Oak & Rubberwood
Rubberwood not available in 4-3/4"
Other Species available upon request



Athena
CBL-001-L



Athena
CBL-001-M



Athena
CBL-001-S

Traditional

Item No.	Tall	Deep	Wide
CBL-001-S	6-3/4"	3-3/4"	3-1/2"
CBL-001-M	10"	5"	5"
CBL-001-L	14"	7"	5-1/4"

Available in Alder, Cherry, Maple, Poplar & Red Oak



Traditional
CBL-PT5

Item No.	Tall	Deep	Wide
CBL-PT5	4-1/4"	1-3/4"	2-7/8"

Available in Alder, Cherry, Maple, Red Oak & Rubberwood



Traditional
CBL-PT4

Item No.	Tall	Deep	Wide
CBL-PT4	13"	7-3/4"	3-3/8"

Available in Alder, Cherry, Maple, Red Oak & Rubberwood

"Leading the Pack"

WINSTON FAMILY ❄

Family Suites

Plain

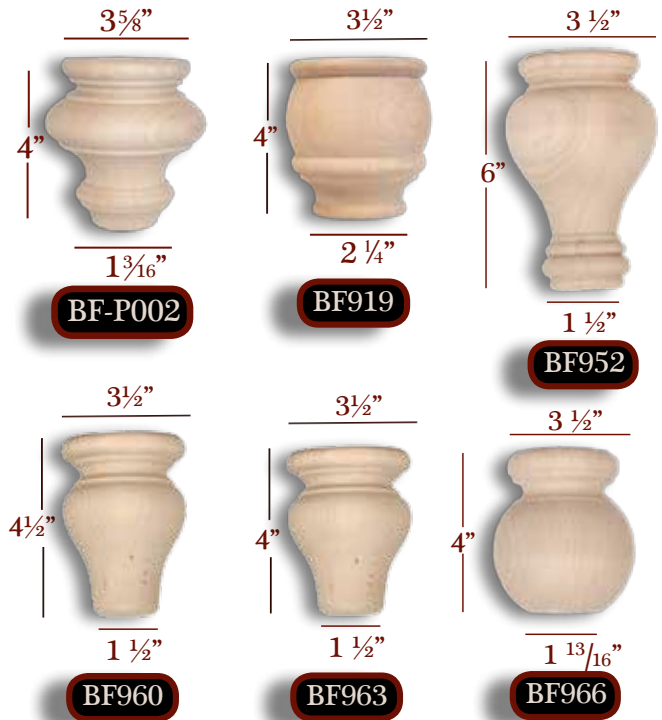
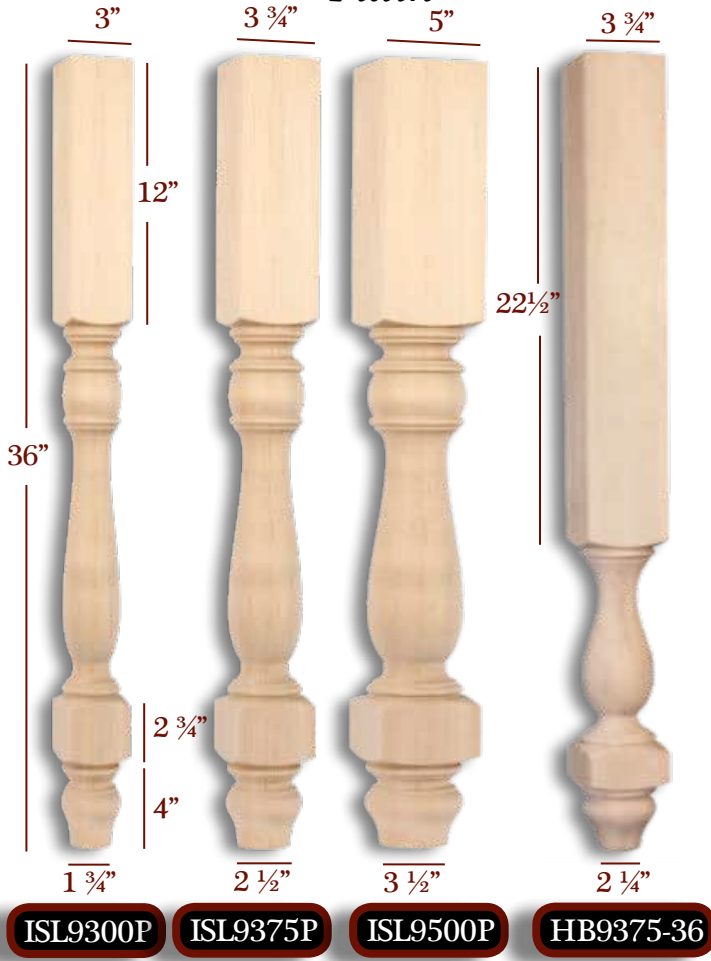

❄ Winston Series
Island Legs are also available in 29"
See Page 181

Item No.	Desc.	Tall	Overall Width	Top Shank Length	Bottom Shank Length	Block	Toe
ISL9300P	Plain Round	36"	3"	12"	N/A	2-3/4"	1-3/4"
ISL9375P	Plain Round	36"	3-3/4"	12"	N/A	2-3/4"	2-1/2"
ISL9500P	Plain Round	36"	5"	12"	N/A	2-3/4"	3-1/2"
HB9300P-36	Plain Round	36"	3"	22-1/2"	N/A	1-3/4"	1-1/2"
HB9350P-36	Plain Round	36"	3-1/2"	22-1/2"	N/A	1-3/4"	2"
HB9375P-36	Plain Round	36"	3-3/4"	22-1/2"	N/A	1-3/4"	2-1/4"
HB9500P-36	Plain Round	36"	5"	22-1/2"	N/A	1-3/4"	3-1/2"
BF-P002	Plain	4"	3-5/8"	N/A	N/A	N/A	1-3/16"
BF919	Plain	4"	3-1/2"	N/A	N/A	N/A	2-1/4"
BF952	Plain	6"	3-1/2"	N/A	N/A	N/A	1-1/2"
BF960	Plain	4-1/2"	3-1/2"	N/A	N/A	N/A	1-1/2"
BF963	Plain	4"	3-1/2"	N/A	N/A	N/A	1-1/2"
BF966	Plain	4"	3-1/2"	N/A	N/A	N/A	1-13/16"

Available in Alder, Cherry, Maple, Poplar, Red Oak & Rubberwood
Other Species upon request

WINSTON FAMILY

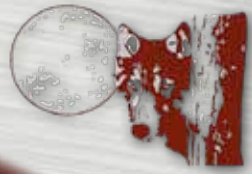

Family Suites

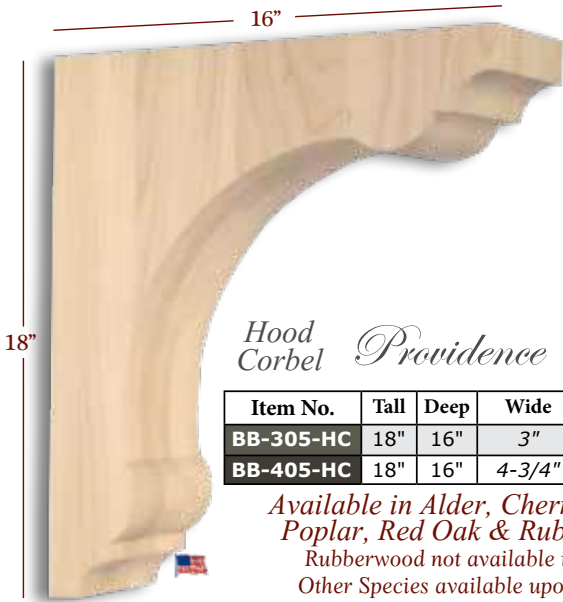

Hood Corbel *Providence*

Item No.	Tall	Deep	Wide	Description
BB-305-HC	18"	16"	3"	Hood Corbel
BB-405-HC	18"	16"	4-3/4"	Hood Corbel

Available in Alder, Cherry, Maple, Poplar, Red Oak & Rubberwood
 Rubberwood not available in 4-3/4"
 Other Species available upon request



Bar Brackets *Providence*

	Item No.	Tall	Deep	Wide	Description
1-3/4" W	BB-005-L	12-1/2"	6-1/2"	1-3/4"	Large
	BB-005-M	9-9/16"	5"	1-3/4"	Medium
	BB-005-S	7-3/4"	4"	1-3/4"	Small
	BB-005-XS	6-5/16"	3-1/4"	1-3/4"	Extra Small
3" W	BB-305-L	12-1/2"	6-1/2"	3"	Large
	BB-305-M	9-9/16"	5"	3"	Medium
	BB-305-S	7-3/4"	4"	3"	Small
	BB-305-XS	6-5/16"	3-1/4"	3"	Extra Small
4-3/4" W	BB-405-L	12-1/2"	6-1/2"	4-3/4"	Large
	BB-405-M	9-9/16"	5"	4-3/4"	Medium
	BB-405-S	7-3/4"	4"	4-3/4"	Small
	BB-405-XS	6-5/16"	3-1/4"	4-3/4"	Extra Small

Available in Alder, Cherry, Maple, Poplar, Red Oak & Rubberwood
 Rubberwood not available in 4-3/4"
 Other Species available upon request

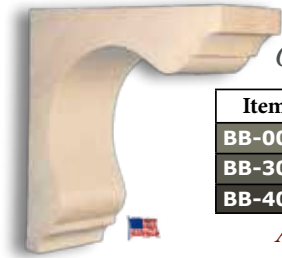

Overhang Bracket *Providence*

Item No.	Tall	Deep	Wide	Description
BB-005-OH	10"	10"	1-3/4"	Overhang
BB-305-OH	10"	10"	3"	Overhang
BB-405-OH	10"	10"	4-3/4"	Overhang

Available in Alder, Cherry, Maple, Poplar, Red Oak & Rubberwood
 Rubberwood not available in 4-3/4"
 Other Species available upon request



CBL-PT3



CBL-PT2



CBL-PT1



CBL-PT4



CBL-PT5

Traditional

Item No.	Tall	Deep	Wide	Description	Species
CBL-PT1	10"	5-1/4"	4-1/2"	Corbel - Small Trad. Corbel	These Items are available in Alder, Cherry, Maple, Red Oak, & Rubberwood
CBL-PT2	14"	7"	5"	Corbel - Medium Trad. Corbel	
CBL-PT3	22"	7-5/8"	6-3/4"	Corbel - Large Trad. Corbel	
CBL-PT4	13"	7-3/4"	3-3/8"	Corbel - Traditional Bar Bracket	
CBL-PT5	4-1/4"	1-3/4"	2-7/8"	Corbel - Mini Traditional	

"Leading the Pack"

CORBELS, BRACKETS, APPLIQUES & ONLAYS



CBL-002-M & CBL-003-M
Shown in Picture

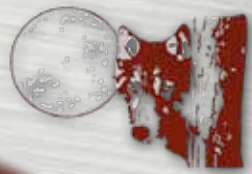

CORBELS, BRACKETS & ONLAYS DESIGN INDEX



Plain
Brackets
& Corbels



Scalloped
Brackets
& Corbels



Cove
Brackets
& Corbels



Lexington
Brackets
& Corbels



Providence
Brackets
& Corbels



Cortez
Brackets
& Corbels



Mission
Brackets
& Corbels



Nantucket
Brackets
& Corbels



Manchester
Brackets
& Corbels



Rockefeller
Corbel

Houston
Corbel



Acanthus
Corbels



Acanthus
Corbels



Acanthus
Corbels



Acanthus
Corbels



Acanthus
Corbels



Acanthus
Corbels



Acanthus
Corbels



Mission
Corbels



Mission
Corbels



Mission
Corbels



Mission
Corbels



Mission
Corbels



Mission
Corbels



Mission
Corbels



Mission
Corbels



Traditional
Corbels



Traditional
Corbels



Traditional
Corbels



Traditional
Corbels



Traditional
Corbels



Traditional
Corbels



Traditional
Corbels



Traditional
Corbels



Transitional
Corbels



Transitional
Corbels



Transitional
Corbels



Transitional
Corbels



Transitional
Corbels



Transitional
Corbels

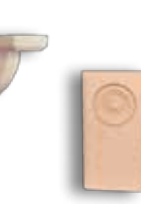

Transitional
Corbels



Plyth Block

Rosette



Onlays



Appliques & Capitals

"Leading the Pack"

Corbels, Brackets & Onlays

TRANSFORM YOUR KITCHEN

WITH OUR LINE OF
BRACKETS AND CORBELS

BEFORE

AFTER



BB-612-MHC
Detail



See page 100 & 101 for
the Trim to Fit Corbels



American Made



Phone: 877-504-WOLF
(9653)
sales@TimberWolfForest.com

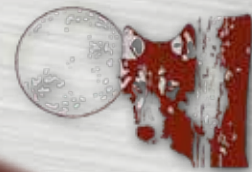

BRACKETS & HOOD CORBELS

Corbels, Brackets & Onlays



Plain

Hood Corbel

Item No.	Tall	Deep	Wide	Description
BB-301-HC	18"	16"	3"	Hood Corbel
BB-401-HC	18"	16"	4-3/4"	Hood Corbel

Bar Brackets

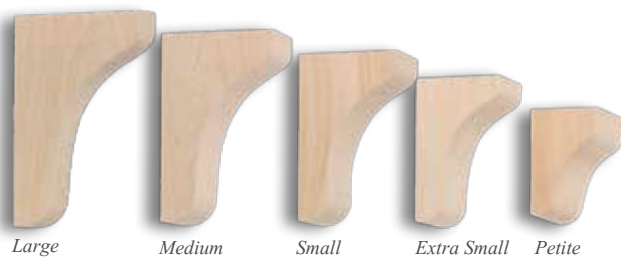

	Item No.	Tall	Deep	Wide	Description
1-3/4" W	BB-001-L	12-7/8"	8"	1-3/4"	Large
	BB-001-M	9-5/8"	6"	1-3/4"	Medium
	BB-001-S	8-1/16"	5"	1-3/4"	Small
	BB-001-XS	6-1/2"	4"	1-3/4"	Extra Small
	BB-001-P	3"	1-1/2"	1-3/4"	Petite



Overhang Bracket

*Available in Alder, Cherry, Maple, Poplar, Red Oak & Rubberwood
Rubberwood not available in 4-3/4"
Other Species available upon request*

Item No.	Tall	Deep	Wide	Description
BB-001-OH	10"	10"	1-3/4"	Overhang
BB-301-OH	10"	10"	3"	Overhang
BB-401-OH	10"	10"	4-3/4"	Overhang

	Item No.	Tall	Deep	Wide	Description
3" W	BB-301-L	12-7/8"	8"	3"	Large
	BB-301-M	9-5/8"	6"	3"	Medium
	BB-301-S	8-1/16"	5"	3"	Small
	BB-301-XS	6-1/2"	4"	3"	Extra Small
	BB-301-P	3"	1-1/2"	3"	Petite

	Item No.	Tall	Deep	Wide	Description
4-3/4" W	BB-401-L	12-7/8"	8"	4-3/4"	Large
	BB-401-M	9-5/8"	6"	4-3/4"	Medium
	BB-401-S	8-1/16"	5"	4-3/4"	Small
	BB-401-XS	6-1/2"	4"	4-3/4"	Extra Small
	BB-401-P	3"	1-1/2"	4-3/4"	Petite



Scalloped

Hood Corbel

Item No.	Tall	Deep	Wide	Description
BB-302-HC	18"	16"	3"	Hood Corbel
BB-402-HC	18"	16"	4-3/4"	Hood Corbel

Bar Brackets

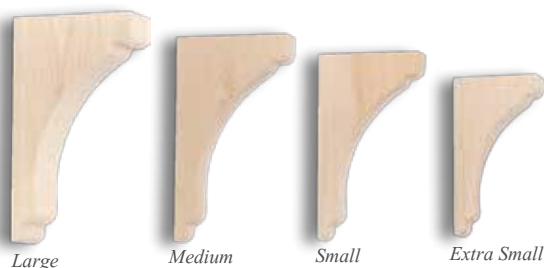

	Item No.	Tall	Deep	Wide	Description
1-3/4" W	BB-002-L	14-5/32"	8"	1-3/4"	Large
	BB-002-M	10-5/8"	5-1/2"	1-3/4"	Medium
	BB-002-S	9"	5"	1-3/4"	Small
	BB-002-XS	7-3/16"	4"	1-3/4"	Extra Small

	Item No.	Tall	Deep	Wide	Description
3" W	BB-302-L	14-5/32"	8"	3"	Large
	BB-302-M	10-5/8"	5-1/2"	3"	Medium
	BB-302-S	9"	5"	3"	Small
	BB-302-XS	7-3/16"	4"	3"	Extra Small

	Item No.	Tall	Deep	Wide	Description
4-3/4" W	BB-402-L	14-5/32"	8"	4-3/4"	Large
	BB-402-M	10-5/8"	5-1/2"	4-3/4"	Medium
	BB-402-S	9"	5"	4-3/4"	Small
	BB-402-XS	7-3/16"	4"	4-3/4"	Extra Small



Overhang Bracket

*Available in Alder, Cherry, Maple, Poplar, Red Oak & Rubberwood
Rubberwood not available in 4-3/4"
Other Species available upon request*

Item No.	Tall	Deep	Wide	Description
BB-002-OH	10"	10"	1-3/4"	Overhang
BB-302-OH	10"	10"	3"	Overhang
BB-402-OH	10"	10"	4-3/4"	Overhang



"Leading the Pack"

BRACKETS & HOOD CORBELS

Corbels, Brackets & Onlays



Cove 

Hood Corbel

Item No.	Tall	Deep	Wide	Description
BB-303-HC	18"	16"	3"	Hood Corbel
BB-403-HC	18"	16"	4-3/4"	Hood Corbel



Overhang Bracket

Item No.	Tall	Deep	Wide	Description
BB-003-OH	9-3/4"	9-3/4"	1-3/4"	Overhang
BB-303-OH	9-3/4"	9-3/4"	3"	Overhang
BB-403-OH	9-3/4"	9-3/4"	4-3/4"	Overhang

Available in Alder, Cherry, Maple, Poplar, Red Oak & Rubberwood
 Rubberwood not available in 4-3/4"
 Other Species available upon request

Bar Brackets



	Item No.	Tall	Deep	Wide	Description
1-3/4" W	BB-003-L	12-5/8"	8"	1-3/4"	Large
	BB-003-M	9-1/2"	4-7/8"	1-3/4"	Medium
	BB-003-S	8"	5"	1-3/4"	Small
	BB-003-XS	6-3/8"	4"	1-3/4"	Extra Small
3" W	BB-303-L	12-5/8"	8"	3"	Large
	BB-303-M	9-1/2"	4-7/8"	3"	Medium
	BB-303-S	8"	5"	3"	Small
	BB-303-XS	6-3/8"	4"	3"	Extra Small
4-3/4" W	BB-403-L	12-5/8"	8"	4-3/4"	Large
	BB-403-M	9-1/2"	4-7/8"	4-3/4"	Medium
	BB-403-S	8"	5"	4-3/4"	Small
	BB-403-XS	6-3/8"	4"	4-3/4"	Extra Small

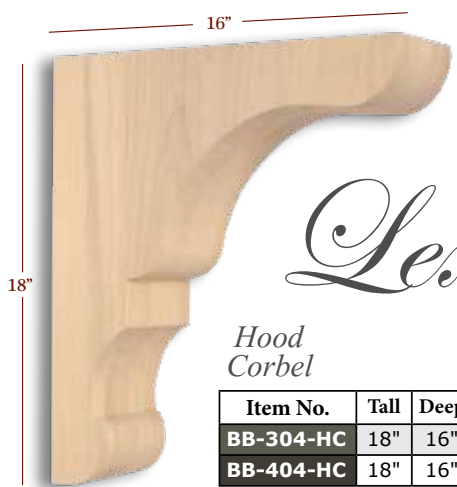

Lexington 

Hood Corbel

Item No.	Tall	Deep	Wide	Description
BB-304-HC	18"	16"	3"	Hood Corbel
BB-404-HC	18"	16"	4-3/4"	Hood Corbel



Overhang Bracket

Item No.	Tall	Deep	Wide	Description
BB-004-OH	10"	10"	1-3/4"	Overhang
BB-304-OH	10"	10"	3"	Overhang
BB-404-OH	10"	10"	4-3/4"	Overhang

Available in Alder, Cherry, Maple, Poplar, Red Oak & Rubberwood
 Rubberwood not available in 4-3/4"
 Other Species available upon request

Bar Brackets

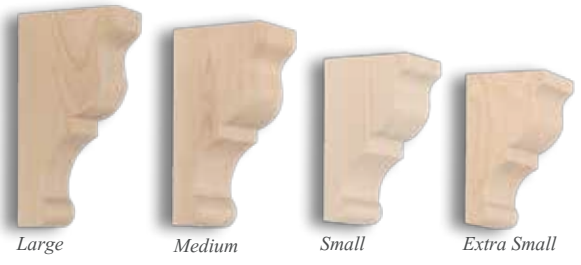

	Item No.	Tall	Deep	Wide	Description
1-3/4" W	BB-004-L	12-3/4"	6-9/16"	1-3/4"	Large
	BB-004-M	9-1/2"	4-7/8"	1-3/4"	Medium
	BB-004-S	7-1/2"	4-1/4"	1-3/4"	Small
	BB-004-XS	6-1/8"	3-1/2"	1-3/4"	Extra Small
3" W	BB-304-L	12-3/4"	6-9/16"	3"	Large
	BB-304-M	9-1/2"	4-7/8"	3"	Medium
	BB-304-S	7-1/2"	4-1/4"	3"	Small
	BB-304-XS	6-1/8"	3-1/2"	3"	Extra Small
4-3/4" W	BB-404-L	12-3/4"	6-9/16"	4-3/4"	Large
	BB-404-M	9-1/2"	4-7/8"	4-3/4"	Medium
	BB-404-S	7-1/2"	4-1/4"	4-3/4"	Small
	BB-404-XS	6-1/8"	3-1/2"	4-3/4"	Extra Small

BRACKETS & HOOD CORBELS

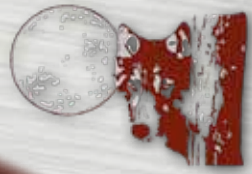

Providence

Hood Corbel

Item No.	Tall	Deep	Wide	Description
BB-305-HC	18"	16"	3"	Hood Corbel
BB-405-HC	18"	16"	4-3/4"	Hood Corbel

Bar Brackets

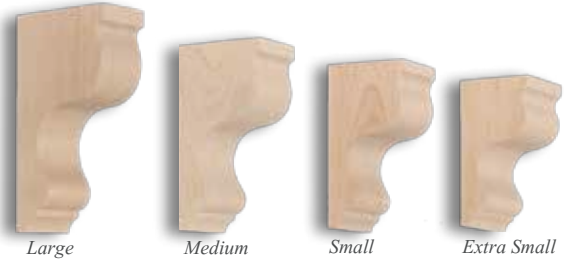

	Item No.	Tall	Deep	Wide	Description
1-3/4" W	BB-005-L	12-1/2"	6-1/2"	1-3/4"	Large
	BB-005-M	9-9/16"	5"	1-3/4"	Medium
	BB-005-S	7-3/4"	4"	1-3/4"	Small
	BB-005-XS	6-5/16"	3-1/4"	1-3/4"	Extra Small



Overhang Bracket

Item No.	Tall	Deep	Wide	Description
BB-005-OH	10"	10"	1-3/4"	Overhang
BB-305-OH	10"	10"	3"	Overhang
BB-405-OH	10"	10"	4-3/4"	Overhang

Available in Alder, Cherry, Maple, Poplar, Red Oak & Rubberwood
 Rubberwood not available in 4-3/4"
 Other Species available upon request

3" W	BB-305-L	12-1/2"	6-1/2"	3"	Large
	BB-305-M	9-9/16"	5"	3"	Medium
	BB-305-S	7-3/4"	4"	3"	Small
	BB-305-XS	6-5/16"	3-1/4"	3"	Extra Small

4-3/4" W	BB-405-L	12-1/2"	6-1/2"	4-3/4"	Large
	BB-405-M	9-9/16"	5"	4-3/4"	Medium
	BB-405-S	7-3/4"	4"	4-3/4"	Small
	BB-405-XS	6-5/16"	3-1/4"	4-3/4"	Extra Small



Cortez

Hood Corbel

Item No.	Tall	Deep	Wide	Description
BB-307-HC	18"	16"	3"	Hood Corbel
BB-407-HC	18"	16"	4-3/4"	Hood Corbel

Bar Brackets

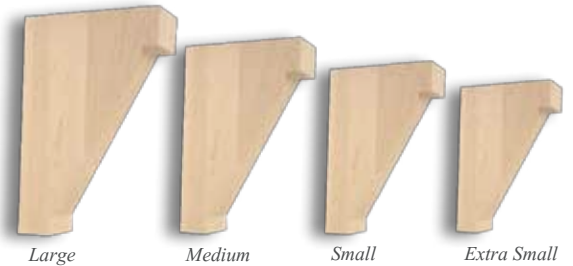

	Item No.	Tall	Deep	Wide	Description
1-3/4" W	BB-007-L	12"	8"	1-3/4"	Large
	BB-007-M	9"	6-1/2"	1-3/4"	Medium
	BB-007-S	7-1/2"	5"	1-3/4"	Small
	BB-007-XS	6"	4"	1-3/4"	Extra Small



Overhang Bracket

Item No.	Tall	Deep	Wide	Description
BB-007-OH	10"	10"	1-3/4"	Overhang
BB-307-OH	10"	10"	3"	Overhang
BB-407-OH	10"	10"	4-3/4"	Overhang

Available in Alder, Cherry, Maple, Poplar, Red Oak & Rubberwood
 Rubberwood not available in 4-3/4"
 Other Species available upon request

3" W	BB-307-L	12"	8"	3"	Large
	BB-307-M	9"	6-1/2"	3"	Medium
	BB-307-S	7-1/2"	5"	3"	Small
	BB-307-XS	6"	4"	3"	Extra Small

4-3/4" W	BB-407-L	12"	8"	4-3/4"	Large
	BB-407-M	9"	6-1/2"	4-3/4"	Medium
	BB-407-S	7-1/2"	5"	4-3/4"	Small
	BB-407-XS	6"	4"	4-3/4"	Extra Small



"Leading the Pack"

BRACKETS & HOOD CORBELS

Corbels, Brackets & Onlays

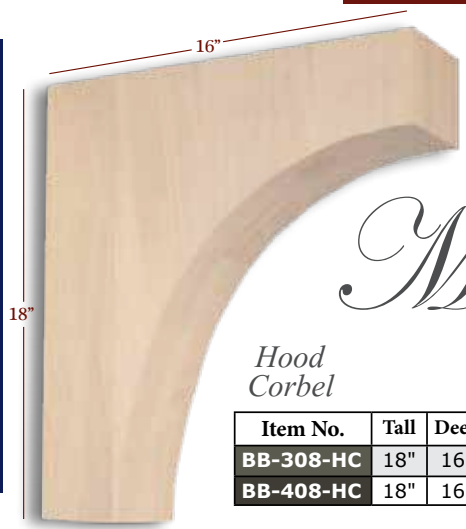

Mission 

Hood Corbel

Item No.	Tall	Deep	Wide	Description
BB-308-HC	18"	16"	3"	Hood Corbel
BB-408-HC	18"	16"	4-3/4"	Hood Corbel

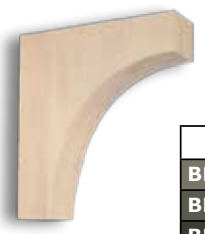

Overhang Bracket

Item No.	Tall	Deep	Wide	Description
BB-008-OH	10"	10"	1-3/4"	Overhang
BB-308-OH	10"	10"	3"	Overhang
BB-408-OH	10"	10"	4-3/4"	Overhang

Available in Alder, Cherry, Maple, Poplar, Red Oak & Rubberwood
 Rubberwood not available in 4-3/4"
 Other Species available upon request

Bar Brackets

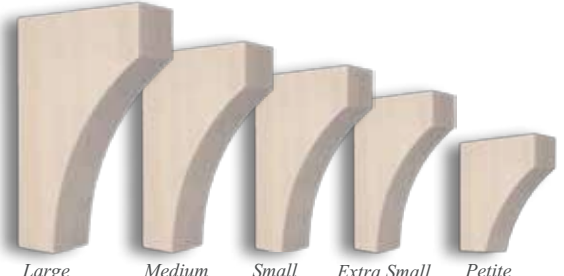

Large Medium Small Extra Small Petite

	Item No.	Tall	Deep	Wide	Description
1-3/4" W	BB-008-L	12"	8"	1-3/4"	Large
	BB-008-M	9"	6-1/2"	1-3/4"	Medium
	BB-008-S	7-1/2"	5"	1-3/4"	Small
	BB-008-XS	6"	4"	1-3/4"	Extra Small
	BB-008-P	3"	3"	1-3/4"	Petite
3" W	BB-308-L	12"	8"	3"	Large
	BB-308-M	9"	6-1/2"	3"	Medium
	BB-308-S	7-1/2"	5"	3"	Small
	BB-308-XS	6"	4"	3"	Extra Small
	BB-308-P	3"	3"	3"	Petite
4-3/4" W	BB-408-L	12"	8"	4-3/4"	Large
	BB-408-M	9"	6-1/2"	4-3/4"	Medium
	BB-408-S	7-1/2"	5"	4-3/4"	Small
	BB-408-XS	6"	4"	4-3/4"	Extra Small
	BB-408-P	3"	3"	4-3/4"	Petite

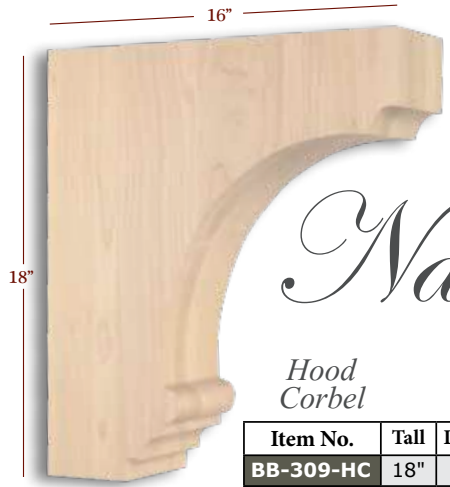

Nantucket 

Hood Corbel

Item No.	Tall	Deep	Wide	Description
BB-309-HC	18"	16"	3"	Hood Corbel
BB-409-HC	18"	16"	4-3/4"	Hood Corbel



Overhang Bracket

Item No.	Tall	Deep	Wide	Description
BB-009-OH	10"	10"	1-3/4"	Overhang
BB-309-OH	10"	10"	3"	Overhang
BB-409-OH	10"	10"	4-3/4"	Overhang

Available in Alder, Cherry, Maple, Poplar, Red Oak & Rubberwood
 Rubberwood not available in 4-3/4"
 Other Species available upon request

Bar Brackets

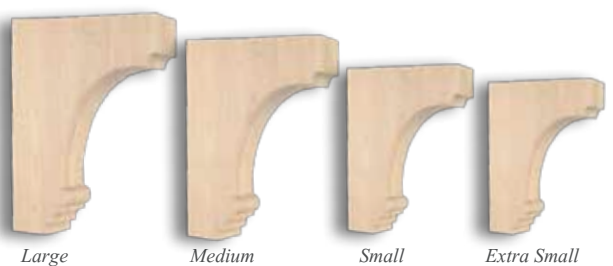

Large Medium Small Extra Small

	Item No.	Tall	Deep	Wide	Description
1-3/4" W	BB-009-L	12"	8"	1-3/4"	Large
	BB-009-M	9"	6-1/2"	1-3/4"	Medium
	BB-009-S	7-1/2"	5"	1-3/4"	Small
	BB-009-XS	6"	4"	1-3/4"	Extra Small
3" W	BB-309-L	12"	8"	3"	Large
	BB-309-M	9"	6-1/2"	3"	Medium
	BB-309-S	7-1/2"	5"	3"	Small
	BB-309-XS	6"	4"	3"	Extra Small
4-3/4" W	BB-409-L	12"	8"	4-3/4"	Large
	BB-409-M	9"	6-1/2"	4-3/4"	Medium
	BB-409-S	7-1/2"	5"	4-3/4"	Small
	BB-409-XS	6"	4"	4-3/4"	Extra Small

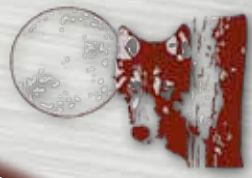

BRACKETS & HOOD CORBELS



Manchester

Hood Corbel

Item No.	Tall	Deep	Wide	Description
BB-310-HC	18"	16"	3"	Hood Corbel
BB-410-HC	18"	16"	4-3/4"	Hood Corbel

Bar Brackets



Large Medium Small Extra Small Petite

	Item No.	Tall	Deep	Wide	Description
1-3/4" W	BB-010-L	12"	8"	1-3/4"	Large
	BB-010-M	9"	6-1/2"	1-3/4"	Medium
	BB-010-S	7-1/2"	5"	1-3/4"	Small
	BB-010-XS	6"	4"	1-3/4"	Extra Small
	BB-010-P	3"	3"	1-3/4"	Petite
3" W	BB-310-L	12"	8"	3"	Large
	BB-310-M	9"	6-1/2"	3"	Medium
	BB-310-S	7-1/2"	5"	3"	Small
	BB-310-XS	6"	4"	3"	Extra Small
	BB-310-P	3"	3"	3"	Petite
4-3/4" W	BB-410-L	12"	8"	4-3/4"	Large
	BB-410-M	9"	6-1/2"	4-3/4"	Medium
	BB-410-S	7-1/2"	5"	4-3/4"	Small
	BB-410-XS	6"	4"	4-3/4"	Extra Small
	BB-410-P	3"	3"	4-3/4"	Petite



Overhang Bracket

Available in Alder, Cherry, Maple, Poplar, Red Oak & Rubberwood
 Rubberwood not available in 4-3/4"
 Other Species available upon request

Item No.	Tall	Deep	Wide	Description
BB-010-OH	10"	10"	1-3/4"	Overhang
BB-310-OH	10"	10"	3"	Overhang
BB-410-OH	10"	10"	4-3/4"	Overhang



Massive Hood Corbel

Available in Maple only
 Other Species upon request

Rockefeller

Item No.	Tall	Deep	Wide	Description
BB-611-MHC	26"	19"	6"	Massive Hood Corbel

Design-A-Corbel...

Need it Taller, Wider or Deeper? We realize that everyone's ideas and needs are not the same. If you have another design or need special dimensions, please call us for a Custom Quote.



Corbels, Brackets & Onlays



"Leading the Pack"

TRIM TO HEIGHT HOOD, ISLAND & MANTEL CORBELS

Corbels, Brackets & Onlays

Trim to Fit Corbels Designer TIP...

These Trim to Fit corbels are designed for use with 21" to 24" deep range hoods. They are also great for a corbel/post load bearing application for islands, overhangs and peninsulas. You may even consider them as support for a mantel.

Other sizes available upon request. Standard stocking species is maple. Any other species, please call for lead time and pricing.

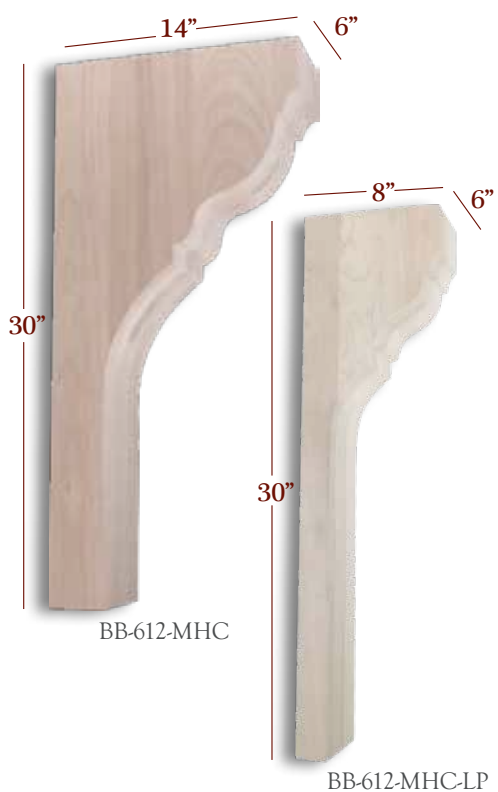

Houston 🇺🇸

Plain 🇺🇸

Item No.	Tall	Deep	Wide	Description
BB-612-MHC	30"	14"	6"	Massive Hood Corbel
BB-612-MHC-LP	30"	8"	6"	Massive Hood Corbel - Low Profile
BB-401-TC	36"	16"	4-3/4"	Trim to Fit Corbel

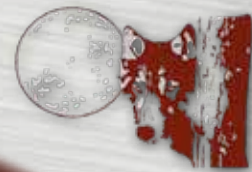

TRIM TO HEIGHT HOOD, ISLAND & MANTEL CORBELS

Corbels, Brackets & Onlays

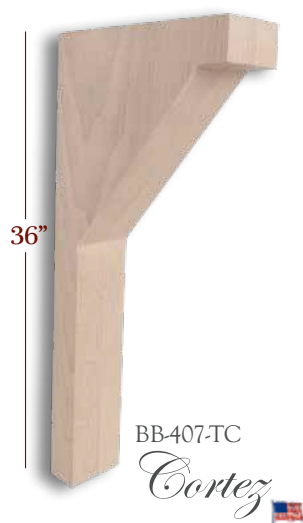

Item No.	Tall	Deep	Wide	Description
BB-402-TC	36"	16"	4-3/4"	SCALLOPED SERIES - Trim to Fit Corbel
BB-403-TC	36"	16"	4-3/4"	COVE SERIES - Trim to Fit Corbel
BB-404-TC	36"	16"	4-3/4"	LEXINGTON SERIES - Trim to Fit Corbel
BB-405-TC	36"	16"	4-3/4"	PROVIDENCE - Trim to Fit Corbel
BB-407-TC	36"	16"	4-3/4"	CORTEZ - Trim to Fit Corbel
BB-408-TC	36"	16"	4-3/4"	MISSION - Trim to Fit Corbel
BB-409-TC	36"	16"	4-3/4"	NANTUCKET - Trim to Fit Corbel
BB-410-TC	36"	16"	4-3/4"	MANCHESTER - Trim to Fit Corbel

"Leading the Pack"

CORBELS

Acanthus

Corbels, Brackets & Onlays

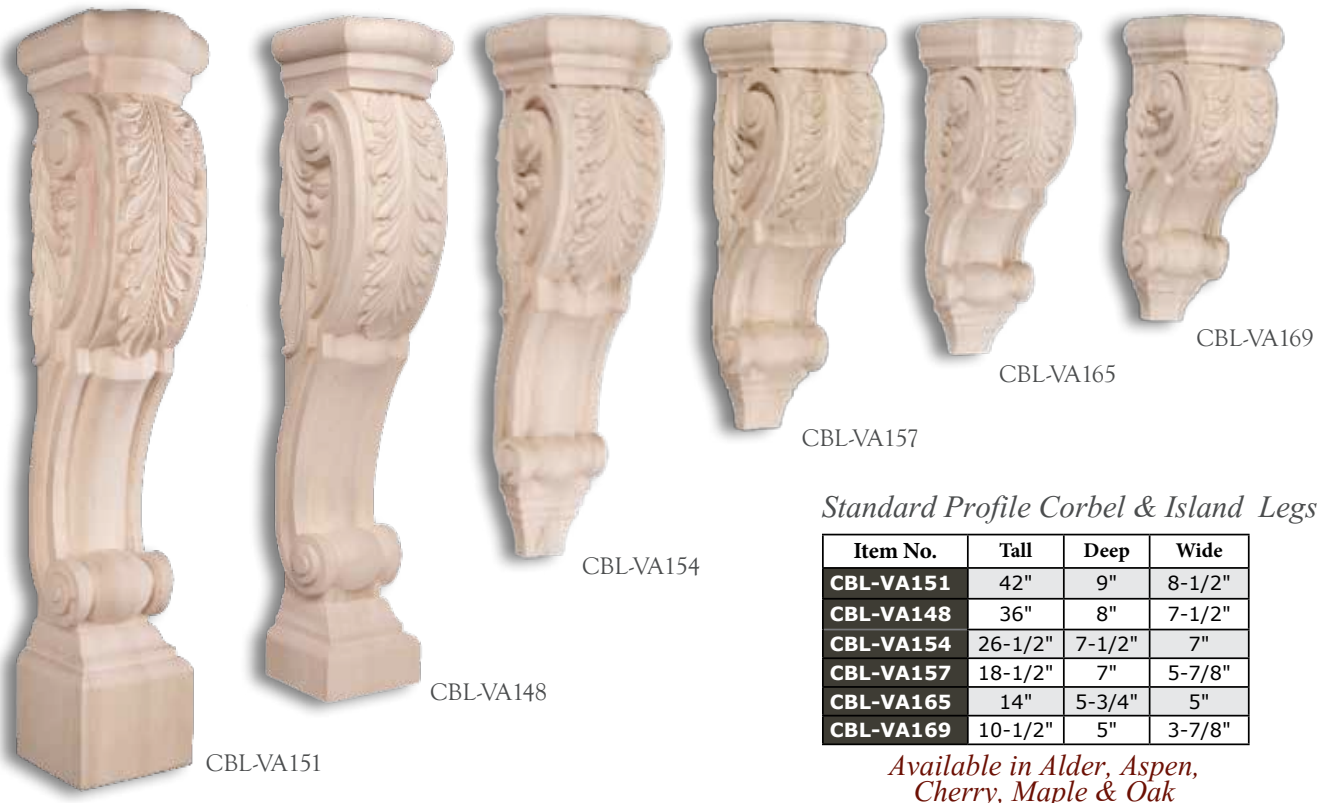

Standard Profile Corbel & Island Legs

Item No.	Tall	Deep	Wide
CBL-VA151	42"	9"	8-1/2"
CBL-VA148	36"	8"	7-1/2"
CBL-VA154	26-1/2"	7-1/2"	7"
CBL-VA157	18-1/2"	7"	5-7/8"
CBL-VA165	14"	5-3/4"	5"
CBL-VA169	10-1/2"	5"	3-7/8"

Available in Alder, Aspen, Cherry, Maple & Oak

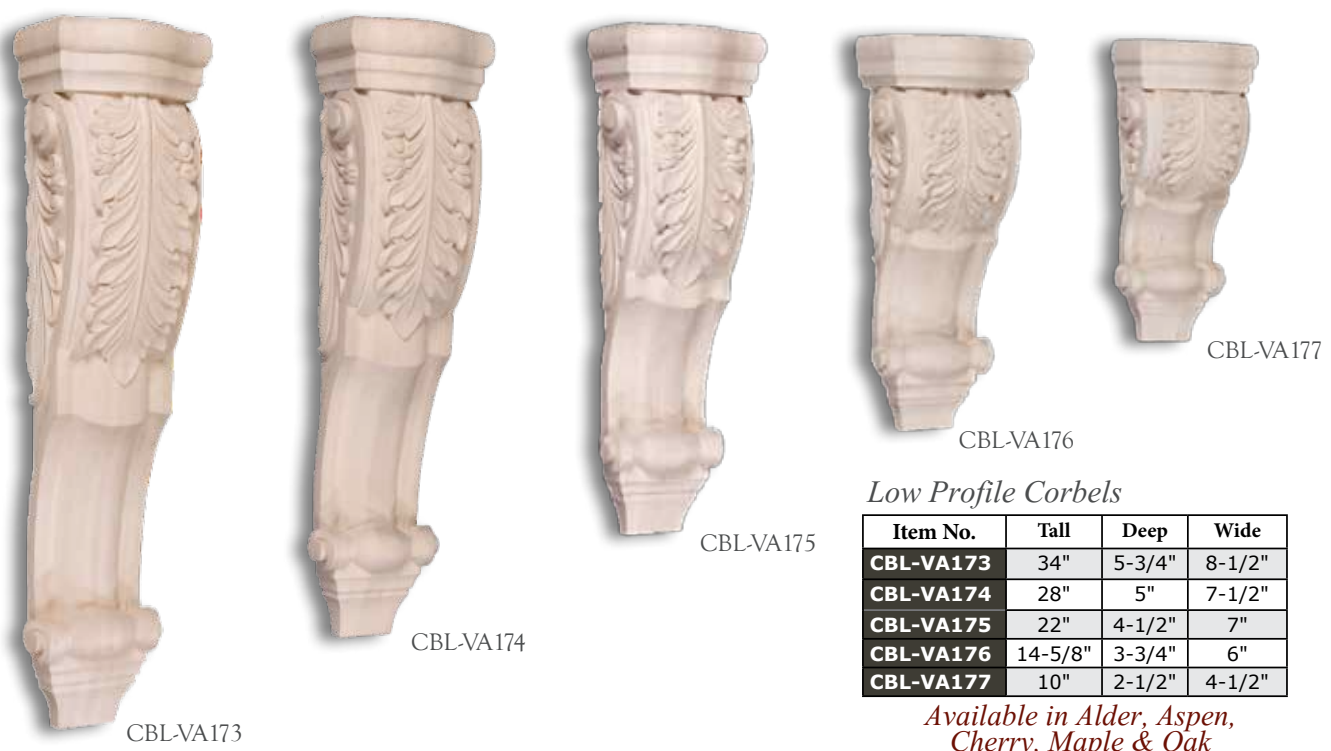

Low Profile Corbels

Item No.	Tall	Deep	Wide
CBL-VA173	34"	5-3/4"	8-1/2"
CBL-VA174	28"	5"	7-1/2"
CBL-VA175	22"	4-1/2"	7"
CBL-VA176	14-5/8"	3-3/4"	6"
CBL-VA177	10"	2-1/2"	4-1/2"

Available in Alder, Aspen, Cherry, Maple & Oak

Phone: 877-504-WOLF
(9653)
sales@TimberWolfForest.com

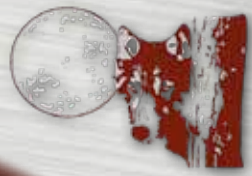

CORBELS

Acanthus

Corbels, Brackets & Onlays



CBL-PA3



CBL-PA2



CBL-PA1



CBL-PA4

Standard Profile Corbels

Item No.	Tall	Deep	Wide
CBL-PA1	10"	5-1/4"	4-5/8"
CBL-PA2	14"	7"	5"
CBL-PA3	22"	7-3/4"	6-3/4"

Available in Alder, Cherry, Maple, Red Oak & Rubberwood

Standard Profile Corbels

Item No.	Tall	Deep	Wide
CBL-PA4	13"	7-3/4"	3-1/2"

Available in Alder, Cherry, Maple, Red Oak & Rubberwood



CBL-PA7



CBL-PA6



CBL-PA5



CBL-PA11



CBL-PA10



CBL-PA9



CBL-PA8

Low Profile Corbels

Item No.	Tall	Deep	Wide
CBL-PA5	6"	1-3/8"	2-3/4"
CBL-PA6	8"	1-1/2"	3-1/2"
CBL-PA7	10"	1-3/4"	4-1/2"

Available in Alder, Cherry, Maple, Red Oak & Rubberwood

Low Profile Corbels

Item No.	Tall	Deep	Wide
CBL-PA8	4-1/4"	1-3/4"	3"
CBL-PA9	4-1/2"	1-1/2"	2-3/4"
CBL-PA10	5-1/2"	1-1/4"	3-1/2"
CBL-PA11	7"	2"	4-1/2"

Available in Alder, Cherry, Maple, Red Oak & Rubberwood



CBL-WC10

Standard Profile Corbels

Item No.	Tall	Deep	Wide
CBL-WC10	14"	7-5/16"	5"

Available in Rubberwood Only



CBL-WC14

Standard Profile Corbels

Item No.	Tall	Deep	Wide
CBL-WC14	13"	9"	2-1/2"

Available in Rubberwood Only

"Leading the Pack"

CORBELS

Mission

Corbels, Brackets & Onlays



CBL-PM2

CBL-PM1

Item No.	Tall	Deep	Wide
CBL-PM1	8"	5"	2"
CBL-PM2	12"	9"	3"

Available in Alder, Cherry, Maple, Red Oak & Rubberwood



CBL-WC22

Item No.	Tall	Deep	Wide
CBL-WC22	14"	6"	3"

Available in Alder, Cherry, Maple, Red Oak & Rubberwood



CBL-PM4

Item No.	Tall	Deep	Wide
CBL-PM4	12"	6-1/2"	2-1/2"

Available in Alder, Cherry, Maple, Red Oak & Rubberwood



CBL-004-XL

CBL-004-L

CBL-004-M

CBL-004-S

CBL-004-XS

Item No.	Tall	Deep	Wide
CBL-004-XL	22"	12"	4-3/4"
CBL-004-L	14"	8-1/2"	3"
CBL-004-M	10"	6"	3"
CBL-004-S	7-1/2"	4-1/2"	3"
CBL-004-XS	5"	3"	3"

Available in Alder, Cherry, Maple, Poplar, Red Oak & Rubberwood
Other Species upon request

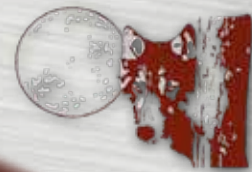

CORBELS

Mission

Corbels, Brackets & Onlays



CBL-VM430



CBL-VM429



CBL-VM428



CBL-VM427



CBL-VM426



CBL-40-XL



CBL-40-L



CBL-40-M



CBL-40-S



CBL-40-XS

Item No.	Tall	Deep	Wide
CBL-VM430	36"	8"	8"
CBL-VM429	26-1/2"	7"	7"
CBL-VM428	18-1/2"	5-3/4"	5-3/4"
CBL-VM427	14"	5"	5"
CBL-VM426	10-1/2"	4"	4"

Available in Alder, Aspen, Cherry, Maple & Oak

Item No.	Tall	Deep	Wide
CBL-40-XL	22"	5-1/2"	8-1/2"
CBL-40-L	12"	5"	8"
CBL-40-M	9"	4-1/2"	6-1/2"
CBL-40-S	6"	2-1/2"	5-1/4"
CBL-40-XS	4"	1-7/8"	4"

Available in Alder, Cherry, Maple, Poplar, Red Oak & Rubberwood
Other Species upon request



CBL-PM10



CBL-PM9



CBL-PM8



CBL-PM7



CBL-PM6



CBL-PM5

Item No.	Tall	Deep	Wide
CBL-PM8	7-1/2"	5"	4-1/2"
CBL-PM9	10-5/8"	7"	5"
CBL-PM10	16-15/16"	7-5/8"	6-3/4"

Available in Alder, Cherry, Maple, Red Oak & Rubberwood

Item No.	Tall	Deep	Wide
CBL-PM5	10"	5"	4-1/2"
CBL-PM6	14"	7"	5"
CBL-PM7	22"	7-5/8"	6-3/4"

Available in Alder, Cherry, Maple, Red Oak & Rubberwood

"Leading the Pack"

CORBELS

Traditional

Corbels, Brackets & Onlays

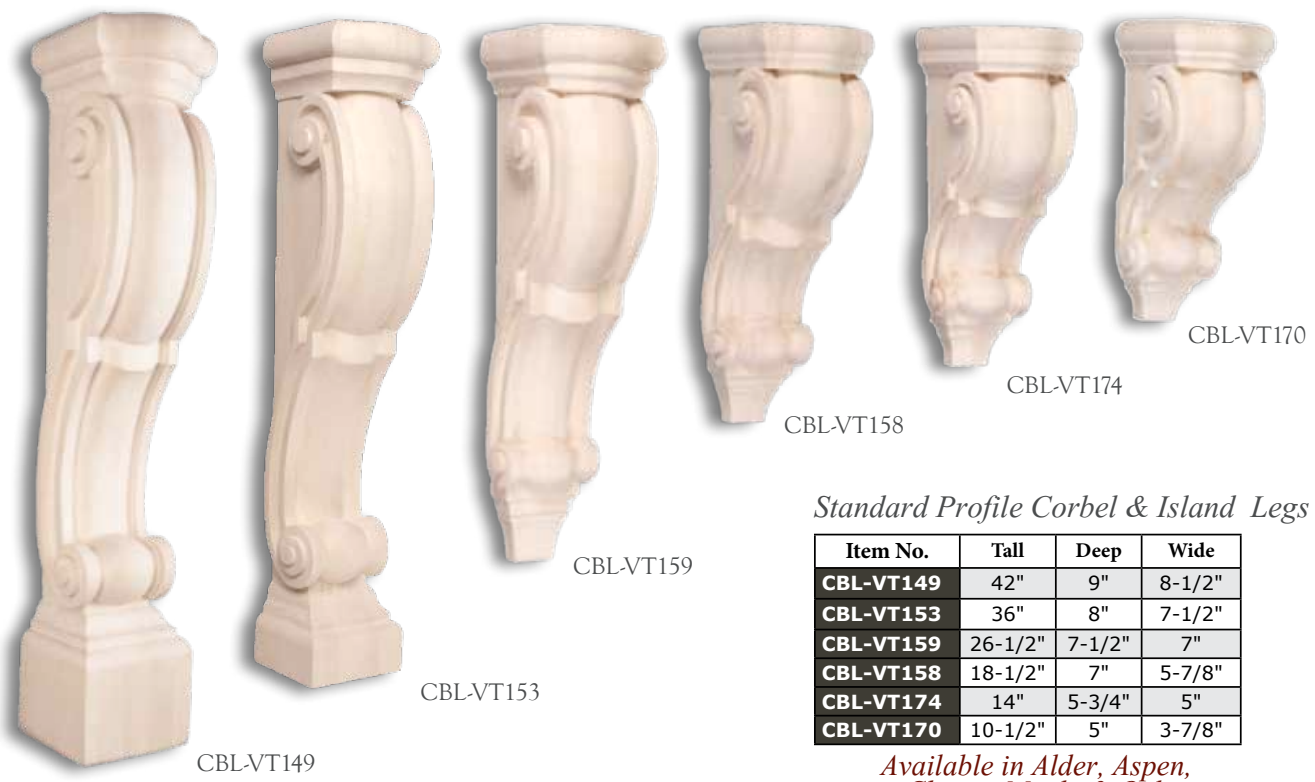

Standard Profile Corbel & Island Legs

Item No.	Tall	Deep	Wide
CBL-VT149	42"	9"	8-1/2"
CBL-VT153	36"	8"	7-1/2"
CBL-VT159	26-1/2"	7-1/2"	7"
CBL-VT158	18-1/2"	7"	5-7/8"
CBL-VT174	14"	5-3/4"	5"
CBL-VT170	10-1/2"	5"	3-7/8"

Available in Alder, Aspen, Cherry, Maple & Oak

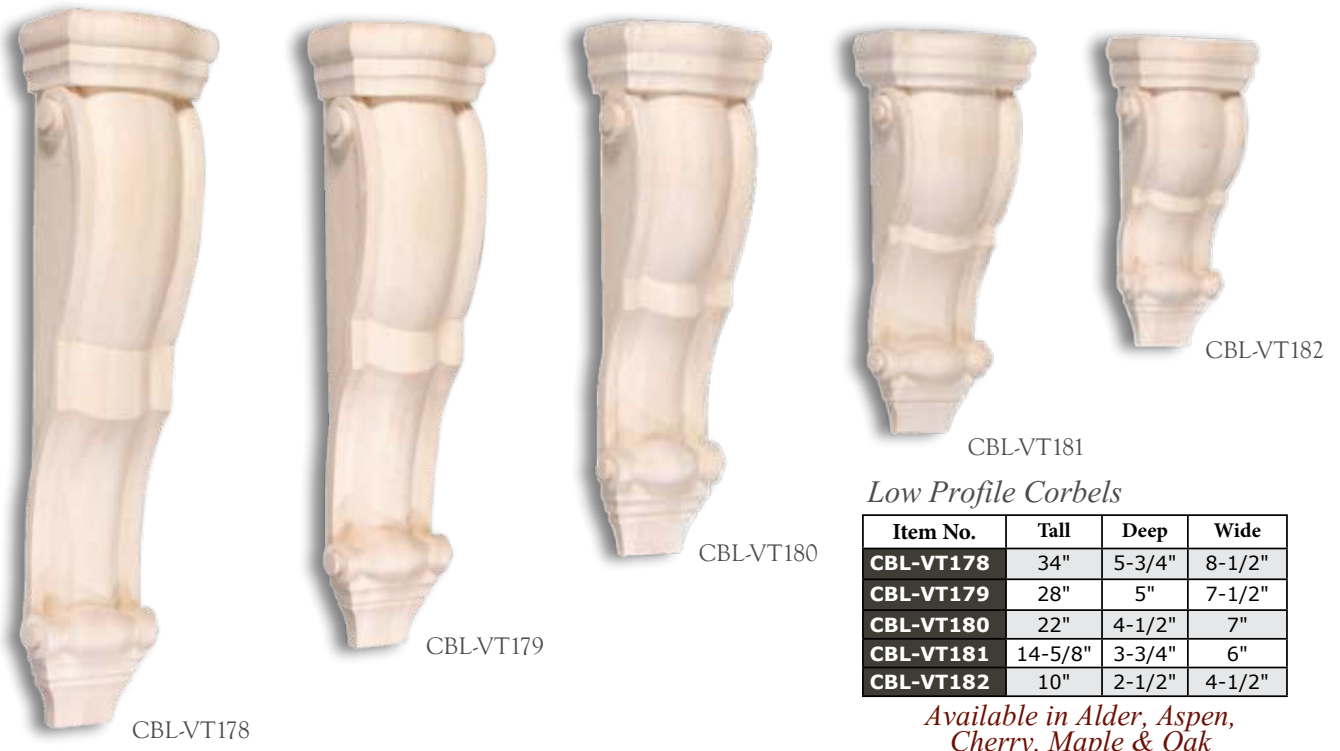

Low Profile Corbels

Item No.	Tall	Deep	Wide
CBL-VT178	34"	5-3/4"	8-1/2"
CBL-VT179	28"	5"	7-1/2"
CBL-VT180	22"	4-1/2"	7"
CBL-VT181	14-5/8"	3-3/4"	6"
CBL-VT182	10"	2-1/2"	4-1/2"

Available in Alder, Aspen, Cherry, Maple & Oak

Phone: 877-504-WOLF
(9653)
sales@TimberWolfForest.com

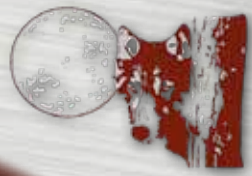

CORBELS

Traditional

Corbels, Brackets & Onlays



Item No.	Tall	Deep	Wide
CBL-PT1	10"	5-1/4"	4-1/2"
CBL-PT2	14"	7"	5"
CBL-PT3	22"	7-5/8"	6-3/4"

Available in Alder, Cherry, Maple, Red Oak & Rubberwood



Item No.	Tall	Deep	Wide
CBL-PT4	13"	7-3/4"	3-3/8"

Available in Alder, Cherry, Maple, Red Oak & Rubberwood



Item No.	Tall	Deep	Wide
CBL-PT5	4-1/4"	1-3/4"	2-7/8"

Available in Alder, Cherry, Maple, Red Oak & Rubberwood



Item No.	Tall	Deep	Wide
CBL-001-S	6-3/4"	3-3/4"	3-1/2"
CBL-001-M	10"	5"	5"
CBL-001-L	14"	7"	5-1/4"

*Available in Alder, Cherry, Maple, Poplar & Red Oak
CBL-001-S also available in Rubberwood*



Item No.	Description	Tall	Deep	Wide
CBL-WC12	Plain	12"	6-1/2"	3"
CBL-WC12-4.5	Plain	12"	6-1/2"	4-1/2"
CBL-WC12-5.75	Plain	12"	6-1/2"	5-3/4"
CBL-WC12F	Fluted	12"	6-1/2"	3"

Available in Alder, Cherry, Maple, Red Oak & Rubberwood



Item No.	Tall	Deep	Wide
CBL-WC13	9-3/4"	5-5/8"	4-1/2"

Available in Rubberwood Only

"Leading the Pack"

CORBELS

Transitional

Corbels, Brackets & Onlays



Maverick
CBL-002-M

Item No.	Tall	Deep	Wide
CBL-002-M	10-1/16"	6"	3-1/2"

Available in Alder, Cherry, Maple, Poplar & Red Oak
Other Species upon request



Vita
CBL-003-M

Item No.	Tall	Deep	Wide
CBL-003-M	10"	6-7/16"	3"

Available in Alder, Cherry, Maple, Poplar & Red Oak
Other Species upon request



Cape Cod
CBL-006-M

Item No.	Tall	Deep	Wide
CBL-006-M	10"	6-3/8"	3"

Available in Alder, Cherry, Maple, Poplar & Red Oak
Other Species upon request



Hudson
CBL-007-M

Item No.	Tall	Deep	Wide
CBL-007-M	10"	6"	3"

Available in Alder, Cherry, Maple, Poplar & Red Oak
Other Species upon request



Eastwood
CBL-008-M

Item No.	Tall	Deep	Wide
CBL-008-M	10"	6"	3"

Available in Alder, Cherry, Maple, Poplar & Red Oak
Other Species upon request



Transitional
CBL-WC16

Item No.	Tall	Deep	Wide
CBL-WC16	10-1/2"	7-1/2"	2"

Available in Alder, Cherry, Maple, Poplar & Rubberwood
Other Species upon request

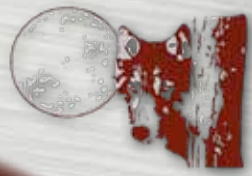

APPLIQUES & CAPITALS

Corbels, Brackets & Onlays



Applique
CRV-VR071



Applique
CRV-VR072



Applique
CRV-VR097



Applique
CRV-VR099



Capital
CRV-VC344



Capital
CRV-VC343



Applique
CRV-VR587



Applique
CRV-VR588



Capital
CRV-VC262



Capital
CRV-VC260



Applique
CRV-VR562-L



Applique
CRV-VR562-M



Capital
CRV-VC261

Item No.	Tall	Deep	Wide
CRV-VR071	2-1/4"	3/8"	2-1/4"
CRV-VR072	3-1/8"	3/8"	3-1/8"
CRV-VR097	3-1/2"	3/4"	3-1/2"
CRV-VR099	3-1/2"	3/4"	3-1/2"
CRV-VC260	3"	7/8"	3"
CRV-VC261	6"	7/8"	6"
CRV-VC262	8"	15/16"	8"
CRV-VC343	4"	1-5/8"	3-1/2"
CRV-VC344	5-1/4"	2"	4-3/4"
CRV-VR562-S	4-3/8"	5/8"	2-3/4"
CRV-VR562-M	6-1/2"	7/8"	4-1/8"
CRV-VR562-L	10-3/4"	7/8"	6-5/8"
CRV-VR587	5"	1/2"	5"
CRV-VR588	5"	1/2"	5"

Available in Aspen, Alder,
Cherry, Maple, & Oak



Applique
CRV-VR562-S

"Leading the Pack"

ONLAYS

Corbels, Brackets & Onlays



Onlay
ONL-1S-20



Onlay
ONL-1M-24



Onlay
ONL-1L-36

Item No.	Tall	Deep	Wide
ONL-1L-36	7-1/2"	7/8"	36"
ONL-1M-24	5"	3/4"	24"
ONL-1S-20	4"	3/4"	20"

*Available in Alder,
Cherry, Maple, Red
Oak & Rubberwood*



Onlay
ONL-2S-20



Onlay
ONL-2M-24



Onlay
ONL-2L-36

Item No.	Tall	Deep	Wide
ONL-2L-36	7-1/2"	7/8"	36"
ONL-2M-24	5"	3/4"	24"
ONL-2S-20	4-1/4"	3/4"	20"

*Available in Alder,
Cherry, Maple, Red
Oak & Rubberwood*

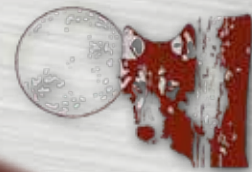

ONLAYS & PLINTH BLOCKS

Corbels, Brackets & Onlays



Onlay
ONL-V182*



Onlay
ONL-V156*

Item No.	Tall	Deep	Wide
ONL-V156	4-1/4"	7/16"	17-5/8"
ONL-V182	2-3/4"	5/8"	7-1/2"

*Available in Poplar,
Maple, & Oak*

** Sold as a pair - measurements given are per piece*



Rosette
TW-R8

Item No.	Tall	Deep	Wide
TW-R8	3-3/4"	1"	3-3/4"

*Available in Alder, Cherry, Maple,
Red Oak & Rubberwood*



Plinth Block
TW-PB9

Item No.	Tall	Deep	Wide
TW-PB9	7"	1"	3-3/4"

*Available in Alder, Cherry, Maple,
Red Oak & Rubberwood*

"Leading the Pack"

36" & 42" LEGS & POSTS



ISL2500F
Shown in Picture

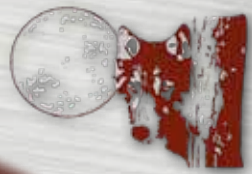

36" & 42" LEGS & POSTS DESIGN INDEX

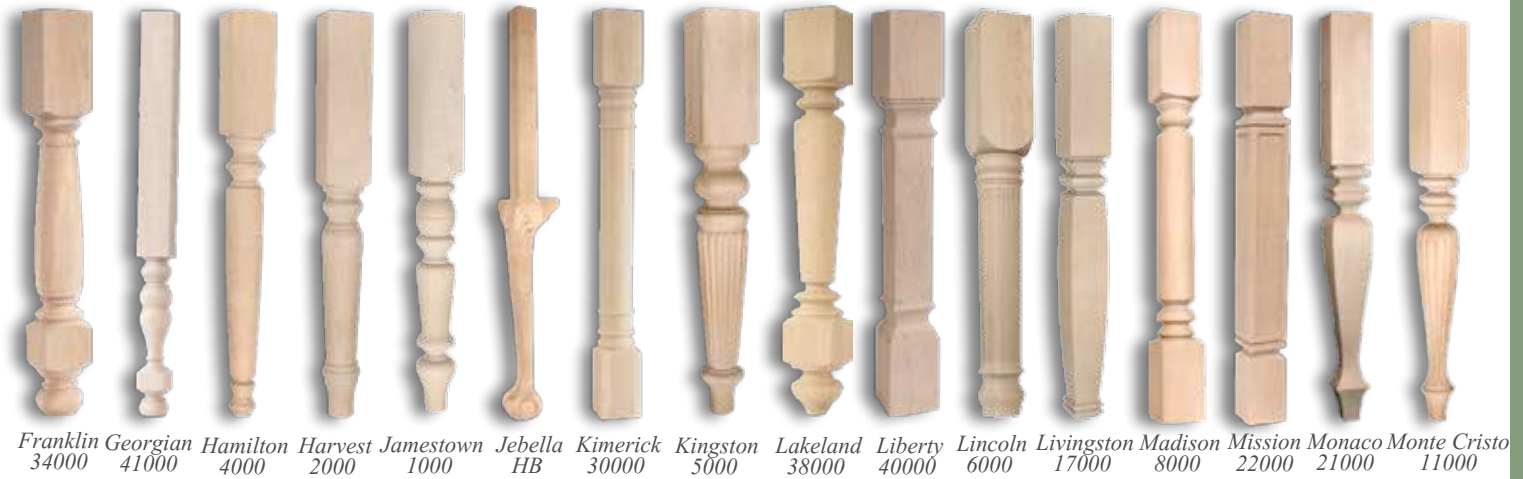

"Leading the Pack"

ACANTHUS

BELLINGTON

Fluted Acanthus

Plain Round

36" & 42" Posts & Legs



ISL31500FA

Available in Alder, Cherry, Maple, Red Oak & Rubberwood



ISL24300P



ISL24350P



ISL24375P



ISL24500P

Available in Alder, Cherry, Maple, Poplar, Red Oak & Rubberwood
Other Species upon request

Item No.	Tall	Width	Top Shank Length	Bottom Shank Length
ISL31500FA	36"	5"	7-11/16"	7-11/16"
ISL24300P	36"	3"	6"	6"
ISL24350P	36"	3-1/2"	6"	6"
ISL24375P	36"	3-3/4"	6"	6"
ISL24500P	36"	5"	6"	6"



Find a matching
Bun Foot on
pages 14

American Made

BF913 Phone: 877-504-WOLF
(9653)
sales@TimberWolfForest.com

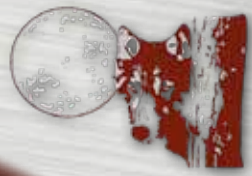

BRANSON

Plain Square



ISL8300CP



ISL8375CP



ISL8500CP



BAR8375CP

36" & 42" Posts & Legs

* Branson Series available in 36" & 42" tall & 3", 3-1/2", 3-3/4" & 5" sq.



BF928-C



BF929-C

Find a matching
Bun Foot on
page 15

Item No.	Description	Tall	Width	Top Shank Length	Bottom Shank Length
ISL8300CP	3" sq. x 36" PLAIN SQUARE	36"	3"	8"	6-3/4"
ISL8350CP	3-1/2" sq. x 36" PLAIN SQUARE	36"	3-1/2"	8"	6-3/4"
ISL8375CP	3-3/4" sq. x 36" PLAIN SQUARE	36"	3-3/4"	8"	6-3/4"
ISL8500CP	5" sq. x 36" PLAIN SQUARE	36"	5"	8"	6-3/4"
BAR8300CP	3" sq. x 42" PLAIN SQUARE	42"	3"	8"	6-3/4"
BAR8350CP	3-1/2" sq. x 42" PLAIN SQUARE	42"	3-1/2"	8"	6-3/4"
BAR8375CP	3-3/4" sq. x 42" PLAIN SQUARE	42"	3-3/4"	8"	6-3/4"
BAR8500CP	5" sq. x 42" PLAIN SQUARE	42"	5"	8"	6-3/4"

Available in Alder, Cherry, Maple,
Red Oak & Rubberwood
Other Species upon request



"Leading the Pack"

BRANSON ✱

Fluted Square



ISL8375CF
Shown in Picture

36" & 42" Posts & Legs



ISL8300CF



ISL8375CF

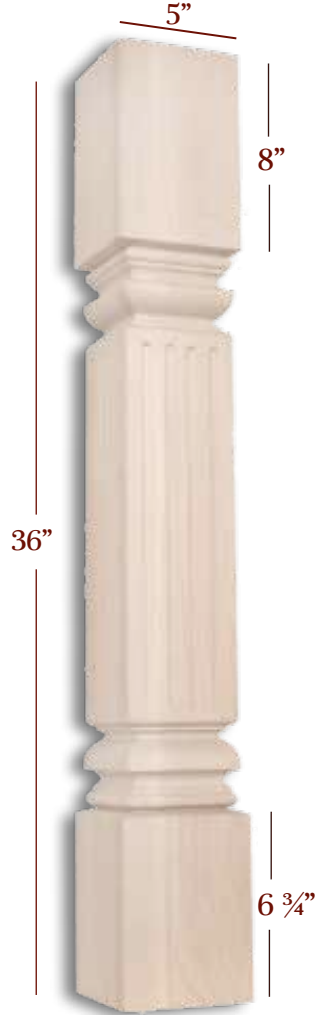

ISL8500CF

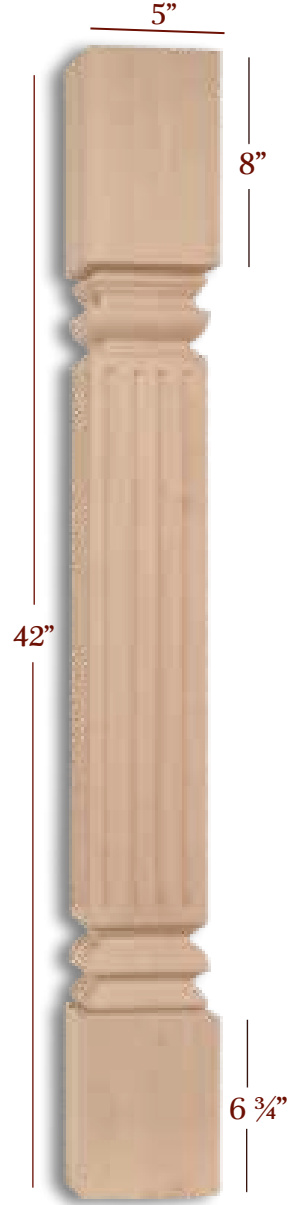

BAR8500CF

✱ *Branson Series available in 36" & 42" tall & 3", 3-1/2", 3-3/4" & 5" sq.*



ISL8500CF, BAR8500CP
BAR8500CF & ISL8500CP
Shown in Picture

Item No.	Description	Tall	Width	Top Shank Length	Bottom Shank Length
ISL8300CF	3" sq. x 36" FLUTED SQUARE	36"	3"	8"	6-3/4"
ISL8350CF	3-1/2" sq. x 36" FLUTED SQUARE	36"	3-1/2"	8"	6-3/4"
ISL8375CF	3-3/4" sq. x 36" FLUTED SQUARE	36"	3-3/4"	8"	6-3/4"
ISL8500CF	5" sq. x 36" FLUTED SQUARE	36"	5"	8"	6-3/4"
BAR8300CF	3" sq. x 42" FLUTED SQUARE	42"	3"	8"	6-3/4"
BAR8350CF	3-1/2" sq. x 42" FLUTED SQUARE	42"	3-1/2"	8"	6-3/4"
BAR8375CF	3-3/4" sq. x 42" FLUTED SQUARE	42"	3-3/4"	8"	6-3/4"
BAR8500CF	5" sq. x 42" FLUTED SQUARE	42"	5"	8"	6-3/4"

Available in Alder, Cherry, Maple,
Red Oak & Rubberwood
Other Species upon request



American Made



Phone: 877-504-WOLF
(9 6 5 3)
sales@TimberWolfForest.com

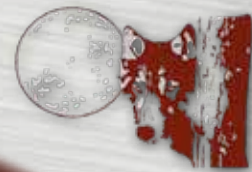

CABRIOLE

Plain



CAB350
Shown in Picture

36" & 42" Posts & Legs



CAB300-36



CAB350-36



CAB300-6

*Find a matching
Bun Foot on
pages 156 & 184*

*Available in Alder, Cherry, Maple,
Poplar, Red Oak, & Rubberwood
Other Species upon request*

Item No.	Tall	Width	Top Shank Length	Toe
CAB300-36	36"	3"	11-1/2"	1-3/8"
CAB350-36	36"	3-1/2"	8"	1-1/2"

** Cabriole Series is also available in 6", 18" & 29"
See Page 14, 156 & 158*

"Leading the Pack"

CATHEDRAL

CORNER POSTS

Available in Alder, Cherry, Maple, Poplar, Red Oak & Rubberwood
 HB1000 not available in Poplar
 Other Species upon request

QUEEN ANNE STYLE ROUND FACE SQUARE FACE
 Fluted Plain Plain Fluted Plain Fluted Plain

36" & 42" Posts & Legs



CP-QATF-36 CP-QATP-36 HB1000 CP-RTF-36 CP-RTP-36 CP-STF-36 CP-STP-36

Cathedral Series Posts Available in 32", 36" & 42" Tall

CP-QATF-36 & CP-QATP-36 Post Top End View

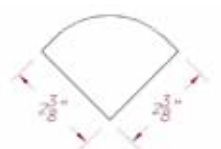

HB1000 Post Top End View

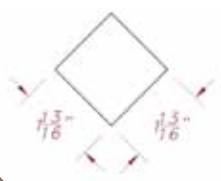

Round Face Corner Post Top End View



Square Face Corner Post Top End View



Item No.	Desc.	Tall	Width	Top Shank Length	Bottom Shank Length	Toe
CP-QATF-36	Fluted	36"	2-3/8"	4"	N/A	1-3/4"
CP-QATP-36	Plain	36"	2-3/8"	4"	N/A	1-3/4"
CP-RTF-32	Fluted	32"	2-3/8"	4"	4"	N/A
CP-RTF-36	Fluted	36"	2-3/8"	4"	4"	N/A
CP-RTF-42	Fluted	42"	2-3/8"	4"	4"	N/A
CP-RTP-32	Plain	32"	2-3/8"	4"	4"	N/A
CP-RTP-36	Plain	36"	2-3/8"	4"	4"	N/A
CP-RTP-42	Plain	42"	2-3/8"	4"	4"	N/A
CP-STF-32	Fluted	32"	2-3/8"	4"	4"	N/A
CP-STF-36	Fluted	36"	2-3/8"	4"	4"	N/A
CP-STF-42	Fluted	42"	2-3/8"	4"	4"	N/A
CP-STP-32	Plain	32"	2-3/8"	4"	4"	N/A
CP-STP-36	Plain	36"	2-3/8"	4"	4"	N/A
CP-STP-42	Plain	42"	2-3/8"	4"	4"	N/A
HB1000	Plain	42"	1-13/16"	4"	4"	N/A

Phone: 877-504-WOLF
 (9 6 5 3)
 sales@TimberWolfForest.com

American Made

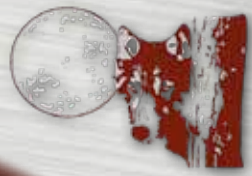

CHARLESTON

Plain Square



36" & 42" Posts & Legs



ISL14275CP

ISL14350CP

ISL14475CP

BAR14275CP

BAR14350CP

BAR14475CP

Available in Alder, Cherry, Maple,
Poplar, Red Oak & Rubberwood
Other Species upon request



BFS14S-C



BF992-C



BFS14L-C



BF993-C

Find a matching
Bun Foot on
pages 14 & 16

Charleston Series Available in 29" Tall - see page 159

Item No.	Tall	Width at Beads	Shank length	Toe	Width of Top
ISL14275CP	36"	2-3/4"	8"	1-7/8"	2-3/8"
ISL14350CP	36"	3-1/2"	8"	2-1/2"	3"
ISL14475CP	36"	4-3/4"	8"	3-7/8"	4-3/8"
BAR14275CP	42"	2-3/4"	13-7/8"	1-7/8"	2-3/8"
BAR14350CP	42"	3-1/2"	13-7/8"	2-1/2"	3"
BAR14475CP	42"	4-3/4"	13-7/8"	3-7/8"	4-3/8"



American Made



"Leading the Pack"

COSMO

Tapered Square

36" & 42" Posts & Legs

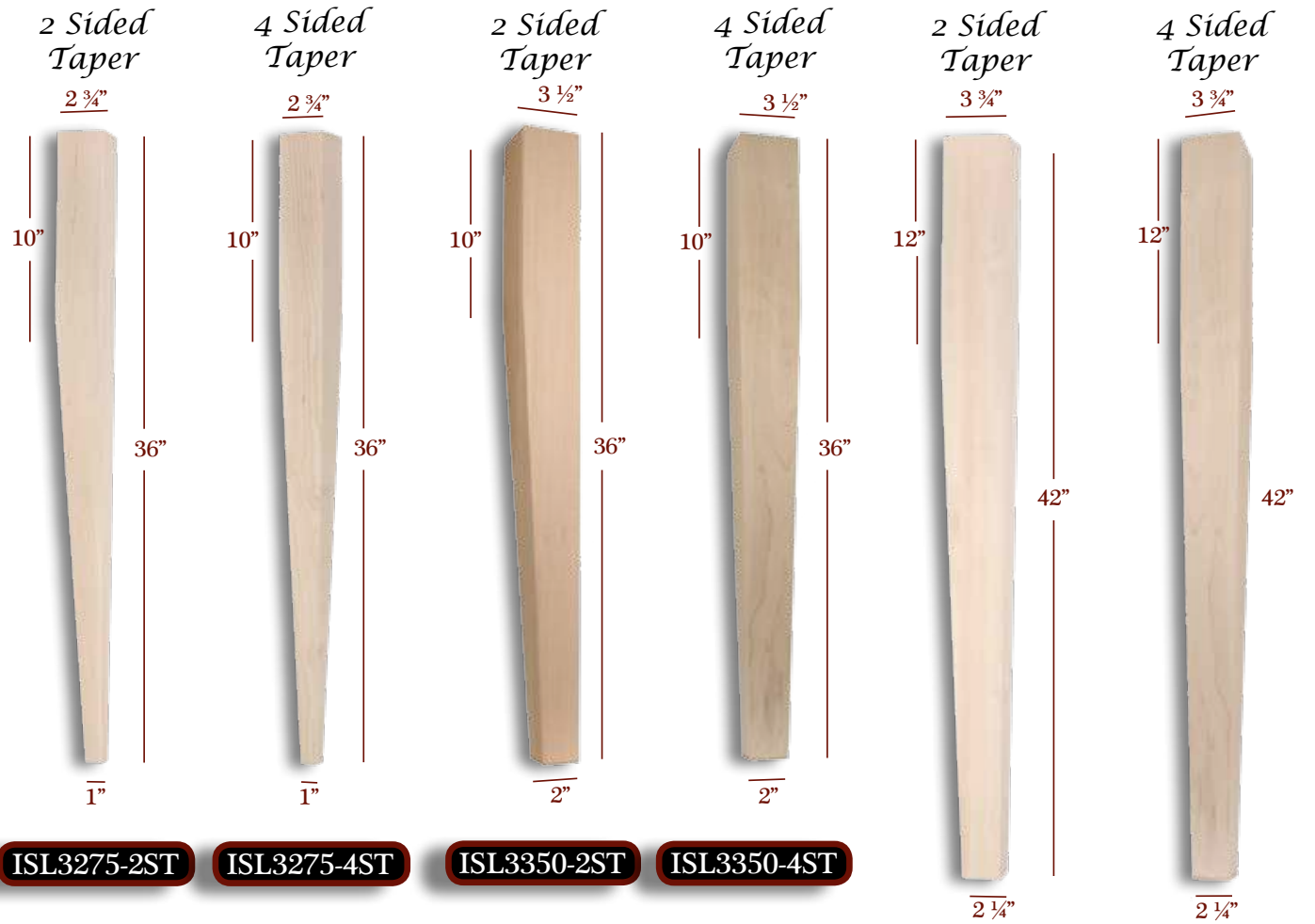

ISL3275-2ST

ISL3275-4ST

ISL3350-2ST

ISL3350-4ST

BAR3375-2ST

BAR3375-4ST

* *Cosmo Series is also available in 18", 21" & 29"*
See Pages 160-162

Item No.	Tall	Width	Top Shank Length	Toe
BAR3350-2ST	42"	3-1/2"	12"	2"
BAR3350-4ST	42"	3-1/2"	12"	2"
BAR3375-2ST	42"	3-3/4"	12"	2-1/4"
BAR3375-4ST	42"	3-3/4"	12"	2-1/4"
ISL3275-2ST	36"	2-3/4"	10"	1"
ISL3275-4ST	36"	2-3/4"	10"	1"
ISL3350-2ST	36"	3-1/2"	10"	2"
ISL3350-4ST	36"	3-1/2"	10"	2"
ISL3375-2ST	36"	3-3/4"	10"	2-1/4"
ISL3375-4ST	36"	3-3/4"	10"	2-1/4"



*Available in Alder, Cherry, Maple,
 Poplar, Red Oak & Rubberwood
 Other Species upon request*

American Made

Phone: 877-504-WOLF
 (9653)
 sales@TimberWolfForest.com

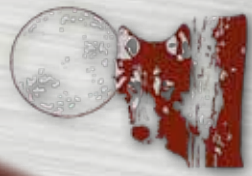

DELLINGER

DILLON

Plain Round

Plain Square

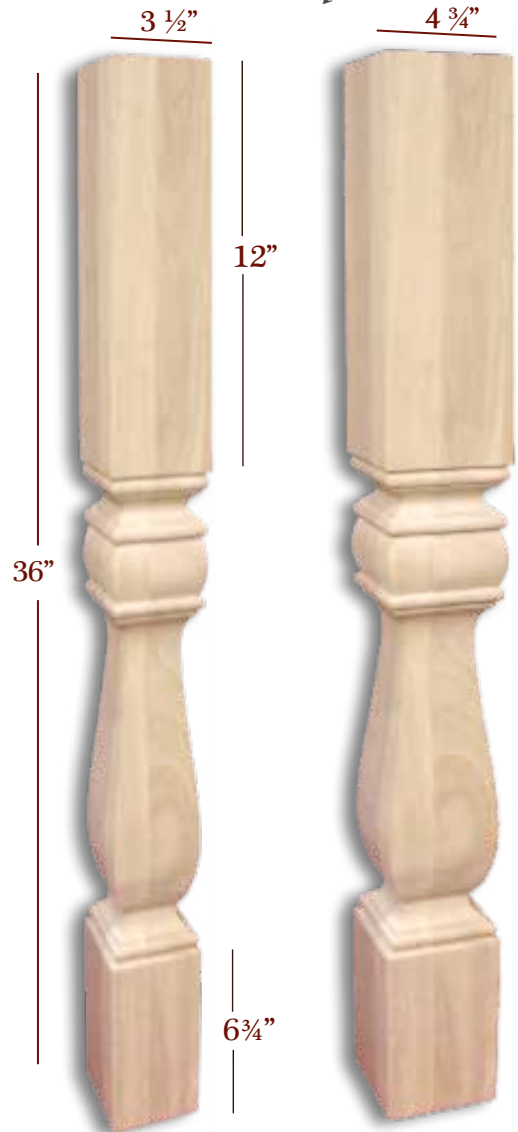
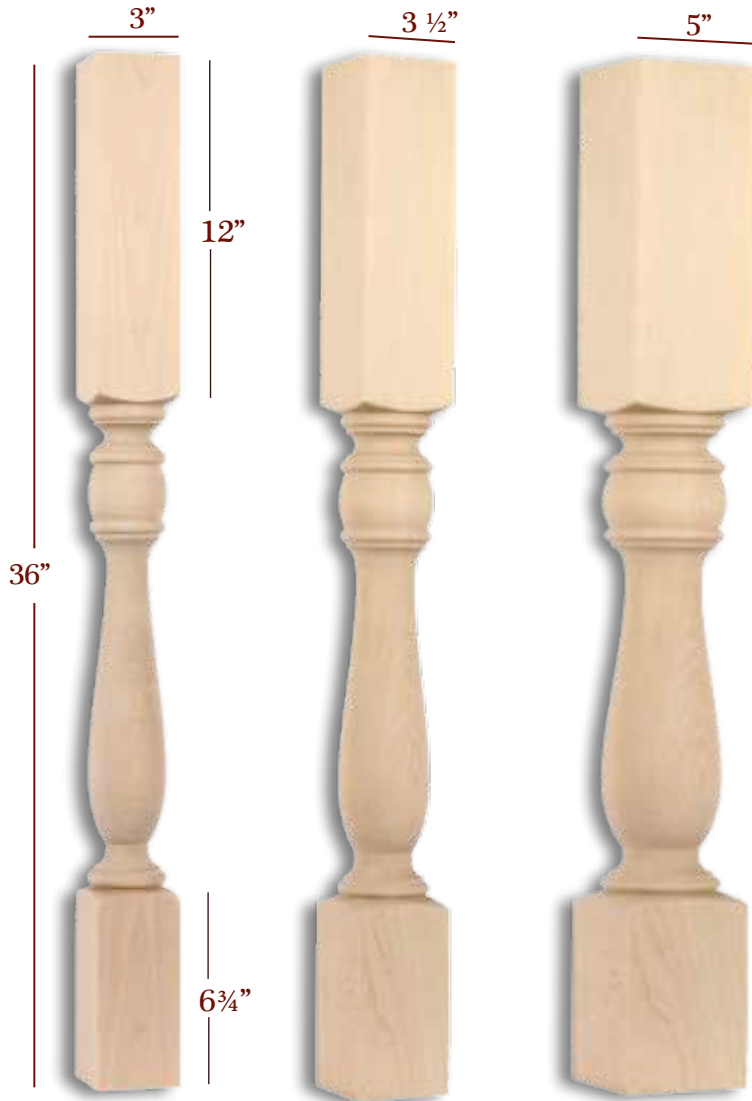

36" & 42" Posts & Legs

ISL10300P

ISL10350P

ISL10500P

ISL27350CP

ISL27475CP

Available in Alder, Cherry, Maple,
Poplar, Red Oak & Rubberwood
Other Species upon request

Available in Alder, Cherry, Maple,
Poplar, Red Oak & Rubberwood
Other Species upon request



BF920-C



BF919

Find a matching
Bun Foot on
page 15

Item No.	Tall	Width	Top Shank Length	Bottom Shank Length
ISL10300P	36"	3"	12"	6-3/4"
ISL10350P	36"	3-1/2"	12"	6-3/4"
ISL10375P	36"	3-3/4"	12"	6-3/4"
ISL10500P	36"	5"	12"	6-3/4"
ISL27350CP	36"	3-1/2"	12"	6-3/4"
ISL27475CP	36"	4-3/4"	12"	6-3/4"

 *Dellinger Series also available in 3 3/4" sq. & 29" tall
see page 163*



"Leading the Pack"

EMPIRE

ELLIS

Plain Round

Reeded Round

Plain Square

36" & 42" Posts & Legs

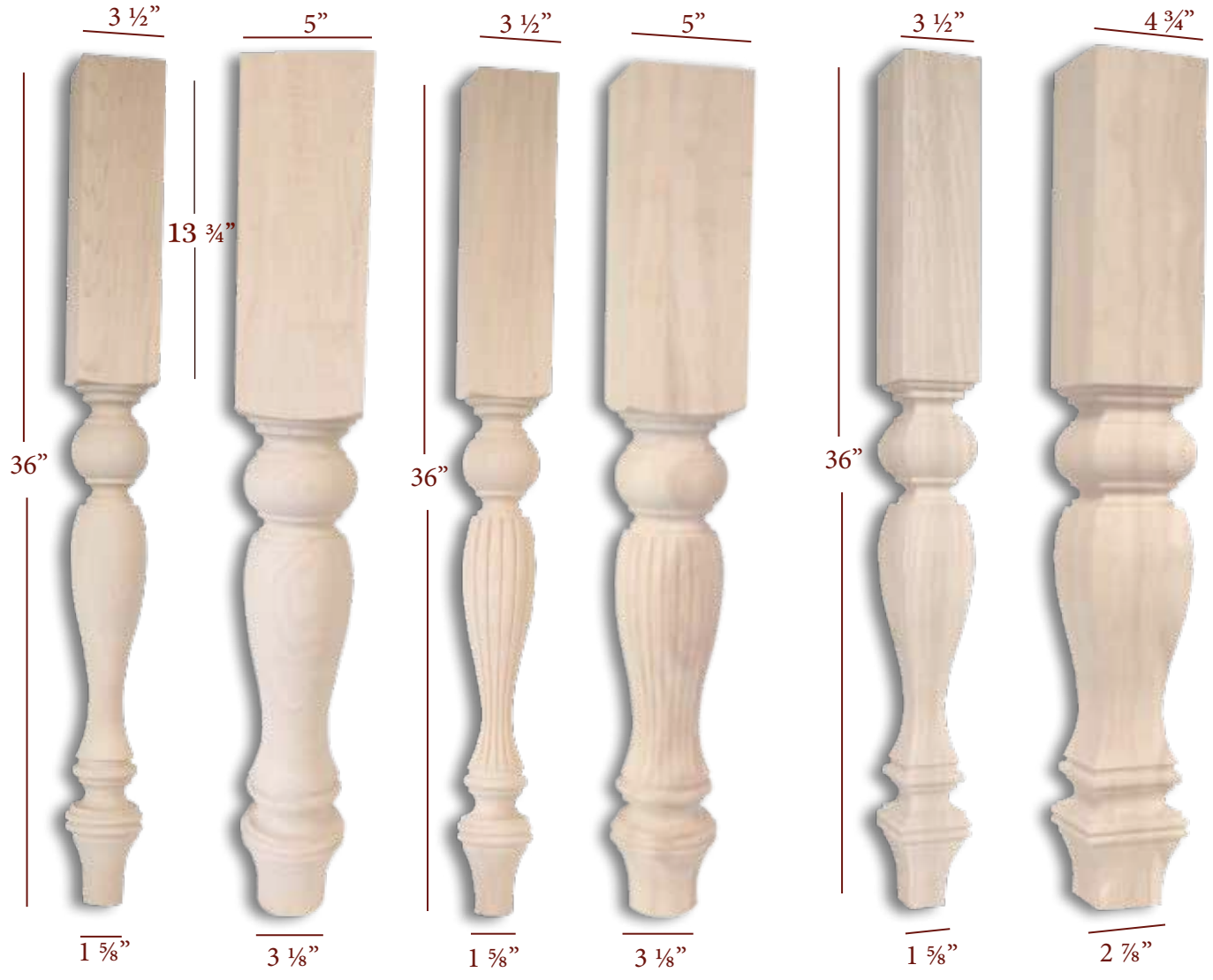

ISL18350P

ISL18500P

ISL18350E

ISL18500E

ISL28350CP

ISL28475CP

Available in Alder, Cherry, Maple, Poplar, Red Oak & Rubberwood
Other Species upon request

Available in Alder, Cherry, Maple, Poplar, Red Oak & Rubberwood
Other Species upon request

Item No.	Tall	Width	Top Shank Length	Toe
ISL18350P	36"	3-1/2"	13-3/4"	1-5/8"
ISL18500P	36"	5"	13-3/4"	3-1/8"
ISL18350E	36"	3-1/2"	13-3/4"	1-5/8"
ISL18500E	36"	5"	13-3/4"	3-1/8"
ISL28350CP	36"	3-1/2"	13-3/4"	1-5/8"
ISL28475CP	36"	4-3/4"	13-3/4"	2-7/8"



Find a matching
Bun Foot on
pages 14 & 15

American Made

Phone: 877-504-WOLF
(9653)
sales@TimberWolfForest.com

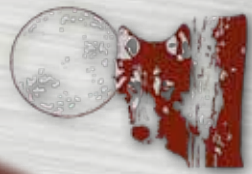

ESSENTIAL

FRANKLIN



36" & 42" Posts & Legs

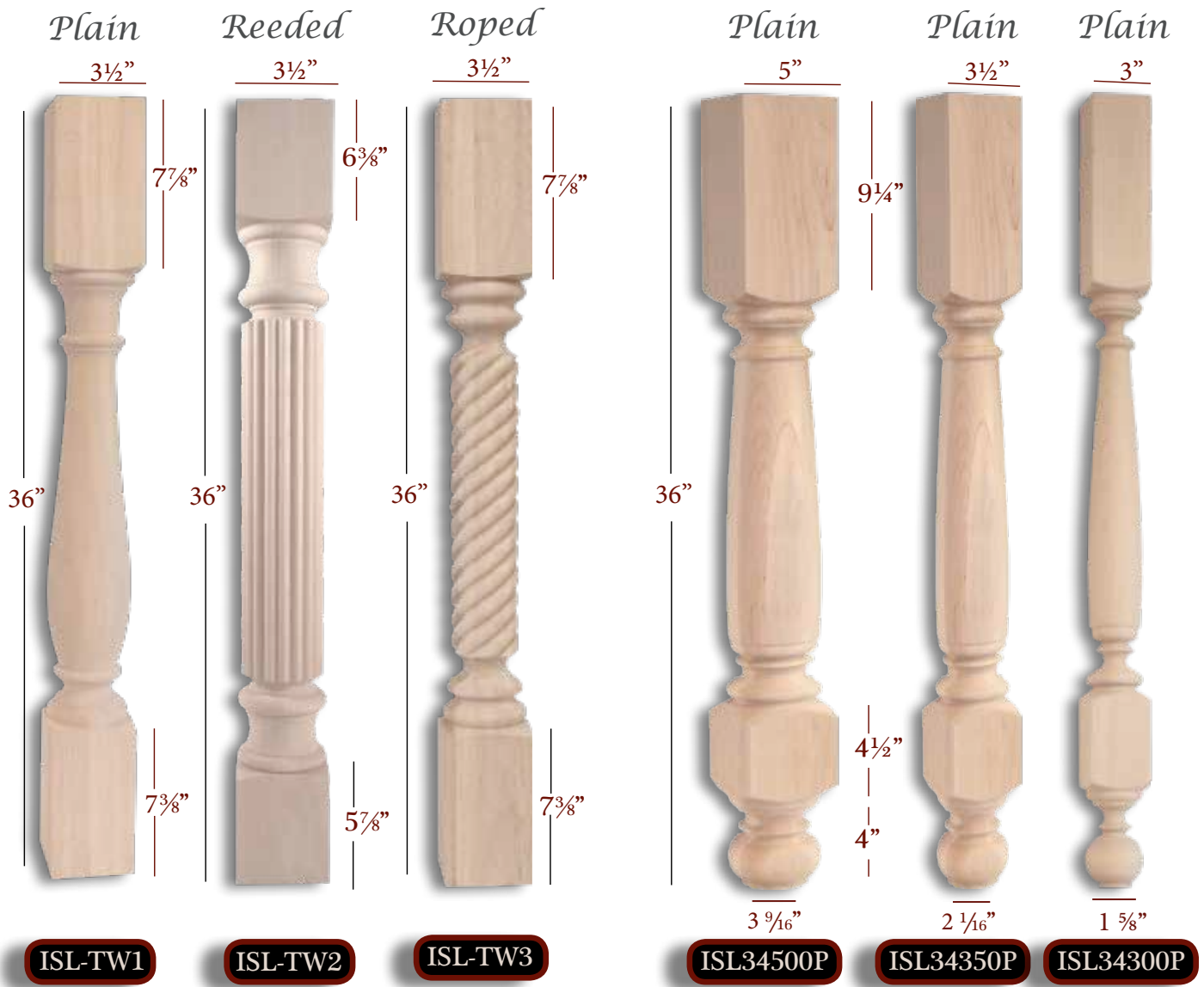

ISL-TW1

ISL-TW2

ISL-TW3

ISL34500P

ISL34350P

ISL34300P

Available in Alder, Cherry, Maple,
Poplar, Red Oak & Rubberwood
Other Species upon request



BF945



BF966

Find a matching
Bun Foot on
page 15

Item No.	Desc.	Tall	Width	Top Shank Length	Bottom Shank Length	Block	Toe
ISL-TW1	Plain	36"	3-1/2"	7-7/8"	7-3/8"	N/A	N/A
ISL-TW1-5	Plain	36"	5"	7-7/8"	7-3/8"	N/A	N/A
ISL-TW2	Reeded	36"	3-1/2"	6-3/8"	5-7/8"	N/A	N/A
ISL-TW3	Roped	36"	3-1/2"	7-7/8"	7-3/8"	N/A	N/A
ISL34500P	Plain	36"	5"	9-1/4"	N/A	4-1/2"	3-9/16"
ISL34350P	Plain	36"	3-1/2"	9-1/4"	N/A	4-1/2"	3-9/16"
ISL34300P	Plain	36"	3"	9-1/4"	N/A	4-1/2"	3-9/16"

✱ Franklin Posts also Available in 3 3/4" sq.

"Leading the Pack"

GEORGIAN

HAMILTON

36" & 42" Posts & Legs

Plain

Plain

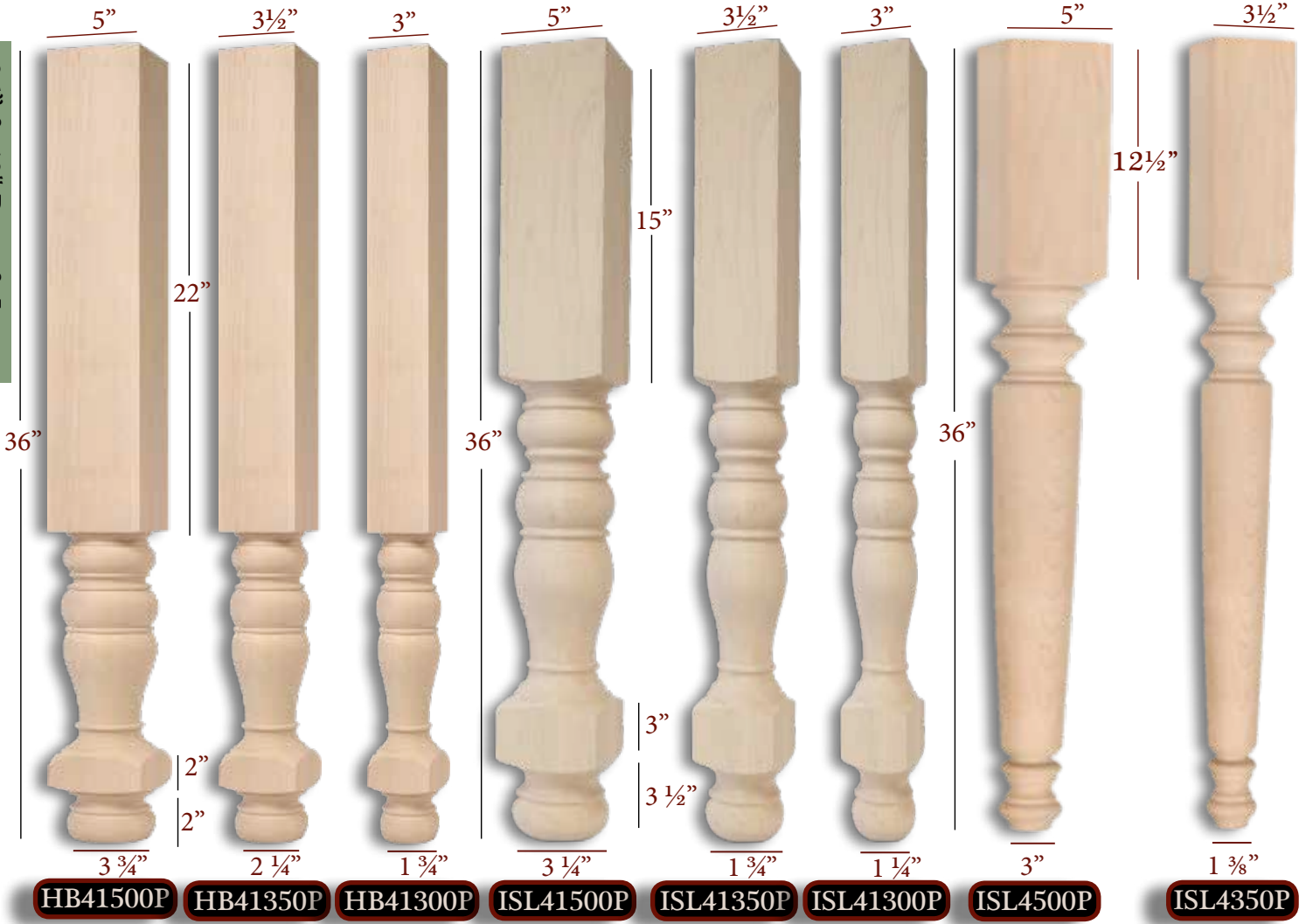

Georgian Legs Available in 2-1/4" x 34-1/2" Vanity Leg - See Page 143

Item No.	Description	Tall	Overall Width	Top Shank Length	Block	Toe
HB41300P	Plain	36"	3"	22"	2"	1-3/4"
HB41350P	Plain	36"	3-1/2"	22"	2"	2-1/4"
HB41500P	Plain	36"	5"	22"	2"	3-3/4"
ISL41300P	Plain	36"	3"	15"	3"	1-1/4"
ISL41350P	Plain	36"	3-1/2"	15"	3"	1-3/4"
ISL41500P	Plain	36"	5"	15"	3"	3-1/4"
ISL4350E	Reeded	36"	3-1/2"	12-1/2"	N/A	1-3/8"
ISL4500E	Reeded	36"	5"	12-1/2"	N/A	3"
ISL4350P	Plain	36"	3-1/2"	12-1/2"	N/A	1-3/8"
ISL4500P	Plain	36"	5"	12-1/2"	N/A	3"
ISL4350R	Roped	36"	3-1/2"	12-1/2"	N/A	1-3/8"
ISL4500R	Roped	36"	5"	12-1/2"	N/A	3"

Hamilton Series Legs also available in Roped & Reeded
Other Sizes available are 18", 21" & 29"
See Pages 164-166

Available in Alder, Cherry, Maple, Poplar, Red Oak & Rubberwood
Other Species upon request

Phone: 877-504-WOLF
(9653)
sales@TimberWolfForest.com



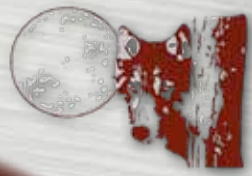

HARVEST *

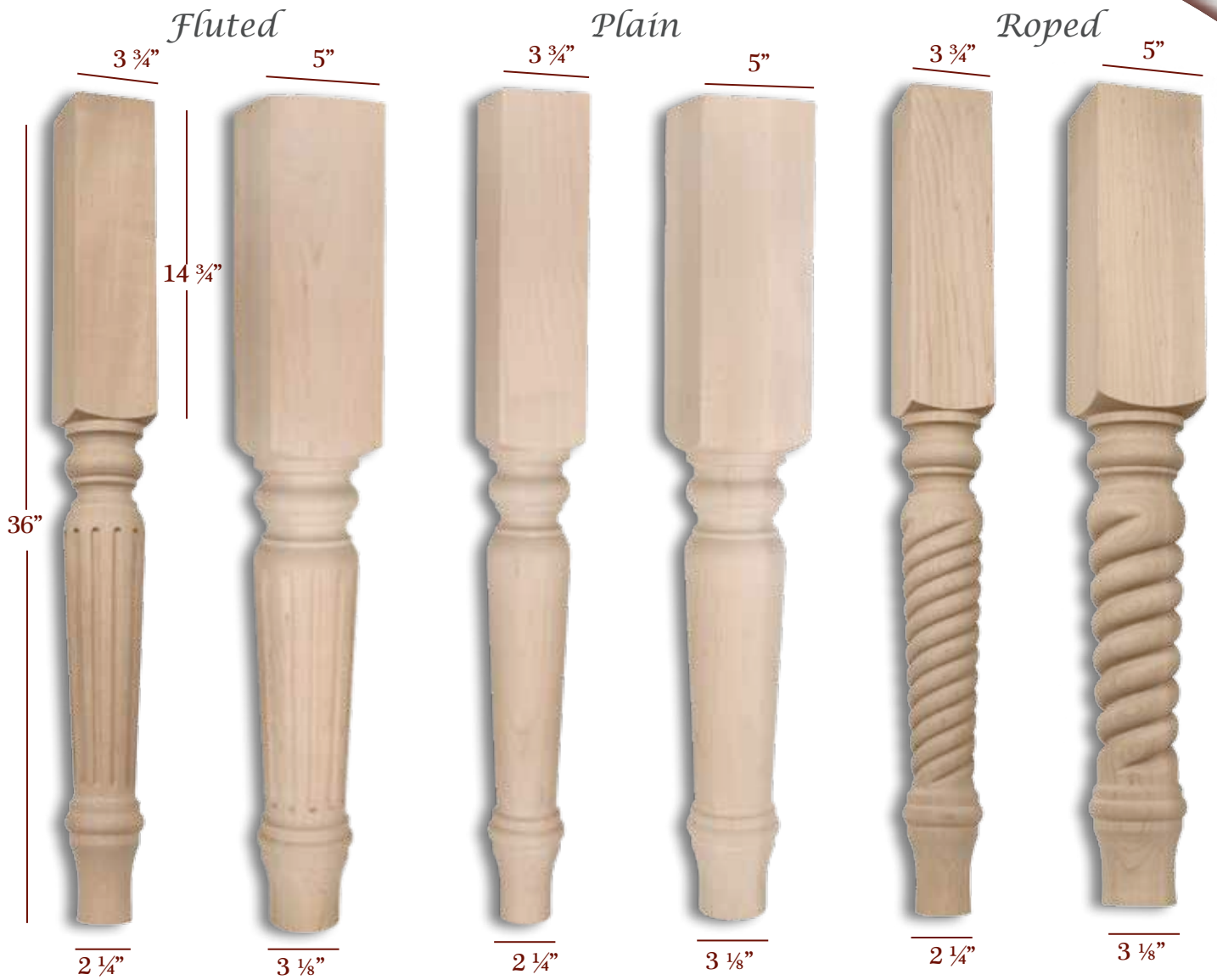

36" & 42" Posts & Legs

ISL2375F

ISL2500F

ISL2375P

ISL2500P

ISL2375R

ISL2500R

*Available in Alder, Cherry, Maple,
Poplar, Red Oak & Rubberwood
Other Species upon request*



Item No.	Tall	Width	Top Shank Length	Toe
ISL2375F	36"	3-3/4"	14-3/4"	2-1/4"
ISL2500F	36"	5"	14-3/4"	3-1/8"
ISL2375P	36"	3-3/4"	14-3/4"	2-1/4"
ISL2500P	36"	5"	14-3/4"	3-1/8"
ISL2375R	36"	3-3/4"	14-3/4"	2-1/4"
ISL2500R	36"	5"	14-3/4"	3-1/8"



BF960



BF963

*Find a matching
Bun Foot on
page 15*

* *Harvest Series is also available in 18", 21" & 29"
See Pages 167-170*

"Leading the Pack"

JAMESTOWN * KIMERICK

36" & 42" Posts & Legs

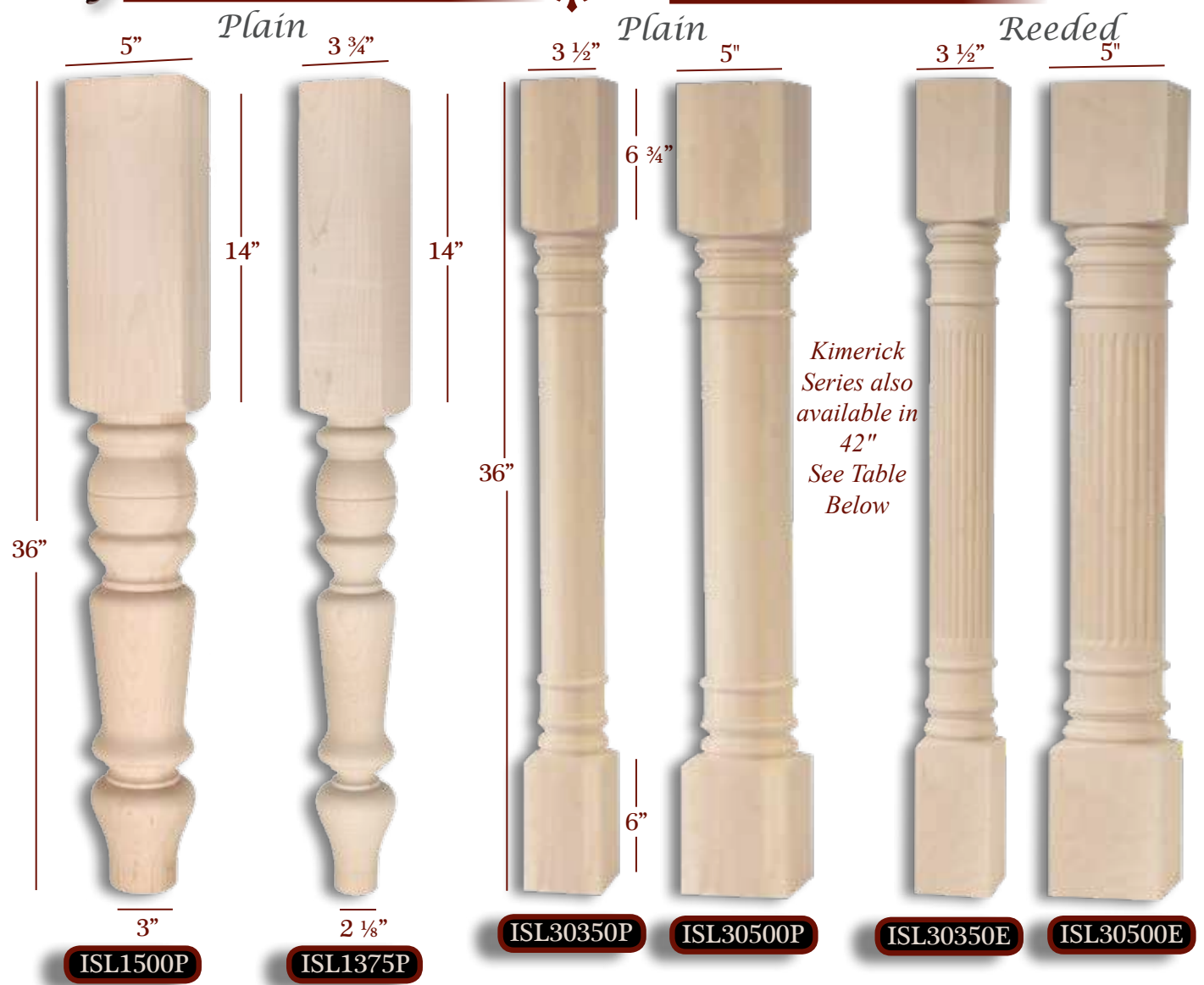

Kimerick Series also available in 42" See Table Below

* *Jamestown Series is also available in 29" See Page 171*



Find a matching Bun Foot on page 15

BF951

Available in Alder, Cherry, Maple, Poplar, Red Oak & Rubberwood Other Species upon request

Item No.	Description	Tall	Width	Top Shank Length	Bottom Shank Length	Toe
ISL1375P	Plain	36"	3-3/4"	14"	N/A	2-1/8"
ISL1500P	Plain	36"	5"	14"	N/A	3"
BAR30300E	Reeded	42"	3"	6-3/4"	6"	N/A
BAR30300P	Plain	42"	3"	6-3/4"	6"	N/A
BAR30350E	Reeded	42"	3-1/2"	6-3/4"	6"	N/A
BAR30350P	Plain	42"	3-1/2"	6-3/4"	6"	N/A
BAR30500E	Reeded	42"	5"	6-3/4"	6"	N/A
BAR30500P	Plain	42"	5"	6-3/4"	6"	N/A
ISL30300E	Reeded	36"	3"	6-3/4"	6"	N/A
ISL30300P	Plain	36"	3"	6-3/4"	6"	N/A
ISL30350E	Reeded	36"	3-1/2"	6-3/4"	6"	N/A
ISL30350P	Plain	36"	3-1/2"	6-3/4"	6"	N/A
ISL30500E	Reeded	36"	5"	6-3/4"	6"	N/A
ISL30500P	Plain	36"	5"	6-3/4"	6"	N/A

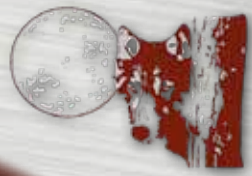

KINGSTON

LAKELAND

Reeded

Plain

Plain

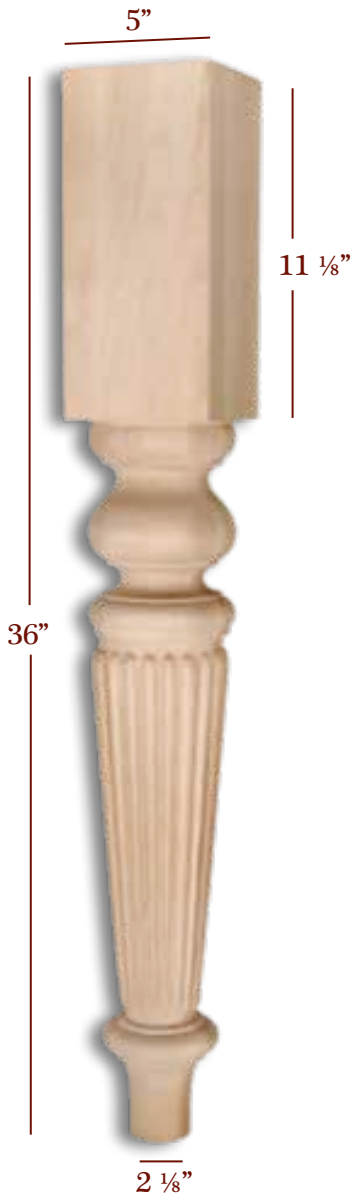

ISL5500E



ISL5500P



ISL38350P



ISL38500P

36" & 42" Posts & Legs

 *Kingston Series is also available in 29"*
See Page 172

*Available in Alder, Cherry, Maple,
 Poplar, Red Oak & Rubberwood
 Other Species upon request*

Item No.	Tall	Width	Top Shank Length	Toe
ISL5500E	36"	5"	11-1/8"	2-1/8"
ISL5500P	36"	5"	11-1/8"	2-1/8"
ISL38350P	36"	3-1/2"	6-1/2"	1-1/4"
ISL38500P	36"	5"	6-1/2"	2-3/4"



"Leading the Pack"

LIBERTY

Plain Square

36" & 42" Posts & Legs

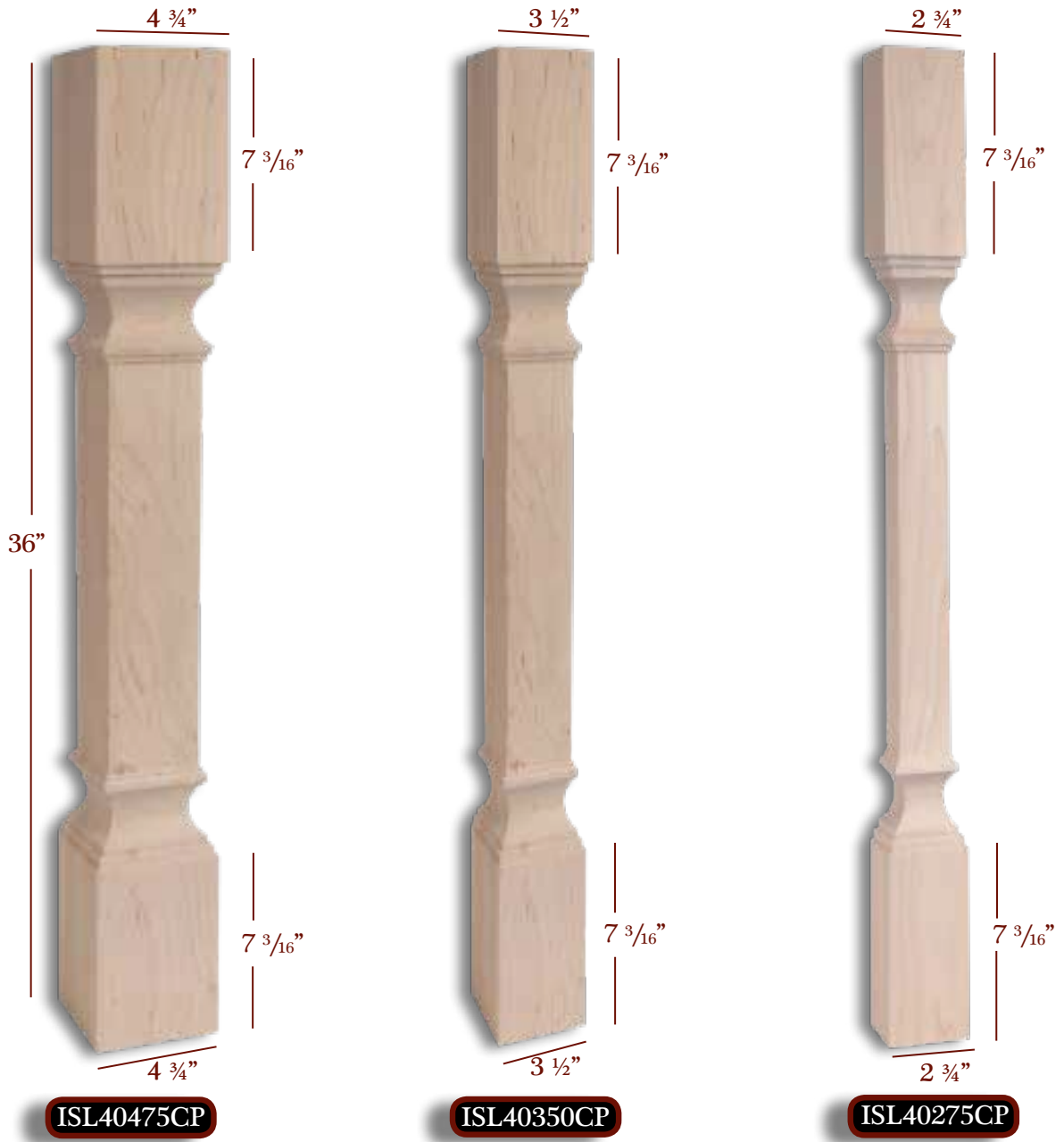

BFS401S

Find a matching
Bun Foot on
page 14

Item No.	Tall	Width	Top Shank Length	Bottom Shank Length
ISL40275CP	36"	2-3/4"	7-3/16"	7-3/16"
ISL40350CP	36"	3-1/2"	7-3/16"	7-3/16"
ISL40475CP	36"	4-3/4"	7-3/16"	7-3/16"



BFS402L

Available in Alder, Cherry, Maple,
Poplar, Red Oak & Rubberwood
Other Species upon request

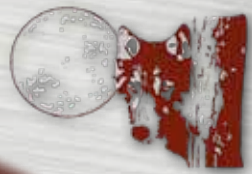

LINCOLN ✱

LIVINGSTON

Plain

Diamond

Reeded

Plain

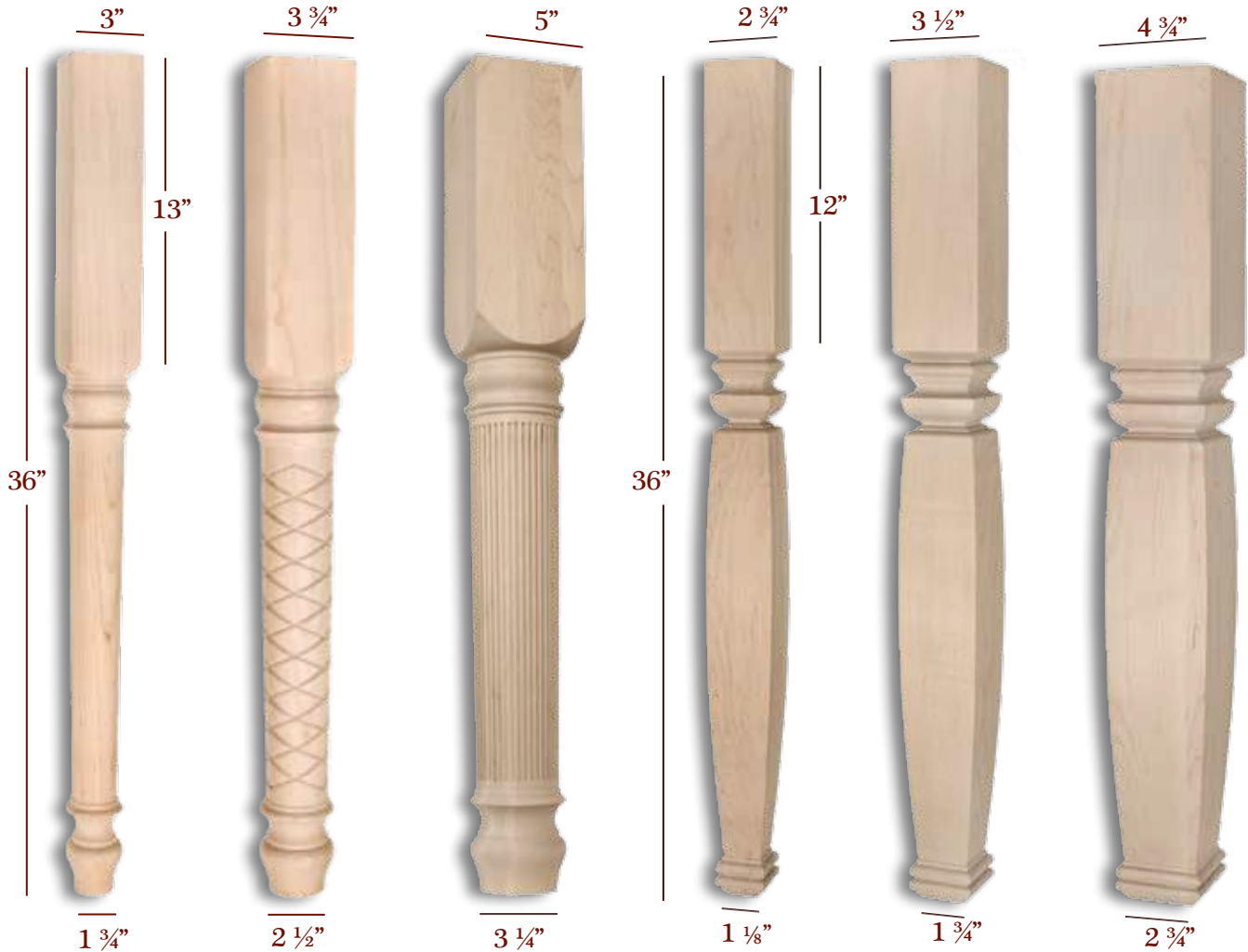

ISL6300P

ISL6375D

ISL6500E

ISL17275CP

ISL17350CP

ISL17475CP

Available in Alder, Cherry, Maple,
Poplar, Red Oak & Rubberwood
Other Species upon request

Available in Alder, Cherry, Maple,
Poplar, Red Oak & Rubberwood
Other Species upon request

✱ *Lincoln Series is also available in 15-1/2", 18, 21 & 29"*
See Pages 173-175

*Find a matching
Bun Foot on
page 15*



BF960

Item No.	Description	Tall	Width	Top Shank Length	Toe
ISL6300D	Diamond Round	36"	3"	13"	1-3/4"
ISL6300E	Reeded Round	36"	3"	13"	1-3/4"
ISL6300P	Plain Round	36"	3"	13"	1-3/4"
ISL6375D	Diamond Round	36"	3-3/4"	13"	2-1/2"
ISL6375E	Reeded Round	36"	3-3/4"	13"	2-1/2"
ISL6375P	Plain Round	36"	3-3/4"	13"	2-1/2"
ISL6500D	Diamond Round	36"	5"	13"	3-1/4"
ISL6500E	Reeded Round	36"	5"	13"	3-1/4"
ISL6500P	Plain Round	36"	5"	13"	3-1/4"
ISL17275CP	Plain Square	36"	2-3/4"	12"	1-1/8"
ISL17350CP	Plain Square	36"	3-1/2"	12"	1-3/4"
ISL17475CP	Plain Square	36"	4-3/4"	12"	2-3/4"

"Leading the Pack"

MADISON

36" & 42" Posts & Legs

	Item No.	Description	Tall	Width	Top Shank Length	Bottom Shank Length
Diamond	BAR8300D	Diamond Round	42"	3"	8"	6-3/4"
	BAR8375D	Diamond Round	42"	3-3/4"	8"	6-3/4"
	BAR8500D	Diamond Round	42"	5"	8"	6-3/4"
	ISL8300D	Diamond Round	36"	3"	8"	6-3/4"
	ISL8375D	Diamond Round	36"	3-3/4"	8"	6-3/4"
Reeded	ISL8500D	Diamond Round	36"	5"	8"	6-3/4"
	BAR8300E	Reeded Round	42"	3"	8"	6-3/4"
	BAR8375E	Reeded Round	42"	3-3/4"	8"	6-3/4"
	BAR8500E	Reeded Round	42"	5"	8"	6-3/4"
	ISL8300E	Reeded Round	36"	3"	8"	6-3/4"
Fluted	ISL8350E	Reeded Round	36"	3-1/2"	8"	6-3/4"
	ISL8375E	Reeded Round	36"	3-3/4"	8"	6-3/4"
	ISL8500E	Reeded Round	36"	5"	8"	6-3/4"
	BAR8300F	Fluted Round	42"	3"	8"	6-3/4"
	BAR8375F	Fluted Round	42"	3-3/4"	8"	6-3/4"
Plain	BAR8500F	Fluted Round	42"	5"	8"	6-3/4"
	ISL8300F	Fluted Round	36"	3"	8"	6-3/4"
	ISL8375F	Fluted Round	36"	3-3/4"	8"	6-3/4"
	ISL8500F	Fluted Round	36"	5"	8"	6-3/4"
	BAR8300P	Plain Round	42"	3"	8"	6-3/4"
Roped	BAR8375P	Plain Round	42"	3-3/4"	8"	6-3/4"
	BAR8500P	Plain Round	42"	5"	8"	6-3/4"
	ISL8300P	Plain Round	36"	3"	8"	6-3/4"
	ISL8350P	Plain Round	36"	3-1/2"	8"	6-3/4"
	ISL8375P	Plain Round	36"	3-3/4"	8"	6-3/4"
	ISL8500P	Plain Round	36"	5"	8"	6-3/4"
	BAR8300R	Roped Round	42"	3"	8"	6-3/4"
	BAR8375R	Roped Round	42"	3-3/4"	8"	6-3/4"
	BAR8500R	Roped Round	42"	5"	8"	6-3/4"
	ISL8300R	Roped Round	36"	3"	8"	6-3/4"
ISL8350R	Roped Round	36"	3-1/2"	8"	6-3/4"	
ISL8375R	Roped Round	36"	3-3/4"	8"	6-3/4"	
ISL8500R	Roped Round	36"	5"	8"	6-3/4"	

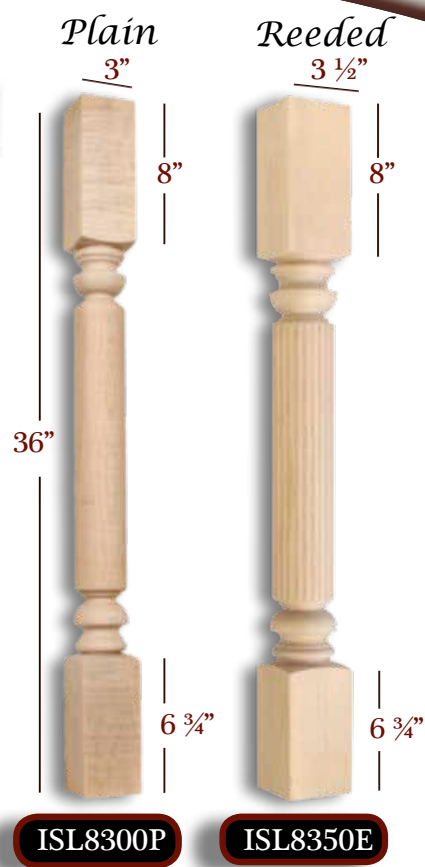

ISL8300P

ISL8350E

Available in Alder, Cherry, Maple, Poplar, Red Oak & Rubberwood
Other Species upon request

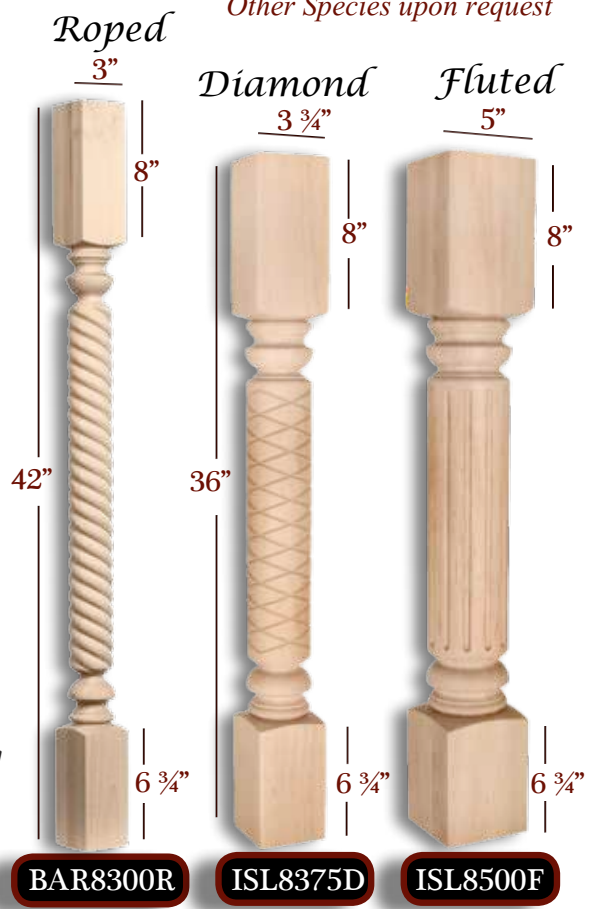

BAR8300R

ISL8375D

ISL8500F



ISL8350E
Shown in Picture



BF945

Find a matching
Bun Foot on
page 15

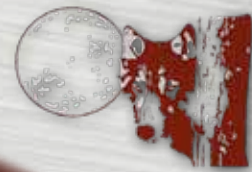

MISSION

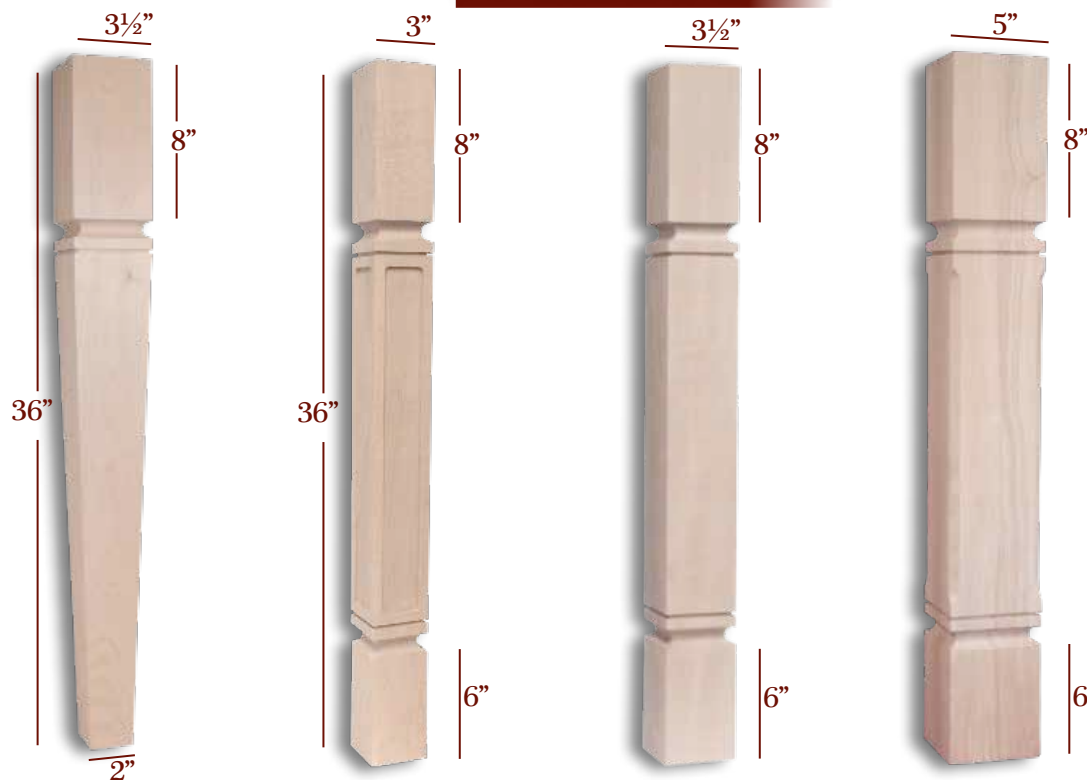

ISL22350-TP

ISL22300-FW

ISL22350-CP

ISL22500-CC

36" & 42" Posts & Legs

	Item No.	Tall	Overall Width	Top Shank Length	Bottom Shank Length	Toe
Chamfered Corners	BAR22300-CC	42"	3"	8"	6"	N/A
	BAR22350-CC	42"	3-1/2"	8"	6"	N/A
	BAR22500-CC	42"	5"	8"	6"	N/A
	ISL22300-CC	36"	3"	8"	6"	N/A
	ISL22350-CC	36"	3-1/2"	8"	6"	N/A
	ISL22500-CC	36"	5"	8"	6"	N/A
Plain	BAR22300-CP	42"	3"	8"	6"	N/A
	BAR22350-CP	42"	3-1/2"	8"	6"	N/A
	BAR22500-CP	42"	5"	8"	6"	N/A
	ISL22300-CP	36"	3"	8"	6"	N/A
	ISL22350-CP	36"	3-1/2"	8"	6"	N/A
	ISL22500-CP	36"	5"	8"	6"	N/A
Full Window	BAR22300-FW	42"	3"	8"	6"	N/A
	BAR22350-FW	42"	3-1/2"	8"	6"	N/A
	BAR22500-FW	42"	5"	8"	6"	N/A
	ISL22300-FW	36"	3"	8"	6"	N/A
	ISL22350-FW	36"	3-1/2"	8"	6"	N/A
	ISL22500-FW	36"	5"	8"	6"	N/A
Outline Window	BAR22300-OW	42"	3"	8"	6"	N/A
	BAR22350-OW	42"	3-1/2"	8"	6"	N/A
	BAR22500-OW	42"	5"	8"	6"	N/A
	ISL22300-OW	36"	3"	8"	6"	N/A
	ISL22350-OW	36"	3-1/2"	8"	6"	N/A
	ISL22500-OW	36"	5"	8"	6"	N/A
Taper	ISL22300-TP	36"	3"	8"	N/A	1-1/2"
	ISL22350-TP	36"	3-1/2"	8"	N/A	2"
	ISL22500-TP	36"	5"	8"	N/A	3-1/2"



BF965-C



BFS22S



BFS22L

Find a matching
Bum Foot on
pages 14 & 15

"Leading the Pack"

MONACO MONTE CRISTO

36" & 42" Posts & Legs

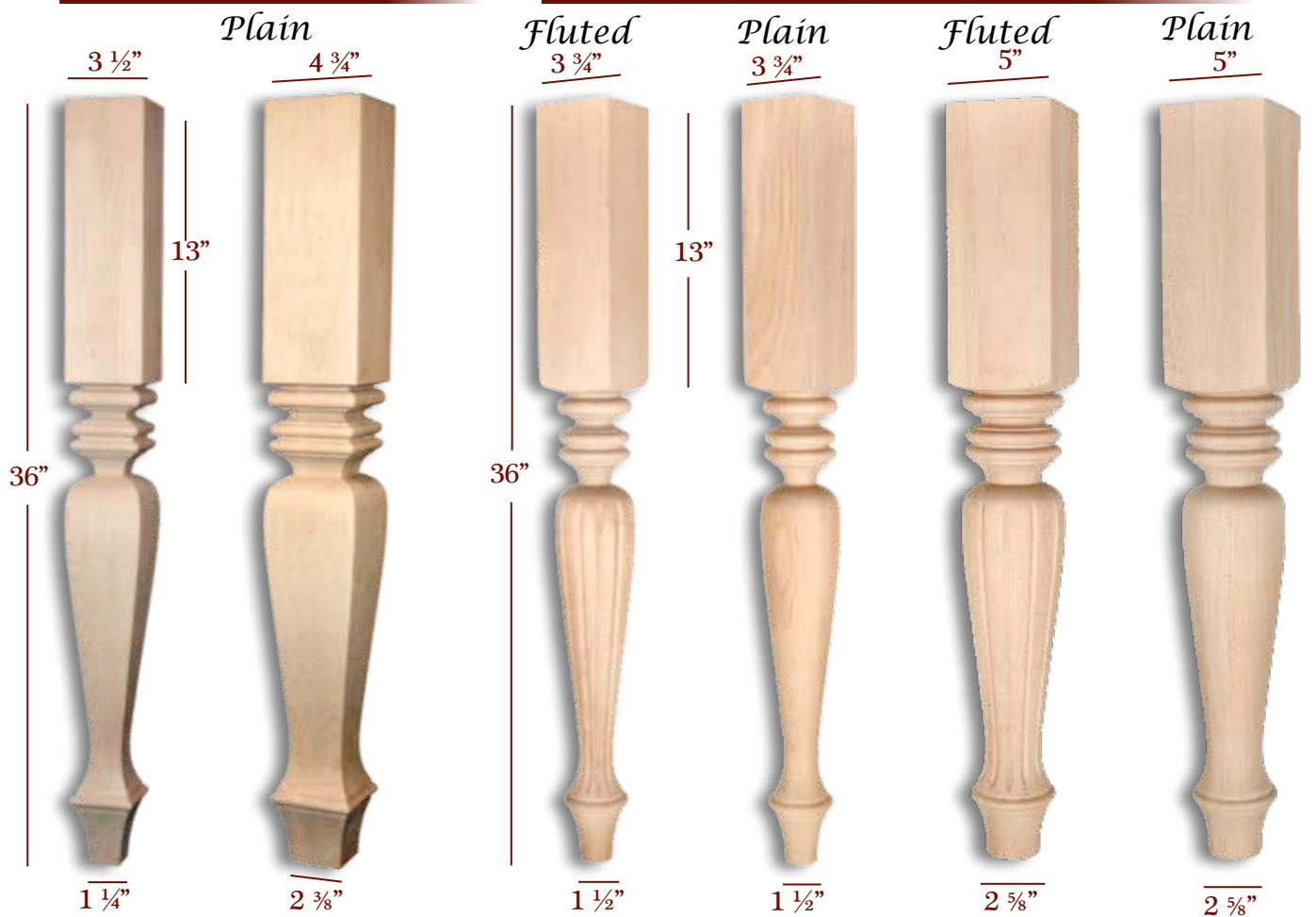

ISL21350CP **ISL21475CP** **ISL11375F** **ISL11375P** **ISL11500F** **ISL11500P**

Available in Alder, Cherry, Maple, Poplar, Red Oak & Rubberwood
Other Species upon request

Available in Alder, Cherry, Maple, Poplar, Red Oak & Rubberwood
Other Species upon request

Item No.	Description	Tall	Width	Top Shank Length	Toe
ISL11375F	Fluted	36"	3-3/4"	13"	1-1/2"
ISL11375P	Plain	36"	3-3/4"	13"	1-1/2"
ISL11500F	Fluted	36"	5"	13"	2-5/8"
ISL11500P	Plain	36"	5"	13"	2-5/8"
ISL21350CP	Plain Square	36"	3-1/2"	13"	1-1/4"
ISL21475CP	Plain Square	36"	4-3/4"	13"	2-3/8"



BF914-C BF912 BF913

Find a matching
Bun Foot on
page 14



ISL11375P
Shown in Picture

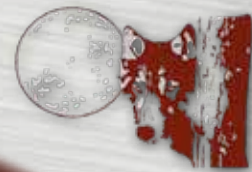

ROCHESTER

ROOSEVELT



ISL32500P



ISL36350P



ISL36500P

36" & 42" Posts & Legs

*Available in Alder, Cherry, Maple, Poplar, Red Oak & Rubberwood
Other Species upon request*

Item No.	Description	Tall	Width	Top Shank Length	Bottom Shank Length	Toe
ISL32500P	Plain	36"	5"	7-5/8"	6"	N/A
ISL36350P	Plain	36"	3-1/2"	9-1/2"	N/A	2"
ISL36500P	Plain	36"	5"	9-1/2"	N/A	3-1/2"



BF900



BF901



BF919



BF966



BF-P002

*Find a matching
Bun Foot on
pages 14-16*



"Leading the Pack"

SALEM ✱

36" & 42" Posts & Legs

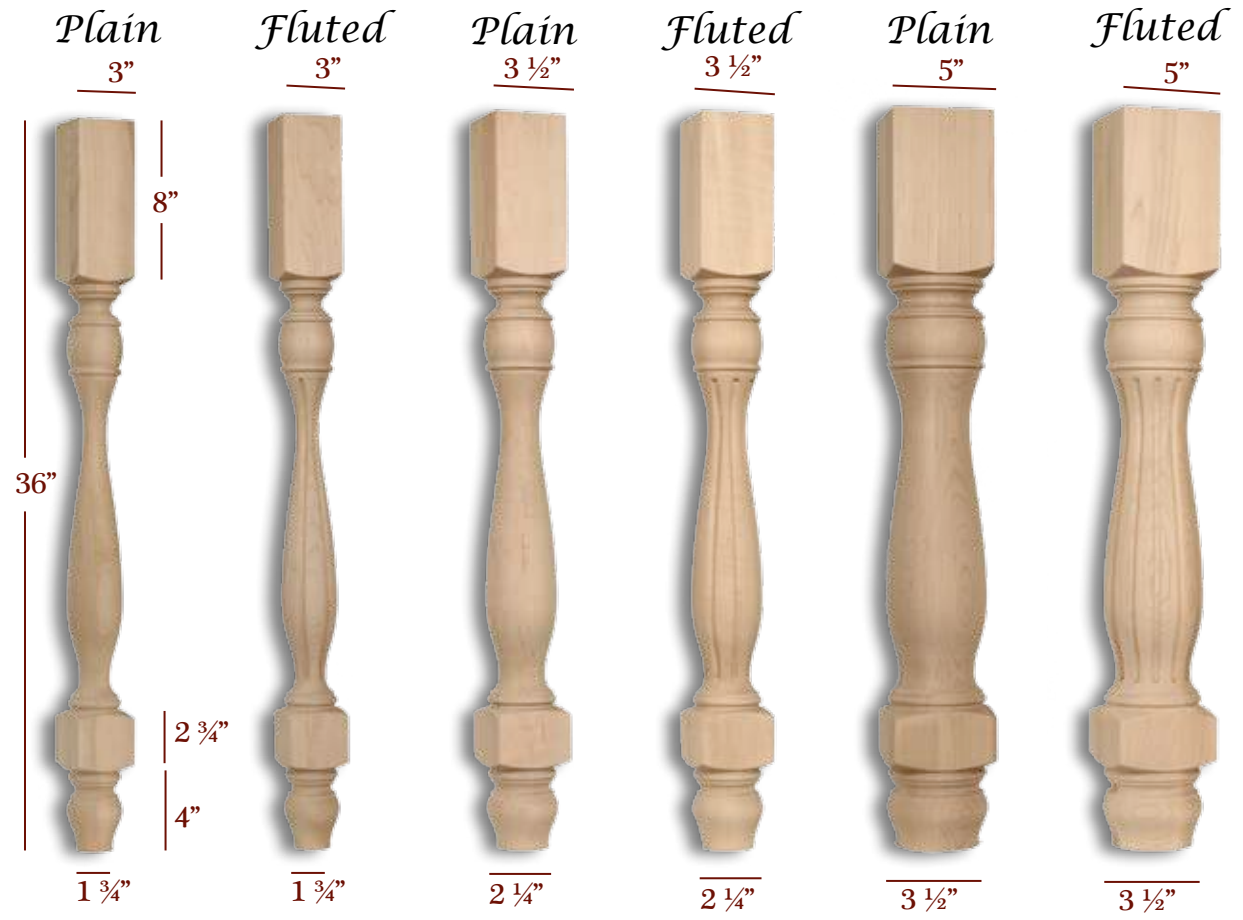

ISL19300P **ISL19300F** **ISL19350P** **ISL19350F** **ISL19500P** **ISL19500F**

Available in Alder, Cherry, Maple, Poplar, Red Oak & Rubberwood
Other Species upon request

Item No.	Desc.	Tall	Width	Top Shank Length	Block	Toe
BAR19300F	Fluted	42"	3"	12"	2-3/4"	1-3/4"
BAR19300P	Plain	42"	3"	12"	2-3/4"	1-3/4"
BAR19350F	Fluted	42"	3-1/2"	12"	2-3/4"	2-1/4"
BAR19350P	Plain	42"	3-1/2"	12"	2-3/4"	2-1/4"
BAR19375F	Fluted	42"	3-3/4"	12"	2-3/4"	2-1/2"
BAR19375P	Plain	42"	3-3/4"	12"	2-3/4"	2-1/2"
BAR19500F	Fluted	42"	5"	12"	2-3/4"	3-1/2"
BAR19500P	Plain	42"	5"	12"	2-3/4"	3-1/2"
ISL19300F	Fluted	36"	3"	8"	2-3/4"	1-3/4"
ISL19300P	Plain	36"	3"	8"	2-3/4"	1-3/4"
ISL19350F	Fluted	36"	3-1/2"	8"	2-3/4"	2-1/4"
ISL19350P	Plain	36"	3-1/2"	8"	2-3/4"	2-1/4"
ISL19375F	Fluted	36"	3-3/4"	8"	2-3/4"	2-1/2"
ISL19375P	Plain	36"	3-3/4"	8"	2-3/4"	2-1/2"
ISL19500F	Fluted	36"	5"	8"	2-3/4"	3-1/2"
ISL19500P	Plain	36"	5"	8"	2-3/4"	3-1/2"



BF919



BF963



BF960

Find a matching
Bun Foot on
page 15



BAR19500F & BAR19375F
Shown in Picture

✱ Salem Series is also available in 29" & 42"
See Pages 74 & 178

American Made

Phone: 877-504-WOLF
(9 6 5 3)
sales@TimberWolfForest.com

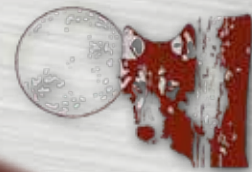

SANTA FE ❄

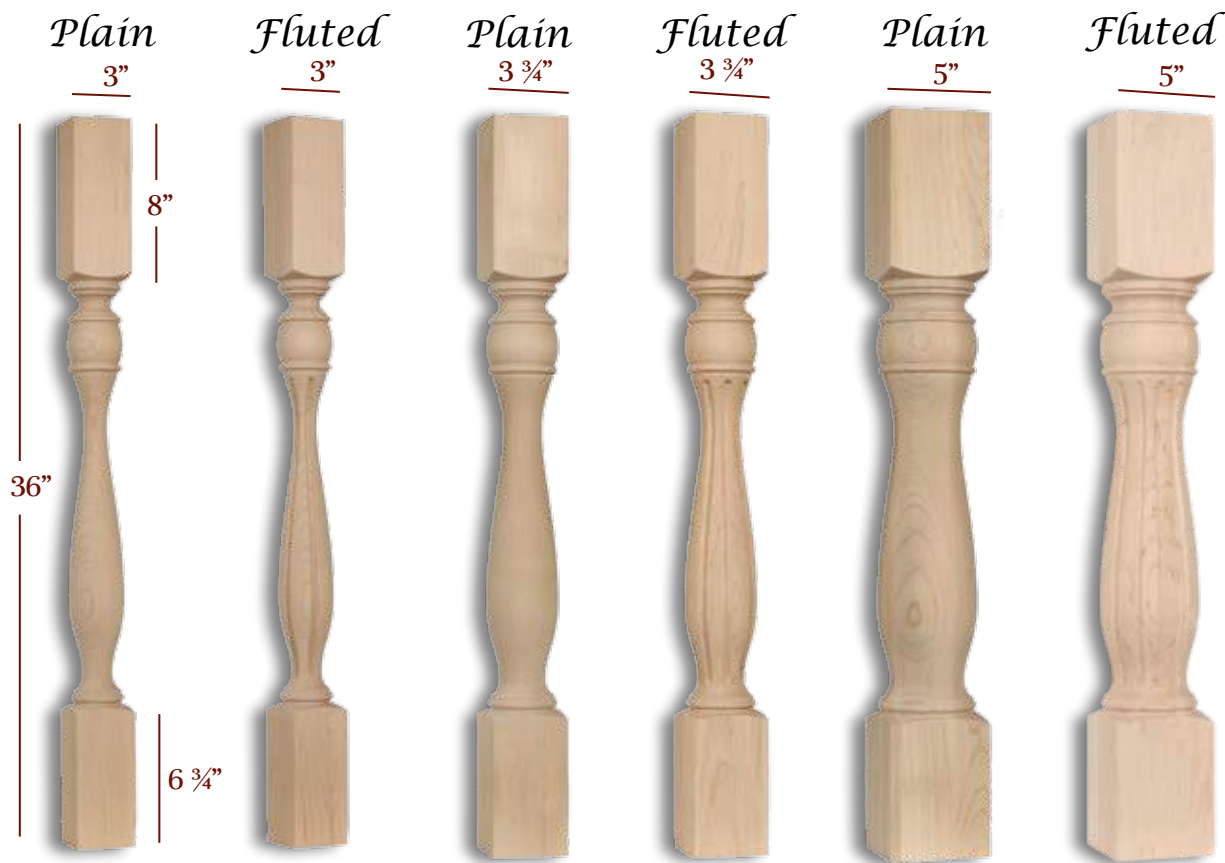

36" & 42" Posts & Legs

ISL20300P

ISL20300F

ISL20375P

ISL20375F

ISL20500P

ISL20500F

*Available in Alder, Cherry, Maple,
Poplar, Red Oak & Rubberwood
Other Species upon request*

Item No.	Desc.	Tall	Width	Top Shank Length	Bottom Shank Length
BAR20300F	Fluted	42"	3"	12"	6-3/4"
BAR20300P	Plain	42"	3"	12"	6-3/4"
BAR20375F	Fluted	42"	3-3/4"	12"	6-3/4"
BAR20375P	Plain	42"	3-3/4"	12"	6-3/4"
BAR20500F	Fluted	42"	5"	12"	6-3/4"
BAR20500P	Plain	42"	5"	12"	6-3/4"
ISL20300F	Fluted	36"	3"	8"	6-3/4"
ISL20300P	Plain	36"	3"	8"	6-3/4"
ISL20350F	Fluted	36"	3-1/2"	8"	6-3/4"
ISL20350P	Plain	36"	3-1/2"	8"	6-3/4"
ISL20375F	Fluted	36"	3-3/4"	8"	6-3/4"
ISL20375P	Plain	36"	3-3/4"	8"	6-3/4"
ISL20500F	Fluted	36"	5"	8"	6-3/4"
ISL20500P	Plain	36"	5"	8"	6-3/4"



ISL20375P & ISL20500P
Shown in Picture

❄ *Santa Fe Series is also available in 29" & 42"*
See Pages 76 & 179

"Leading the Pack"

SAVANNAH ✱

36" & 42" Posts & Legs

Reeded
3 3/4"

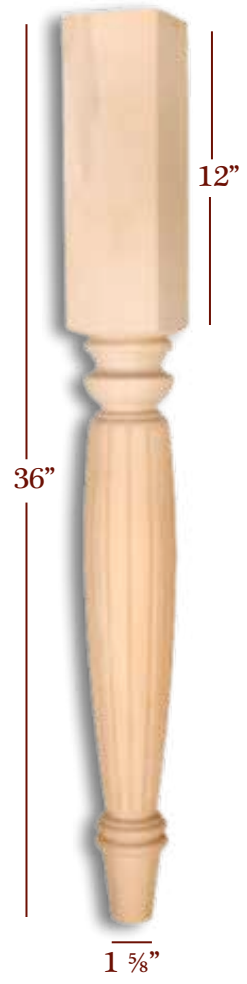

ISL7375E

Plain
3 3/4"



ISL7375P

Reeded
5"



ISL7500E

Plain
5"



ISL7500P

*Available in Alder, Cherry, Maple,
Poplar, Red Oak & Rubberwood
Other Species upon request*

Item No.	Description	Tall	Width	Top Shank Length	Toe
ISL7375E	Reeded	36"	3-3/4"	12"	1-5/8"
ISL7375P	Plain	36"	3-3/4"	12"	1-5/8"
ISL7500E	Reeded	36"	5"	12"	2-3/4"
ISL7500P	Plain	36"	5"	12"	2-3/4"



BF925



BF983

*Find a matching
Bun Foot on
pages 15 & 16*

✱ *Savannah Series is also available in 29"*
See Page 180

American Made

Phone: 877-504-WOLF
(9653)
sales@TimberWolfForest.com

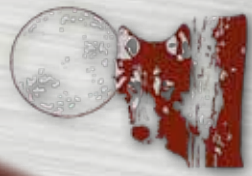

SHAKER ✱

Two Sided Taper Toe

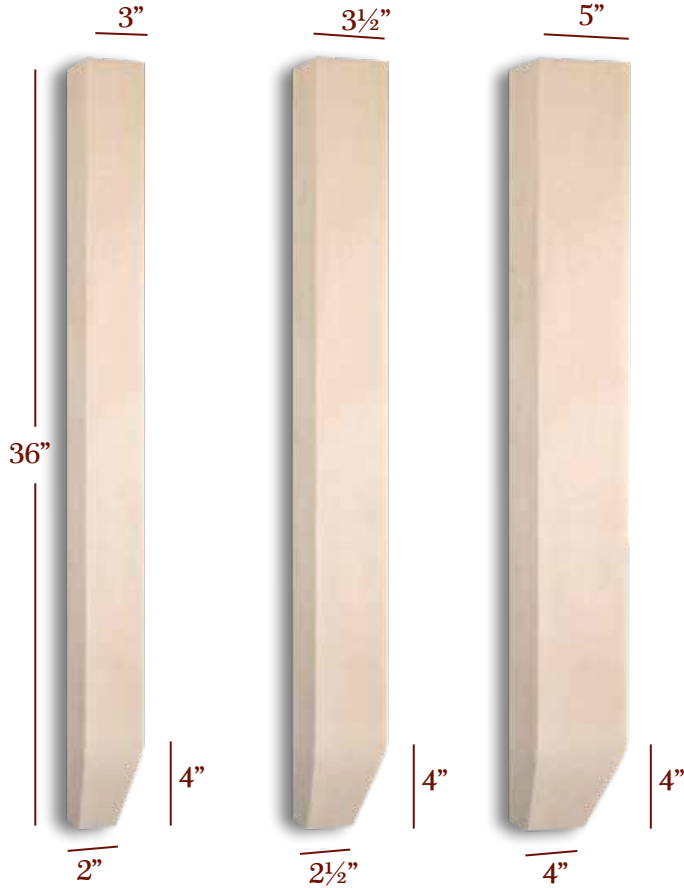

ISL98300P-2ST

ISL98350P-2ST

ISL98500P-2ST

SKYLINE ✱

Straight Plain

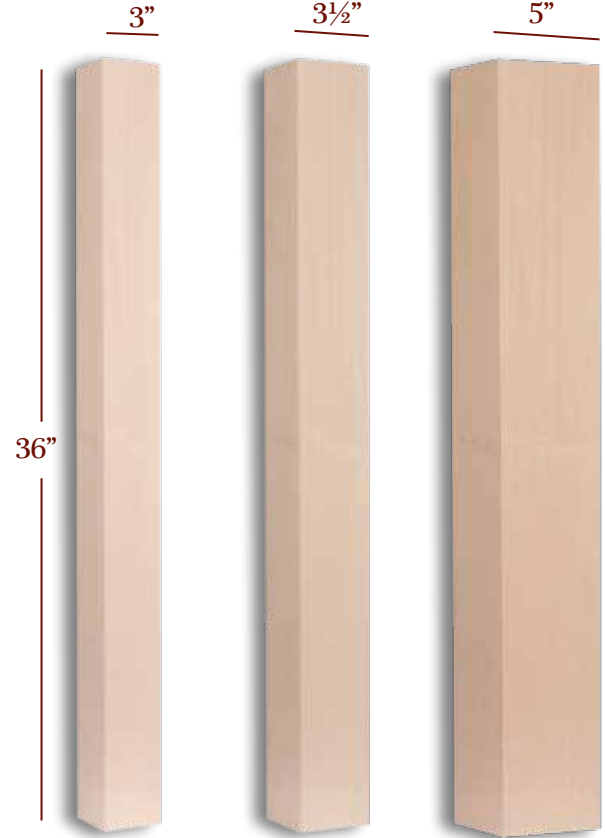

ISL99300P

ISL98350P

ISL98500P

36" & 42" Posts & Legs

✱ *Shaker & Skyline Series are also available in 29" & 42" upon request
See Table Below & Pages 80 & 82*



*Pictured Left to Right:
BF225-95, BF225-80,
BF225-55*

*Available in
Alder, Cherry,
Maple, Poplar,
Red Oak &
Rubberwood
Other Species
upon Request*

Item No.	Description	Tall	Width	Taper Length to Floor	Toe
BAR98300P-2ST	Tapered Shaker Square	42"	3"	4"	2"
BAR98350P-2ST	Tapered Shaker Square	42"	3-1/2"	4"	2-1/2"
BAR98375P-2ST	Tapered Shaker Square	42"	3-3/4"	4"	2-3/4"
BAR98500P-2ST	Tapered Shaker Square	42"	5"	4"	4"
ISL98300P-2ST	Tapered Shaker Square	36"	3"	4"	2"
ISL98350P-2ST	Tapered Shaker Square	36"	3-1/2"	4"	2-1/2"
ISL98375P-2ST	Tapered Shaker Square	36"	3-3/4"	4"	2-3/4"
ISL98500P-2ST	Tapered Shaker Square	36"	5"	4"	4"
BAR99300P	Plain Straight Square	42"	3"	N/A	N/A
BAR99350P	Plain Straight Square	42"	3-1/2"	N/A	N/A
BAR99375P	Plain Straight Square	42"	3-3/4"	N/A	N/A
BAR99500P	Plain Straight Square	42"	5"	N/A	N/A
ISL99300P	Plain Straight Square	36"	3"	N/A	N/A
ISL99350P	Plain Straight Square	36"	3-1/2"	N/A	N/A
ISL99375P	Plain Straight Square	36"	3-3/4"	N/A	N/A
ISL99500P	Plain Straight Square	36"	5"	N/A	N/A



BF801



BF820

*Find a matching
Bun Foot on
page 14*

"Leading the Pack"

TRUMAN

VANDERBILT

36" & 42" Posts & Legs

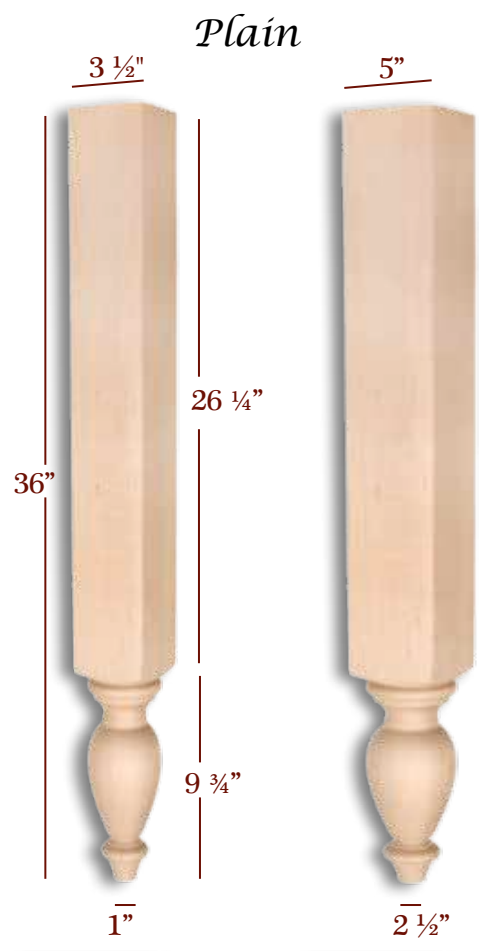

ISL42350P
Also part number
HB1035

ISL42500P

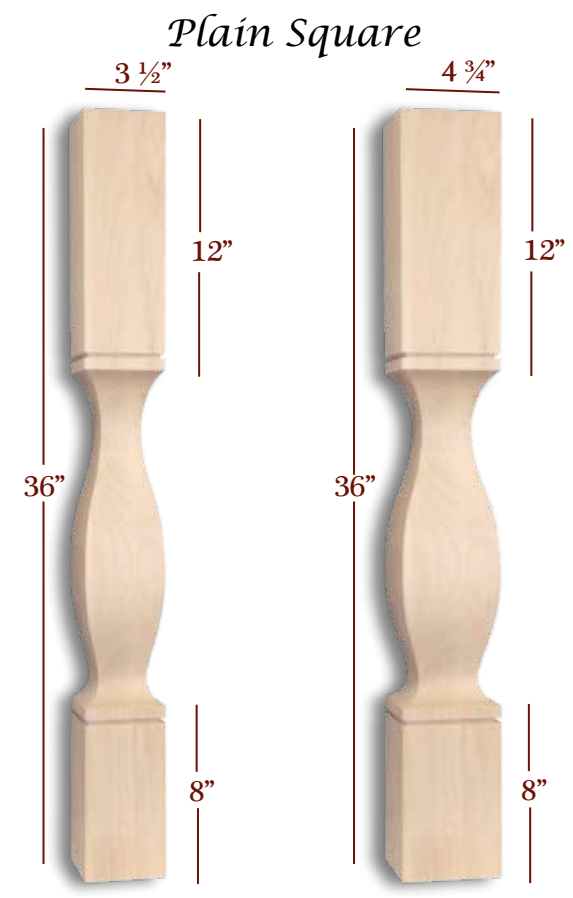

ISL16350CP

ISL16475CP



BF927-C

BF965-C

Item No.	Desc.	Tall	Width	Top Shank Length	Bottom Shank Length
ISL16350CP	Square Plain	36"	3-1/2"	12"	8"
ISL16475CP	Square Plain	36"	4-3/4"	12"	8"
ISL42350P	Plain	36"	3-1/2"	26-1/4"	N/A
ISL42500P	Plain	36"	5"	26-1/4"	N/A

Available in Alder, Cherry, Maple,
Poplar, Red Oak & Rubberwood
Other Species upon request

Find a matching
Bun Foot on
page 15

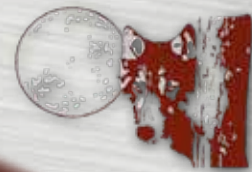

VICTORIA ✱

Available in Alder, Cherry, Maple,
Poplar, Red Oak & Rubberwood
Other Species upon request

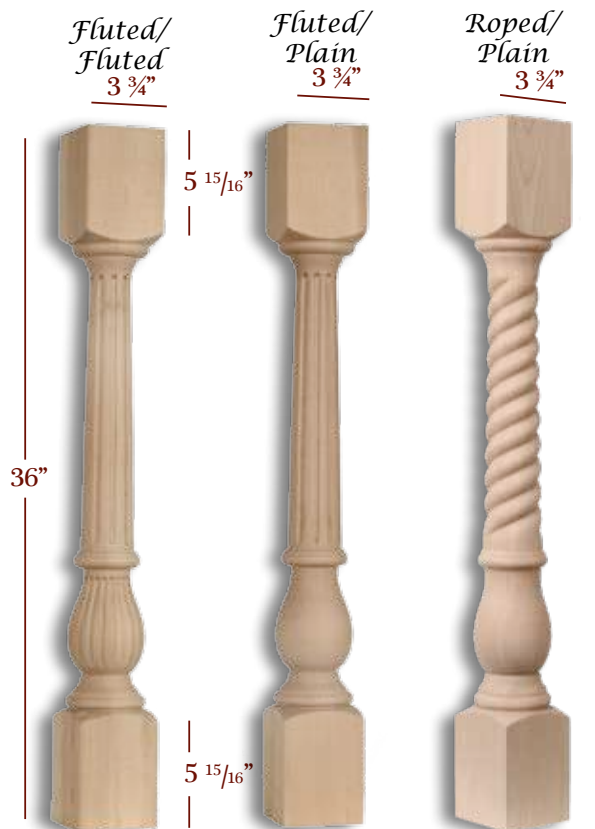

ISL15375FF

ISL15375FP

ISL15375RP

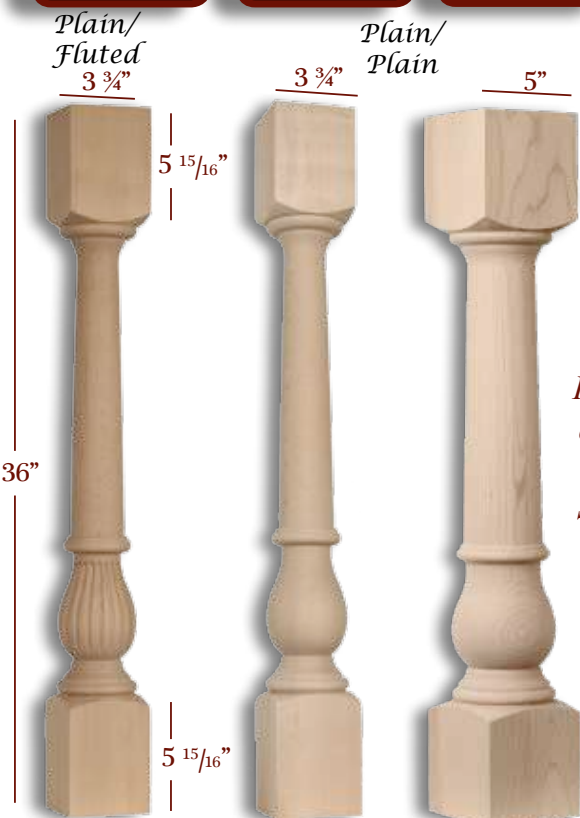

ISL15375PF

ISL15375PP

ISL15500PP

Item No.	Desc.	Tall	Width	Top Shank Length	Bottom Shank Length
BAR15375FF	Fluted/Fluted	42"	3-3/4"	8"	5-15/16"
BAR15500FF	Fluted/Fluted	42"	5"	8"	5-15/16"
ISL15375FF	Fluted/Fluted	36"	3-3/4"	5-15/16"	5-15/16"
ISL15500FF	Fluted/Fluted	36"	5"	5-15/16"	5-15/16"
BAR15375FP	Fluted/Plain	42"	3-3/4"	8"	5-15/16"
BAR15500FP	Fluted/Plain	42"	5"	8"	5-15/16"
ISL15375FP	Fluted/Plain	36"	3-3/4"	5-15/16"	5-15/16"
ISL15500FP	Fluted/Plain	36"	5"	5-15/16"	5-15/16"
BAR15375RP	Roped/Plain	42"	3-3/4"	8"	5-15/16"
BAR15500RP	Roped/Plain	42"	5"	8"	5-15/16"
ISL15375RP	Roped/Plain	36"	3-3/4"	5-15/16"	5-15/16"
ISL15500RP	Roped/Plain	36"	5"	5-15/16"	5-15/16"
BAR15300PF	Plain/Fluted	42"	3"	8"	5-15/16"
BAR15375PF	Plain/Fluted	42"	3-3/4"	8"	5-15/16"
BAR15500PF	Plain/Fluted	42"	5"	8"	5-15/16"
ISL15300PF	Plain/Fluted	36"	3"	5-15/16"	5-15/16"
ISL15375PF	Plain/Fluted	36"	3-3/4"	5-15/16"	5-15/16"
ISL15500PF	Plain/Fluted	36"	5"	5-15/16"	5-15/16"
BAR15300PP	Plain/Plain	42"	3"	8"	5-15/16"
BAR15375PP	Plain/Plain	42"	3-3/4"	8"	5-15/16"
BAR15500PP	Plain/Plain	42"	5"	8"	5-15/16"
ISL15300PP	Plain/Plain	36"	3"	5-15/16"	5-15/16"
ISL15375PP	Plain/Plain	36"	3-3/4"	5-15/16"	5-15/16"
ISL15500PP	Plain/Plain	36"	5"	5-15/16"	5-15/16"

✱ Victoria Series is also available in 42"
See Table Above

Victoria Series Posts also available in 5"
See Table Above



ISL15375PF, ISL15375FP,
ISL15375PP & ISL15375FF
Shown in Picture

36" & 42" Posts & Legs



"Leading the Pack"

WILLIAMSBURG * WINSTON ***

Plain

Plain

36" & 42" Posts & Legs

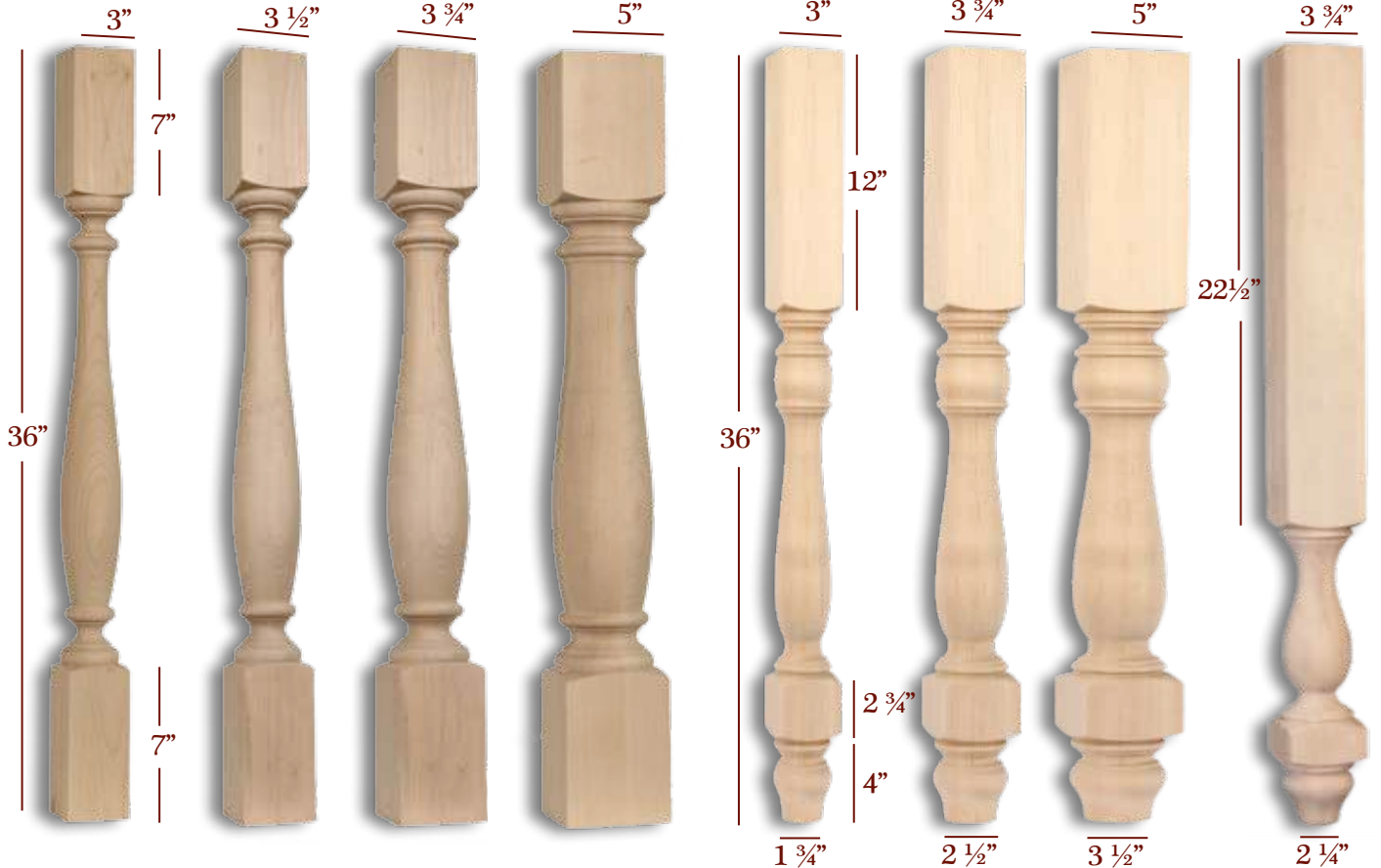

- ISL12300P
- ISL12350P
- ISL12375P
- ISL12500P
- ISL9300P
- ISL9375P
- ISL9500P
- HB9375-36

* Williamsburg Series is available in 42"
See Table Below

** Winston Series Island Legs are
also available in 29"

36" Available in
Alder, Cherry,
Maple, Poplar,
Red Oak
& Rubberwood
Other Species
upon request

Item No.	Desc.	Tall	Width	Top Shank Length	Bottom Shank Length	Block	Toe
BAR12300P	Plain Round	42"	3"	13"	7"	N/A	N/A
BAR12350P	Plain Round	42"	3-1/2"	13"	7"	N/A	N/A
BAR12500P	Plain Round	42"	5"	13"	7"	N/A	N/A
ISL12300P	Plain Round	36"	3"	7"	7"	N/A	N/A
ISL12350P	Plain Round	36"	3-1/2"	7"	7"	N/A	N/A
ISL12375P	Plain Round	36"	3-3/4"	7"	7"	N/A	N/A
ISL12500P	Plain Round	36"	5"	7"	7"	N/A	N/A
ISL9300P	Plain Round	36"	3"	12"	N/A	2-3/4"	1-3/4"
ISL9375P	Plain Round	36"	3-3/4"	12"	N/A	2-3/4"	2-1/2"
ISL9500P	Plain Round	36"	5"	12"	N/A	2-3/4"	3-1/2"
HB9300-36	Plain Round	36"	3"	22-1/2"	N/A	1-3/4"	1-1/2"
HB9350P-36	Plain Round	36"	3-1/2"	22-1/2"	N/A	1-3/4"	2"
HB9375P-36	Plain Round	36"	3-3/4"	22-1/2"	N/A	1-3/4"	2-1/4"
HB9500P-36	Plain Round	36"	5"	22-1/2"	N/A	1-3/4"	3-1/2"

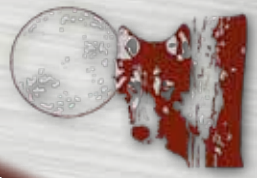

CORNER POSTS & VANITY LEGS



CP-STP-32 & PFC-CS-4
Shown in Picture



"Leading the Pack"

CATHEDRAL

Available in Alder, Cherry, Maple, Poplar, Red Oak & Rubberwood
Other Species upon request

CORNER POSTS

QUEEN ANNE STYLE ROUND FACE SQUARE FACE
Fluted Plain Plain Fluted Plain Fluted Plain

Corner Posts & Vanity Legs

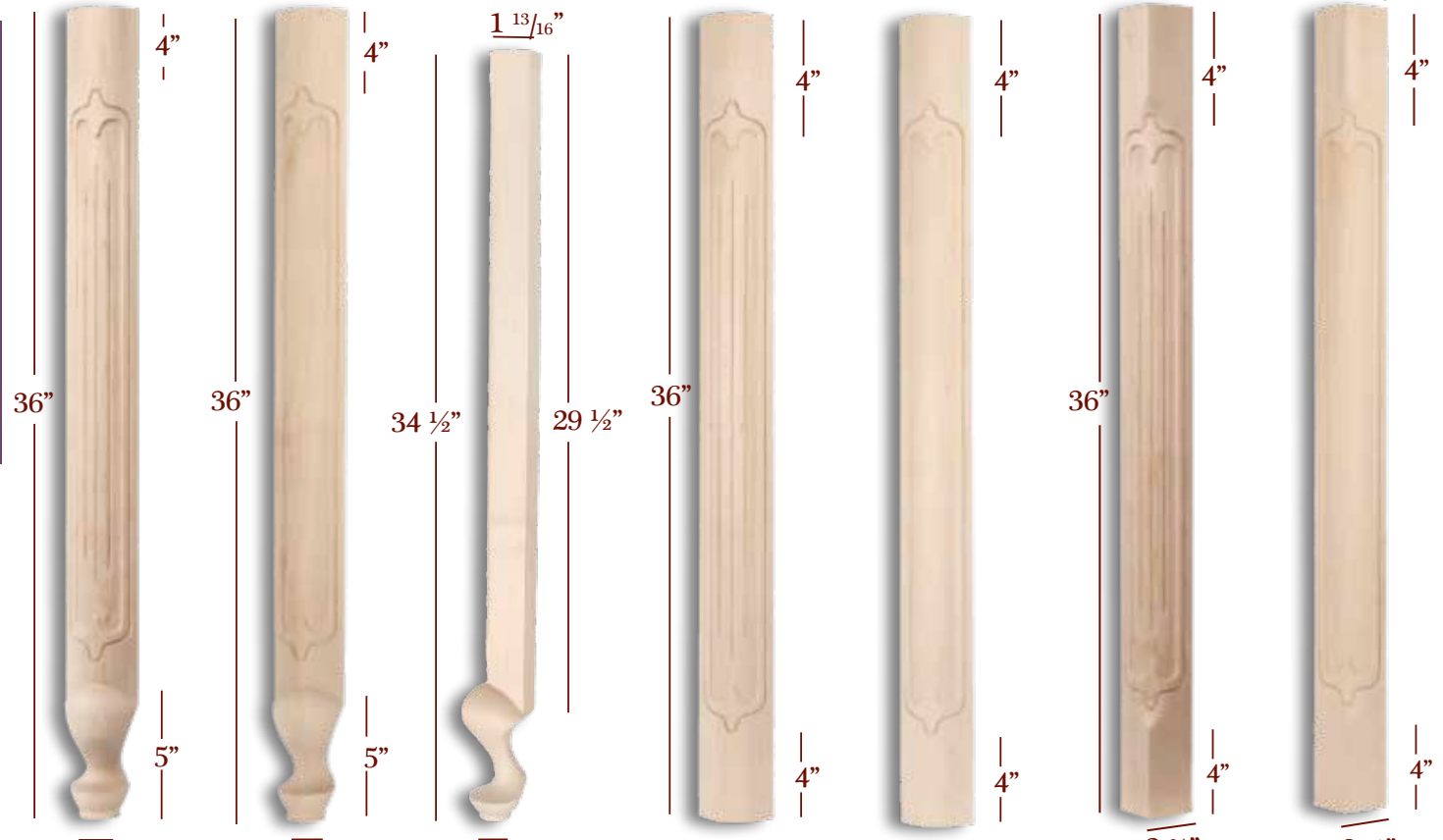

CP-QATF-36 CP-QATP-36 HB1000 CP-RTF-36 CP-RTP-36 CP-STF-36 CP-STP-36

Round & Square Face Posts Available in 32", 36" & 42" Tall

CP-QATF-36 & CP-QATP-36 Post Top End View

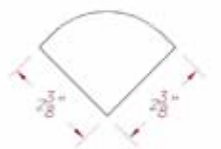

HB1000 Post Top End View



Round Face Corner Post Top End View



Square Face Corner Post Top End View



Item No.	Desc.	Tall	Width	Top Shank Length	Bottom Shank Length	Toe
CP-QATF-36	Fluted	36"	2-3/8"	4"	N/A	1-3/4"
CP-QATP-36	Plain	36"	2-3/8"	4"	N/A	1-3/4"
CP-RTF-32	Fluted	32"	2-3/8"	4"	4"	N/A
CP-RTF-36	Fluted	36"	2-3/8"	4"	4"	N/A
CP-RTF-42	Fluted	42"	2-3/8"	4"	4"	N/A
CP-RTP-32	Plain	32"	2-3/8"	4"	4"	N/A
CP-RTP-36	Plain	36"	2-3/8"	4"	4"	N/A
CP-RTP-42	Plain	42"	2-3/8"	4"	4"	N/A
CP-STF-32	Fluted	32"	2-3/8"	4"	4"	N/A
CP-STF-36	Fluted	36"	2-3/8"	4"	4"	N/A
CP-STF-42	Fluted	42"	2-3/8"	4"	4"	N/A
CP-STP-32	Plain	32"	2-3/8"	4"	4"	N/A
CP-STP-36	Plain	36"	2-3/8"	4"	4"	N/A
CP-STP-42	Plain	42"	2-3/8"	4"	4"	N/A
HB1000	Plain	42"	1-13/16"	4"	4"	N/A

Phone: 877-504-WOLF
(9653)
sales@TimberWolfForest.com



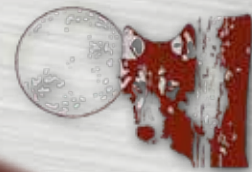

VANITY

GEORGIAN
Plain

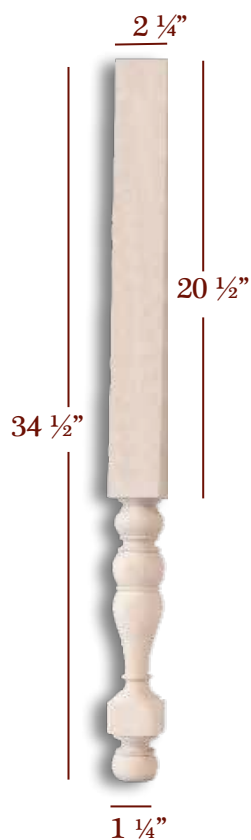

HB41225P-34.5

LINCOLN
Plain

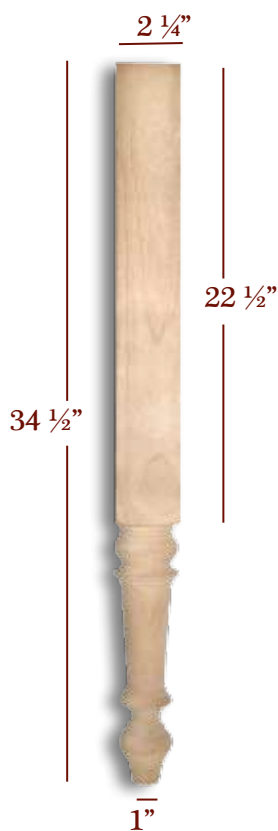

HB6225-34.5

TRUMAN
Plain

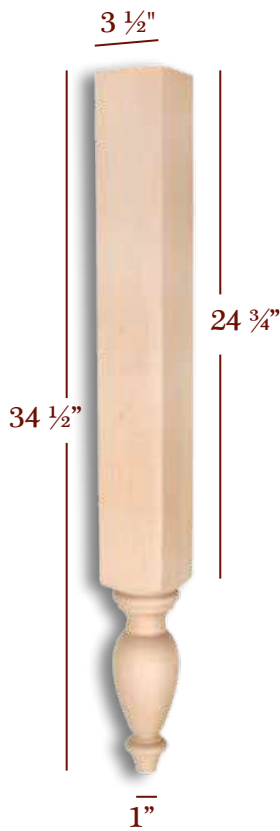

HB1035

WINSTON
Plain



HB9300-36

Corner Posts & Vanity Legs



Item No.	Desc.	Tall	Width	Top Shank Length	Toe
HB41225P-34.5	Plain Round	34-1/2"	2-1/4"	20-1/2"	1-1/4"
HB6225-34.5	Plain Round	34-1/2"	2-1/4"	22-1/2"	1"
HB1035	Plain Round	34-1/2"	3-1/2"	24-3/4"	1"
HB9300-36	Plain Round	36"	3"	22-1/2"	1-1/2"

*Available in Alder, Cherry, Maple, Poplar, Red Oak & Rubberwood
Other Species upon request*



"Leading the Pack"

JEBELLA

QUEEN ANNE LEGS

Corner Posts & Vanity Legs



HB1150

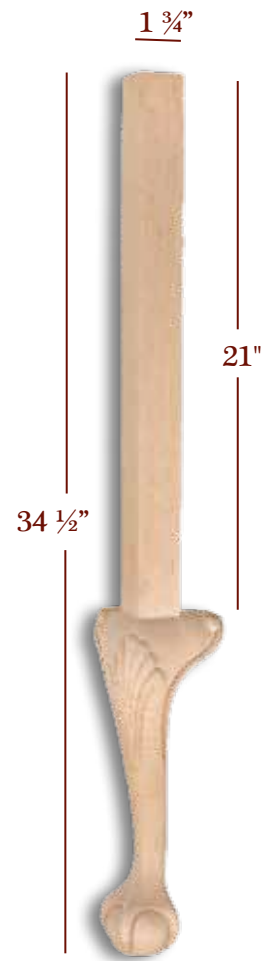

HB1250



HB1150
Shown in Picture

Item No.	Desc.	Tall	Overall Width	Top Shank Length	Toe
HB1150	High Boy Ball & Claw Queen Anne	34-1/2"	4-3/4"	16"	2"
HB1250	High Boy Ball & Claw Queen Anne	34-1/2"	4-1/2"	21"	2-1/8"

Available in Alder, Cherry, Maple,
Red Oak & Rubberwood
Other Species upon request

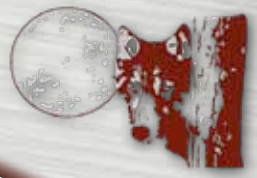

PEDESTAL & BUN FEET



BF927-C, BF959-C, BF914-C, BF929-C, BF928-C
BF993-C, BF926-C, BF958-C, & BF992-C

Shown in Picture

"Leading the Pack"

BUN FEET DESIGN INDEX



Pedestal & Bun Feet



ML1101F



CAB300-6



BFS14S



BFS14L



BFS22S



BFS22L



BFS41S



BFS41L



BF401-C



BF402-C



BF403-C



BF225-40



BF225-60



BF801



BF802



BF803



BF805



BF820



BF821



BF822



BF900



BF901



BF902



BF903



BF904-C



BF910



BF911



BF912



BF913



BF914-C



BF916



BF918-C



BF919



BF920-C



BF925



BF926-C



BF927-C



BF928-C



BF929-C



BF930



BF931



BF940



BF945



BF950



BF951



BF952



BF953



BF958-C



BF959-C



BF960



BF961-C



BF962-C



BF963



BF965-C



BF966



BF975



BF983



BF990



BF992-C



BF993-C



BF-P002



PFC-CS4



PFC-LC4



PFC-RC4



PFC-LS4



PFC-RS4

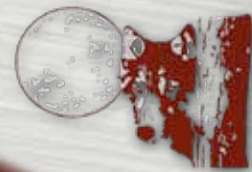

CATHEDRAL

4" & 4 1/2" PEDESTAL

Middle Moulding



Thickness = 3/4"

PFC-MM



CP-STP-32 & PFC-CS-4
Shown in Picture

Pedestal & Bun Feet

Corner Square Face

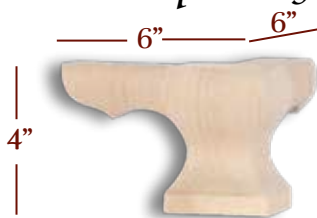

PFC-CS-4

Left Curved Edge



PFC-LC-4

Right Curved Edge



PFC-RC-4

Foot Thickness = 1"
Nailing Cleat = 1"

Corner Round Face



PFC-CR-4

Left Straight Edge



PFC-LS-4

Right Straight Edge

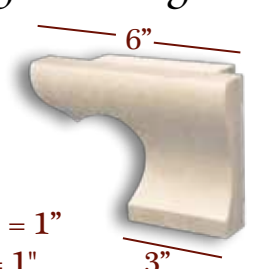

PFC-RS-4

Foot Thickness = 1"
Nailing Cleat = 1"

Pedestal feet available in 4" & 4-1/2". See table on this page.

Item No.	Desc.	Tall	Width	Deep	Toe	Foot Thickness	Nailing Cleat Thickness
PFC-MM	Middle Moulding	1-7/8"	10"	3/4"	N/A	N/A	N/A
PFC-CS-4	Corner Square Face	4"	6"	6"	3"	N/A	N/A
PFC-CS-4.5	Corner Square Face	4-1/2"	6"	6"	3"	N/A	N/A
PFC-LC-4	Left Curved Edge	4"	6"	2"	3"	1"	1"
PFC-LC-4.5	Left Curved Edge	4-1/2"	6"	2"	3"	1"	1"
PFC-RC-4	Right Curved Edge	4"	6"	2"	3"	1"	1"
PFC-RC-4.5	Right Curved Edge	4-1/2"	6"	2"	3"	1"	1"
PFC-CR-4	Corner Round Face	4"	6"	6"	2-5/8"	N/A	N/A
PFC-CR-4.5	Corner Round Face	4-1/2"	6"	6"	2-5/8"	N/A	N/A
PFC-LS-4	Left Straight Edge	4"	6"	2"	3"	1"	1"
PFC-LS-4.5	Left Straight Edge	4-1/2"	6"	2"	3"	1"	1"
PFC-RS-4	Right Straight Edge	4"	6"	2"	3"	1"	1"
PFC-RS-4.5	Right Straight Edge	4-1/2"	6"	2"	3"	1"	1"

*Available in Alder,
Cherry, Maple,
Poplar
& Red Oak
Other Species upon
request*



"Leading the Pack"

MADERA

PEDESTAL FEET

Pedestal & Bun Feet

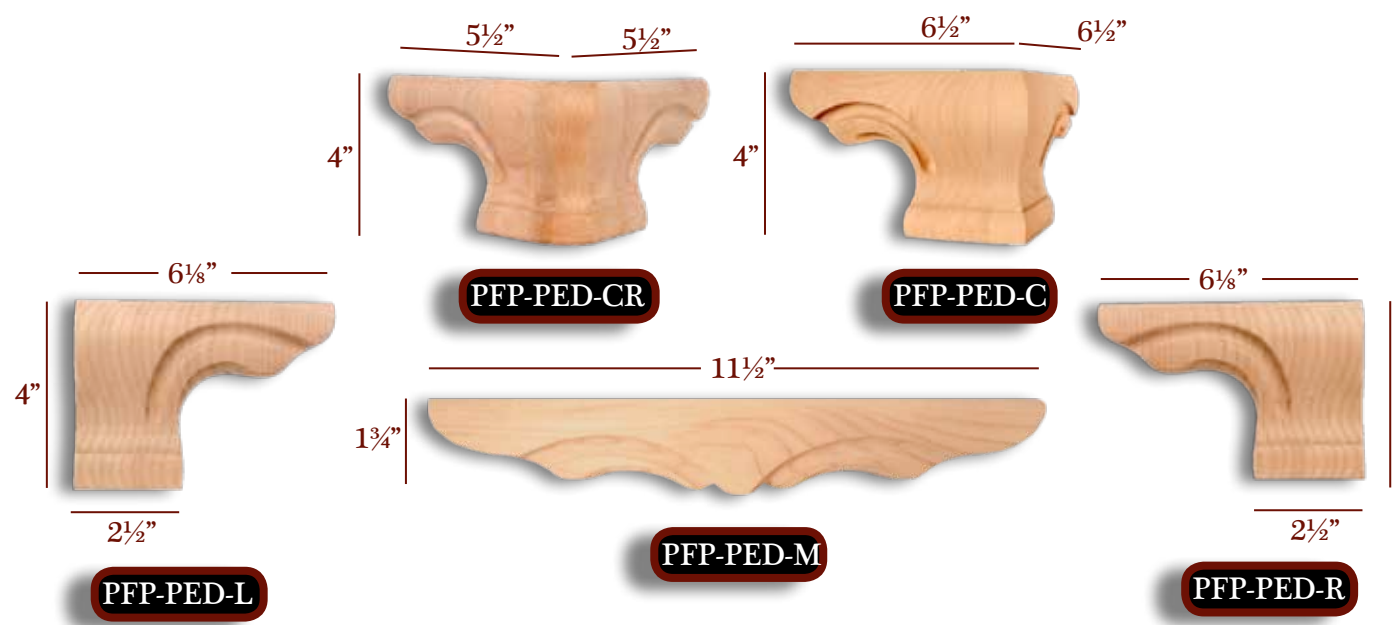

	Item No.	Description	Tall	Overall Width	Deep
MADERA SERIES	PFP-PED-M	Middle Moulding	1-3/4"	11-1/2"	1"
	PFP-PED-CR	Rounded Corner Pedestal Foot	4"	5-1-2"	5-1/2"
	PFP-PED-C	Square Corner Pedestal Foot	4"	6-1/2"	6-1/2"
	PFP-PED-L	Left Straight Edge Pedestal Foot	4"	6-1/8"	1-1/16"
	PFP-PED-R	Right Straight Edge Pedestal Foot	4"	6-1/8"	1-1/16"
MONTEREY SERIES	PFP-PED-2-M	Middle Moulding	3"	16"	15/16"
	PFP-PED-2-C	Pedestal Corner Foot	4"	8-1/4"	8-1/4"
	PFP-PED-2-L	Left Pedestal Foot	4"	8-1/4"	15/16"
	PFP-PED-2-R	Right Pedestal Foot	4"	8-1/4"	15/16"

MONTEREY

PEDESTAL FEET

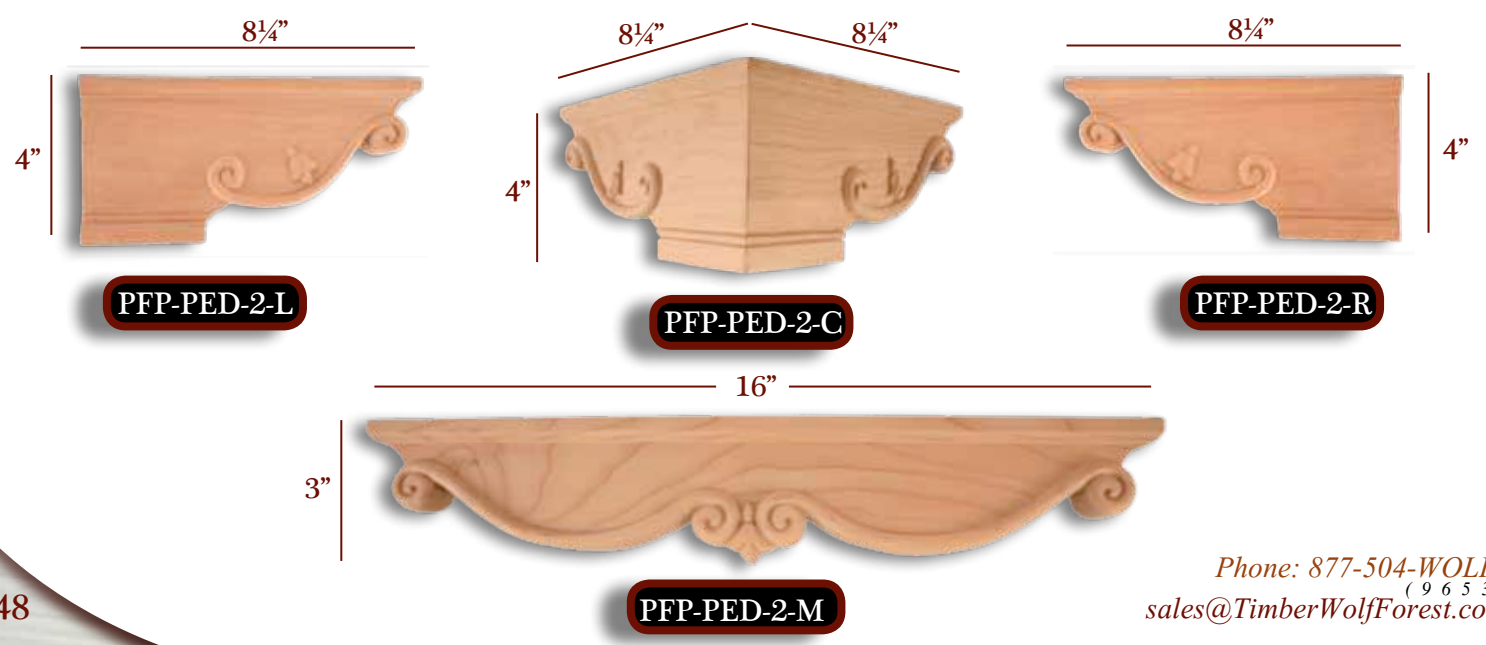

Phone: 877-504-WOLF
 (9 6 5 3)
 sales@TimberWolfForest.com

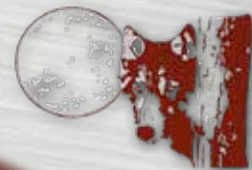

CABINET & FURNITURE

ROUND STYLE

Pedestal & Bun Feet

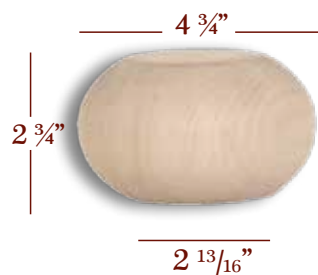

BF900

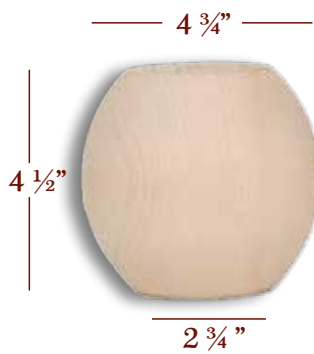

BF901



BF902



BF903



BF910

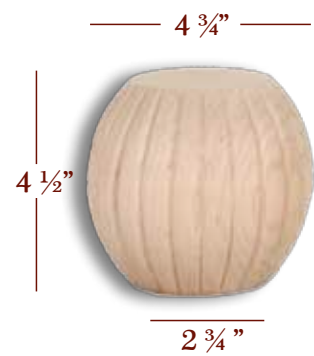

BF911



BF912



BF913

Item No.	Tall	Overall Width	Toe
BF900	2-3/4"	4-3/4"	2-13/16"
BF901	4-1/2"	4-3/4"	2-3/4"
BF902	3"	3-5/8"	1-3/4"
BF903	5-1/2"	3-5/8"	1-1/16"
BF910	2-3/4"	4-3/4"	2-13/16"
BF911	4-1/2"	4-3/4"	2-3/4"
BF912	9-1/8"	3-3/8"	7/8"
BF913	9-1/8"	3-3/8"	7/8"

*Bun Feet available in Alder, Cherry, Maple, Poplar, Red Oak, Rubberwood & White Pine
Other Species upon request*

"Leading the Pack"

CABINET & FURNITURE

ROUND STYLE

Pedestal & Bun Feet



BF916



BF919



BF925



BF930



BF931

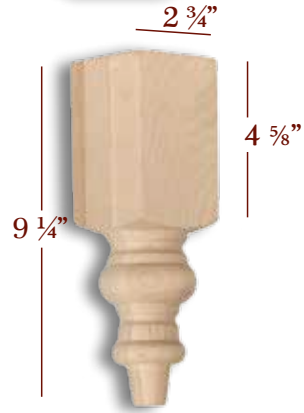

BF940



BF945

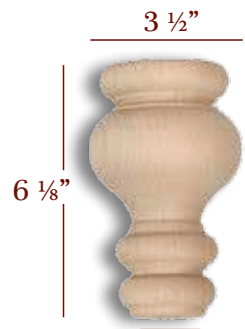

BF950



BF951



BFS41S



BFS41L

*Bun Feet available in Alder, Cherry, Maple, Poplar, Red Oak, Rubberwood & White Pine
Other Species upon request*

Item No.	Tall	Overall Width	Toe
BF916	5-1/2"	3-1/2"	1-1/16"
BF919	4"	3-1/2"	2-1/4"
BF925	4"	4-3/4"	2-5/8"
BF930	5"	4"	7/8"
BF931	4-1/2"	2-3/4"	1-3/8"
BF940	9-1/4"	2-3/4"	13/16"
BF945	5"	3-1/2"	1-5/8"
BF950	6-1/8"	3-1/2"	1-3/8"
BF951	6-1/2"	3-5/8"	1-3/8"
BFS41S	4"	3-1/4"	1-1/2"
BFS41L	4"	4-3/4"	3"

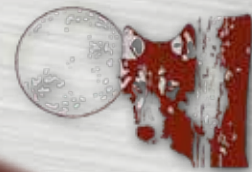

CABINET & FURNITURE FEET

ROUND STYLE

Pedestal & Bun Feet



BF952



BF953



BF960



BF963



BF966



BF975



BF983



BF990



BF-P002



ML1101F

Item No.	Tall	Overall Width	Top Shank Width	Top Shank Length	Toe
BF952	6"	3-1/2"	N/A	N/A	1-1/2"
BF953	5-3/4"	4-3/8"	N/A	N/A	1-1/4"
BF960	4-1/2"	3-1/2"	N/A	N/A	1-1/2"
BF963	4"	3-1/2"	N/A	N/A	1-1/2"
BF966	4"	3-1/2"	N/A	N/A	1-13/16"
BF975	3"	4-3/4"	N/A	N/A	3-13/16"
BF983	4-1/2"	4-1/2"	N/A	N/A	2-1/8"
BF990	3-3/4"	4-3/4"	N/A	N/A	3-1/2"
BF-P002	4"	3-5/8"	N/A	N/A	1-3/16"
ML1101F	11"	2-5/8"	2"	3"	1-1/16"

*Bun Feet available in Alder, Cherry, Maple, Poplar, Red Oak, Rubberwood & White Pine
Other Species upon request*

"Leading the Pack"

CABINET & FURNITURE SQUARE STYLE

Pedestal & Bun Feet

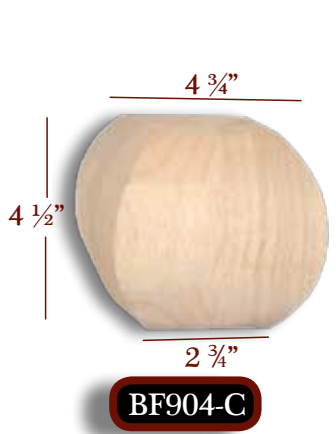
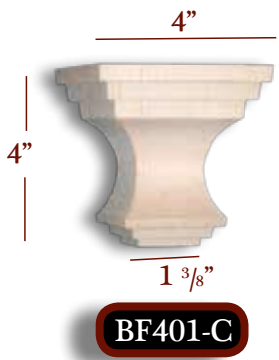

Item No.	Tall	Overall Width	Toe
BFS14S	4"	3-1/2"	2-1/2"
BFS14L	4"	4-3/4"	3-3/4"
BFS22S	4"	2-1/2"	1-1/2"
BFS22L	4"	3-3/4"	2-5/8"
BF401-C	4"	4"	1-3/8"
BF402-C	4"	4-3/4"	2-1/8"
BF403-C	6"	5-1/4"	1-3/8"
BF904-C	4-1/2"	4-3/4"	2-3/4"
BF914-C	9-1/8"	3-1/2"	1"
BF918-C	2-1/8"	4-1/2"	3-5/16"
BF920-C	4"	3-1/2"	2-1/4"

Bun Feet available in Alder, Cherry, Maple, Red Oak, & Rubberwood
Other Species upon request

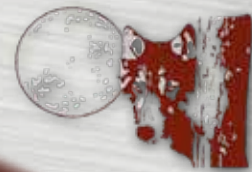

CABINET & FURNITURE FEET

SQUARE STYLE

Pedestal & Bun Feet



BF926-C

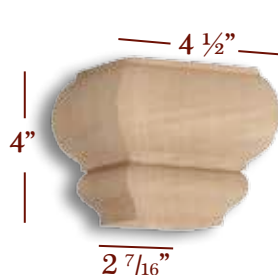

BF927-C



BF928-C

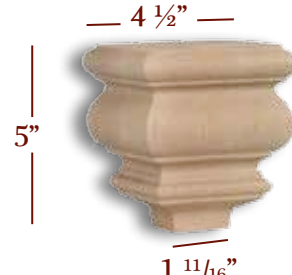

BF929-C



BF958-C



BF959-C



BF961-C



BF962-C



BF965-C

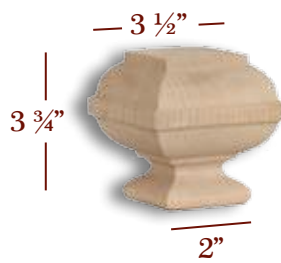

BF992-C

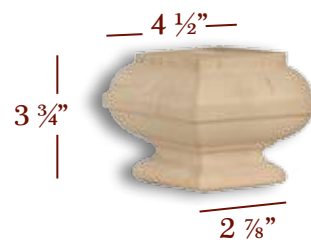

BF993-C

Item No.	Tall	Overall Width	Toe
BF926-C	4"	3-1/2"	1-3/8"
BF927-C	4"	4-1/2"	2-7/16"
BF928-C	5"	4"	1-1/8"
BF929-C	5"	4-1/2"	1-11/16"
BF958-C	4-1/2"	3-1/2"	1-3/4"
BF959-C	4-1/2"	4-5/8"	3"
BF961-C	4"	3-1/2"	1-3/4"
BF962-C	4"	4-5/8"	3"
BF965-C	4"	3-1/2"	2-1/2"
BF992-C	3-3/4"	3-1/2"	2"
BF993-C	3-3/4"	4-1/2"	2-7/8"

*Bun Feet available in Alder, Cherry, Maple, Red Oak, & Rubberwood
Other Species upon request*

"Leading the Pack"

CABINET & FURNITURE FEET

STRAIGHT/TAPER SQUARE STYLE

Pedestal & Bun Feet



Item No.	Tall	Overall Width	Toe
BF801	4-1/4"	2-3/4"	2-3/4"
BF802	3"	3"	2-7/16"
BF803	2-3/4"	3-1/2"	2-1/2"
BF805	4-1/2"	3-1/4"	2-1/2"
BF820	4-1/2"	4-1/2"	3-5/8"
BF821	4-1/2"	3-1/2" X 4-1/2"	2-1/2" X 3-1/2"
BF822	4-1/2"	4-3/4"	4-3/4"

*Bun Feet available in Alder, Cherry, Maple, Red Oak, & Rubberwood
Other Species upon request*

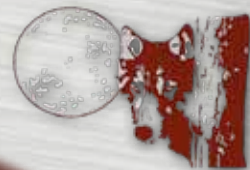

CABINET & FURNITURE FEET

TAPERED PEG LEGS

1 3/4" SQUARE LEGS



*Pictured Left to Right: BF175-125,
BF175-100, BF175-90*

2 1/4" SQUARE LEGS



*Pictured Left to Right: BF225-95,
BF225-80, BF225-55*

Pedestal & Bun Feet

PEG LEGS COME IN A VARIETY OF LENGTHS AS SEEN BELOW.

Item No.	Tall	Overall Width	Toe
BF175-85	8-1/2"	1-3/4"	7/8"
BF175-90	9"	1-3/4"	7/8"
BF175-95	9-1/2"	1-3/4"	7/8"
BF175-100	10"	1-3/4"	7/8"
BF175-115	11-1/2"	1-3/4"	7/8"
BF175-120	12"	1-3/4"	7/8"
BF175-125	12-1/2"	1-3/4"	7/8"
BF225-40	4"	2-1/4"	1-1/8"
BF225-50	5"	2-1/4"	1-1/8"
BF225-55	5-1/2"	2-1/4"	1-1/8"
BF225-60	6"	2-1/4"	1-1/8"
BF225-65	6-1/2"	2-1/4"	1-1/8"
BF225-70	7"	2-1/4"	1-1/8"
BF225-80	8"	2-1/4"	1-1/8"
BF225-85	8-1/2"	2-1/4"	1-1/8"
BF225-90	9"	2-1/4"	1-1/8"
BF225-95	9-1/2"	2-1/4"	1-1/8"
BF225-115	11-1/2"	2-1/4"	1-1/8"

*Pegs available in Cherry, Maple,
Red Oak, & Rubberwood
Other Species upon request*

"Leading the Pack"



CABINET & FURNITURE

QUEEN ANNE & CABRIOLE STYLE

Pedestal & Bun Feet

Item 1: QAN7-CP, Height: 7", Overall Width: 2-3/8", Toe: 1-13/16"

Item 2: QAN-BC-6, Height: 6", Overall Width: 1-7/8", Toe: 2"

Item 3: QAB-BC-6, Height: 6", Overall Width: 3-7/8", Toe: 1-5/8"

Item 4: CAB300-6, Height: 6", Overall Width: 3", Toe: 1-3/8"

Item 5: QAB4, Height: 4", Overall Width: 3-1/4", Toe: 1-1/16"

Item 6: QAB5-1/2, Height: 5-1/2", Overall Width: 3-1/2", Toe: 1-3/16"

Item 7: QAB8-1/2, Height: 8-1/2", Overall Width: 3-1/2", Toe: 1-3/8"

Item 8: QAB10, Height: 10", Overall Width: 4", Toe: 1-3/8"

Item No.	Tall	Overall Width	Toe
QAN7-CP	7"	2-3/4"	1-13/16"
QAN-BC-6	6"	1-7/8"	2"
QAB-BC-6	6"	3-7/8"	1-5/8"
CAB300-6	6"	3"	1-3/8"
QAB4	4"	3-1/4"	1-1/16"
QAB5-1/2	5-1/2"	3-1/2"	1-3/16"
QAB8-1/2"	8-1/2"	3-1/2"	1-3/8"
QAB10	10"	4"	1-3/8"

Queen Anne & Cabriole feet available in Alder, Cherry, Maple, Red Oak, & Rubberwood
Other Species upon request

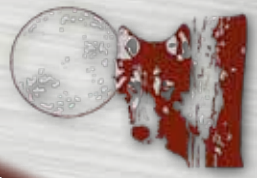

FURNITURE LEGS



KINGSTON SERIES
FL5500-29E
Shown in Picture

"Leading the Pack"

CABRIOLE SERIES

Furniture Legs

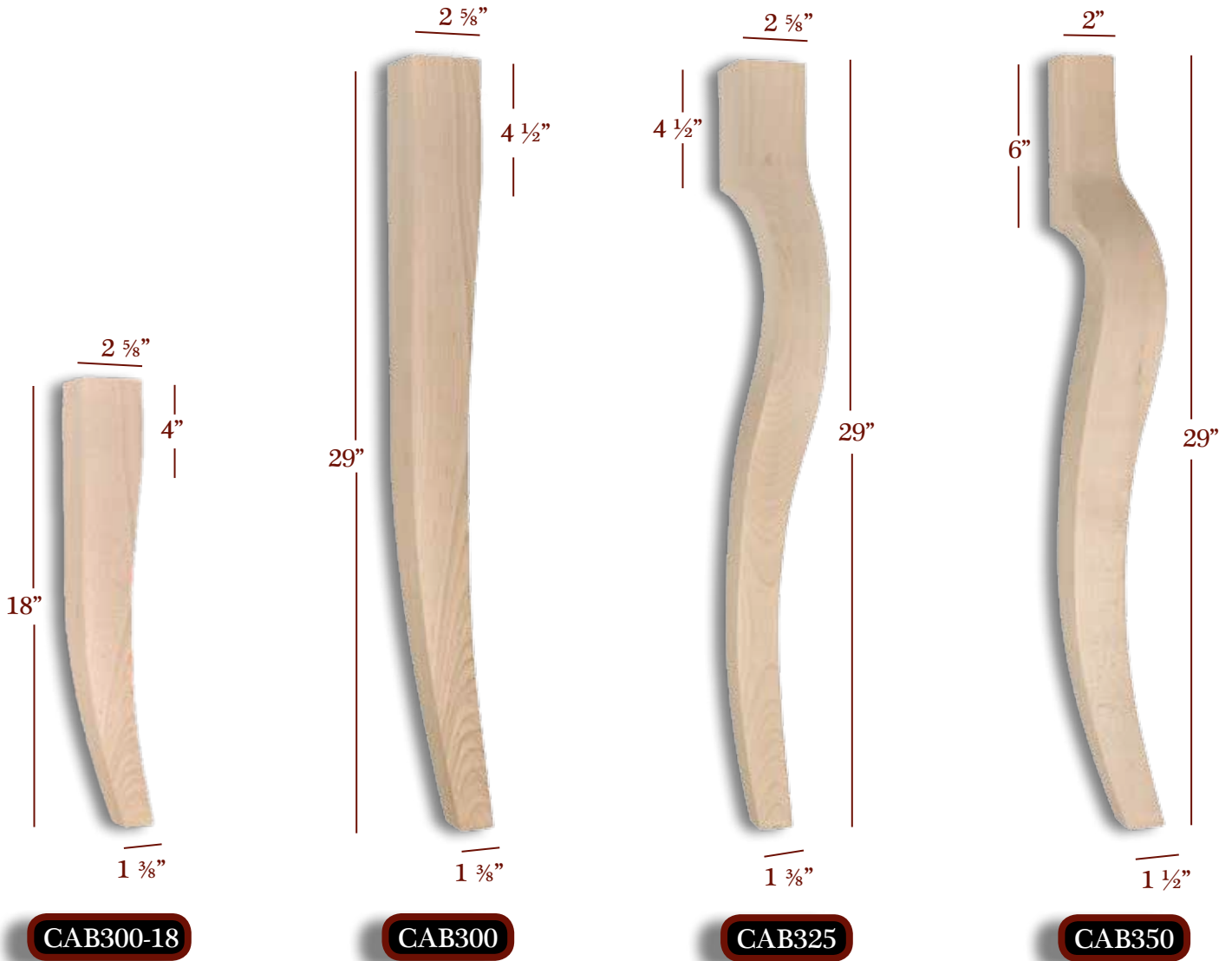

Item No.	Tall	Shank length	Toe	Width of Top
CAB300-18	18"	4"	1-3/8"	2-5/8"
CAB300	29"	4-1/2"	1-3/8"	2-5/8"
CAB325	29"	4-1/2"	1-3/8"	2-5/8"
CAB350	29"	6"	1-1/2"	2"

Cabriole Series is also available in 36" & 6"
See Pages 113, 117, 156, 183 & 184

*Available in Alder, Cherry, Maple, Poplar, Red Oak, Rubberwood & White Pine
 Other Species upon request*

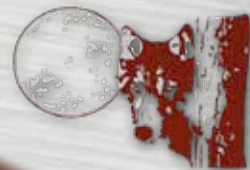

CHARLESTON SERIES

Furniture Legs

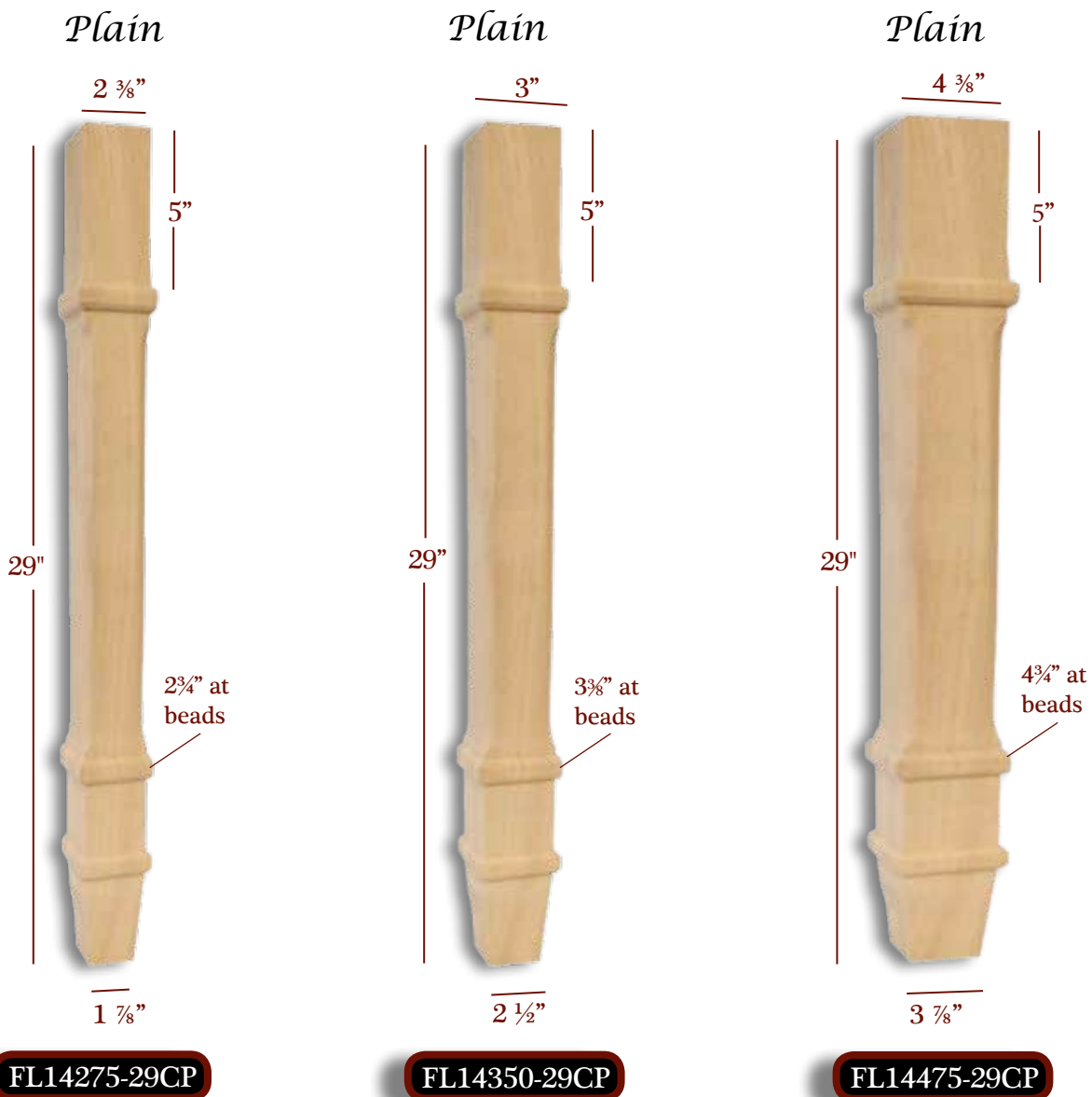

FL14275-29CP

FL14350-29CP

FL14475-29CP

Item No.	Tall	Width at Beads	Shank length	Toe	Width of Top
FL14275-29CP	29"	2-3/4"	8"	1-7/8"	2-3/8"
FL14350-29CP	29"	3-1/2"	8"	2-1/2"	3"
FL14475-29CP	29"	4-3/4"	8"	3-7/8"	4-3/8"

*Charleston Series is also available in 36" & 42"
See Pages 26, 27 & 119*

*Available in Alder, Cherry, Maple,
Poplar, Red Oak & Rubberwood
Other Species upon request*

"Leading the Pack"

COSMO SERIES

Furniture Legs

2 Sided Taper



FL3225-18-2ST

4 Sided Taper

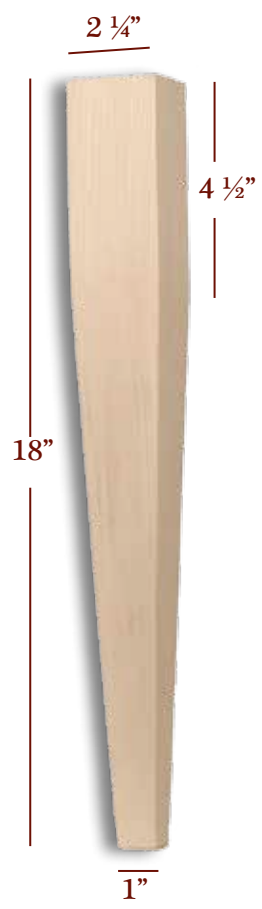

FL3225-18-4ST

2 Sided Taper



FL3275-18-2ST

4 Sided Taper



FL3275-18-4ST

Item No.	Description	Tall	Overall Width	Top Shank Length	Toe
FL3225-18-2ST	2-Sided Taper	18"	2-1/4"	4-1/2"	1"
FL3225-18-4ST	4-Sided Taper	18"	2-1/4"	4-1/2"	1"
FL3275-18-2ST	2-Sided Taper	18"	2-3/4"	5"	1"
FL3275-18-4ST	4-Sided Taper	18"	2-3/4"	5"	1"

Cosmo Series is also available in 21", 29", 36" & 42"
See Pages 28, 113, 120, 161 & 162

Available in Alder, Cherry, Maple, Poplar, Red Oak, Rubberwood & White Pine
Other Species upon request

American Made

Phone: 877-504-WOLF
(9653)
sales@TimberWolfForest.com

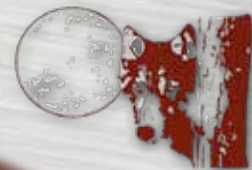

COSMO SERIES

2 Sided Taper



FL3225-21-2ST

4 Sided Taper



FL3225-21-4ST

2 Sided Taper



FL3275-21-2ST

4 Sided Taper



FL3275-21-4ST

Furniture Legs

Item No.	Description	Tall	Overall Width	Top Shank Length	Toe
FL3225-21-2ST	2-Sided Taper	21"	2-1/4"	4-1/2"	1"
FL3225-21-4ST	4-Sided Taper	21"	2-1/4"	4-1/2"	1"
FL3275-21-2ST	2-Sided Taper	21"	2-3/4"	5"	1"
FL3275-21-4ST	4-Sided Taper	21"	2-3/4"	5"	1"

Cosmo Series is also available in 18", 29", 36" & 42"
See Pages 28, 113, 120, 160 & 162

*Available in Alder, Cherry, Maple, Poplar, Red Oak, Rubberwood & White Pine
 Other Species upon request*

"Leading the Pack"

COSMO SERIES

Furniture Legs

2 Sided Taper



FL3275-29-2ST

2 Sided Taper



FL3375-29-2ST

4 Sided Taper

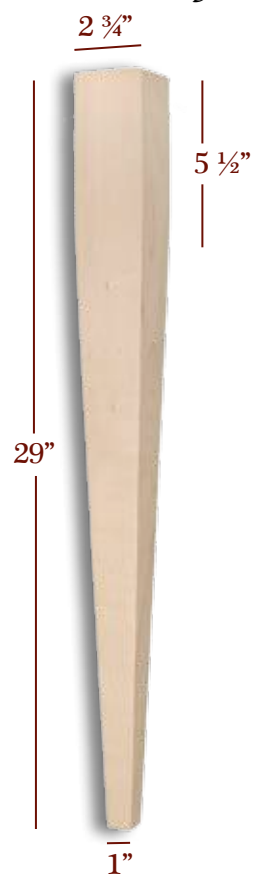

FL3275-29-4ST

4 Sided Taper



FL3375-29-4ST

Item No.	Description	Tall	Overall Width	Top Shank Length	Toe
FL3275-29-2ST	2-Sided Taper	29"	2-3/4"	5-1/2"	1"
FL3275-29-4ST	4-Sided Taper	29"	2-3/4"	5-1/2"	1"
FL3375-29-2ST	2-Sided Taper	29"	3-3/4"	6"	2-1/4"
FL3375-29-4ST	4-Sided Taper	29"	3-3/4"	6"	2-1/4"

Cosmo Series is also available in 18", 21", 36" & 42"
See Pages 28, 113, 120, 160 & 161

*Available in Alder, Cherry, Maple, Poplar, Red Oak, Rubberwood & White Pine
 Other Species upon request*

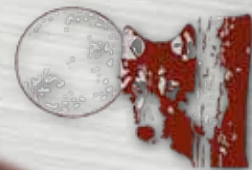

GEORGIAN SERIES

Plain

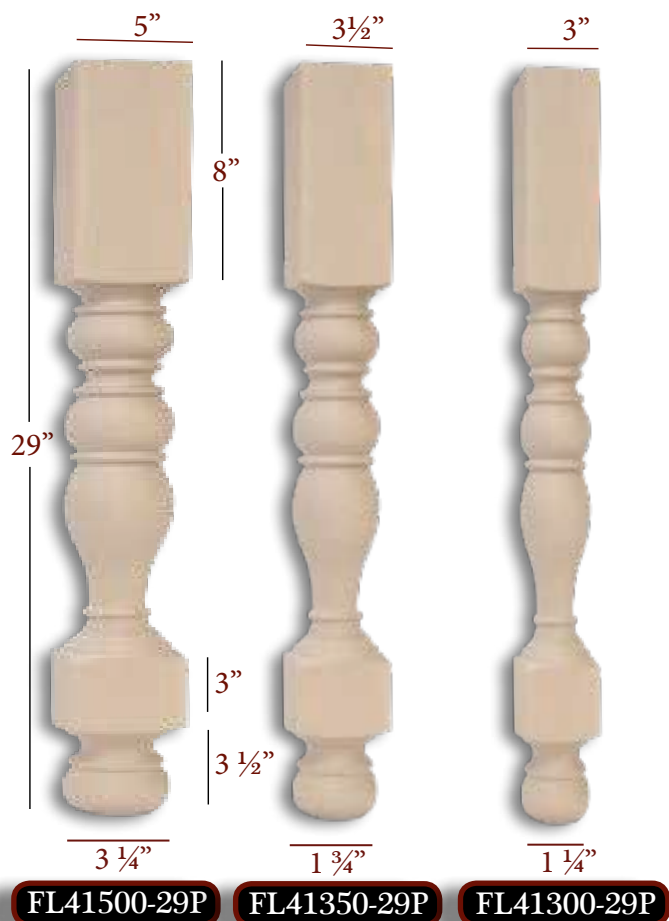

FL41500-29P

FL41350-29P

FL41300-29P

Georgian Series is also available in 36"
See Pages 42, 124 & 143

Available in Alder, Cherry, Maple, Poplar, Red Oak, Rubberwood & White Pine
Other Species upon request

DELLINGER SERIES

Plain

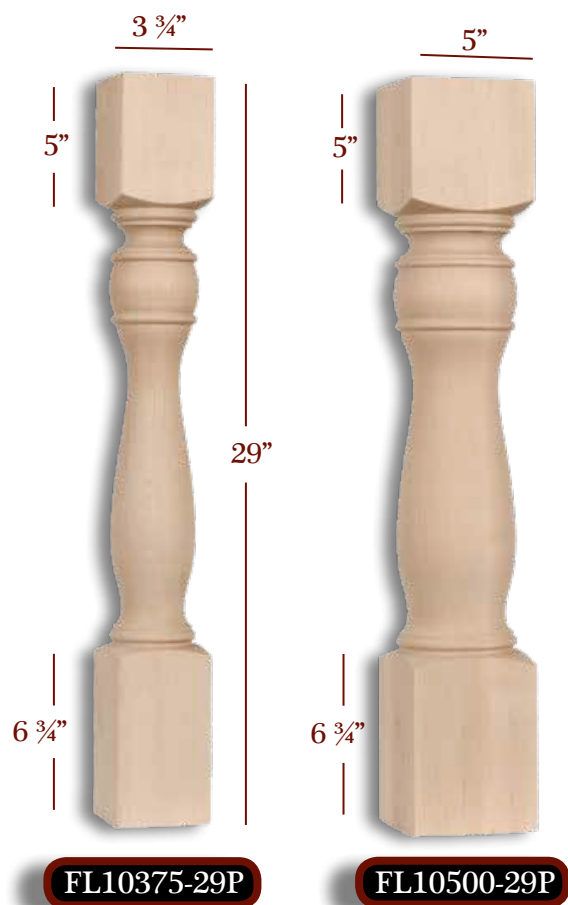

FL10375-29P

FL10500-29P

Dellinger Series is also available in 36"
See Pages 30 & 121

Furniture Legs

Item No.	Tall	Width	Top Shank Length	Bottom Shank Length	Block	Toe
FL10375-29P	29"	3-3/4"	5"	6-3/4"	N/A	N/A
FL10500-29P	29"	5"	5"	6-3/4"	N/A	N/A
FL41300-29P	29"	3"	8"	N/A	3"	1-1/4"
FL41350-29P	29"	3-1/2"	8"	N/A	3"	1-3/4"
FL41500-29P	29"	5"	8"	N/A	3"	3-1/4"

"Leading the Pack"

HAMILTON SERIES

Furniture Legs



Item No.	Description	Tall	Overall Width	Top Shank Length	Toe
FL4225-18E	Reeded	18"	2-1/4"	5-1/2"	1"
FL4225-18P	Plain	18"	2-1/4"	5-1/2"	1"
FL4225-18R	Roped	18"	2-1/4"	5-1/2"	1"

*Hamilton Series is also available
in 21", 29" & 36"
See Pages 44, 124, 165 & 166*

*Available in Alder, Cherry, Maple,
Poplar, Red Oak, Rubberwood & White Pine
Other Species upon request*

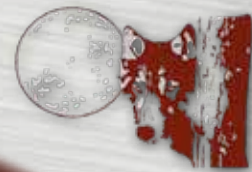

HAMILTON SERIES

Furniture Legs

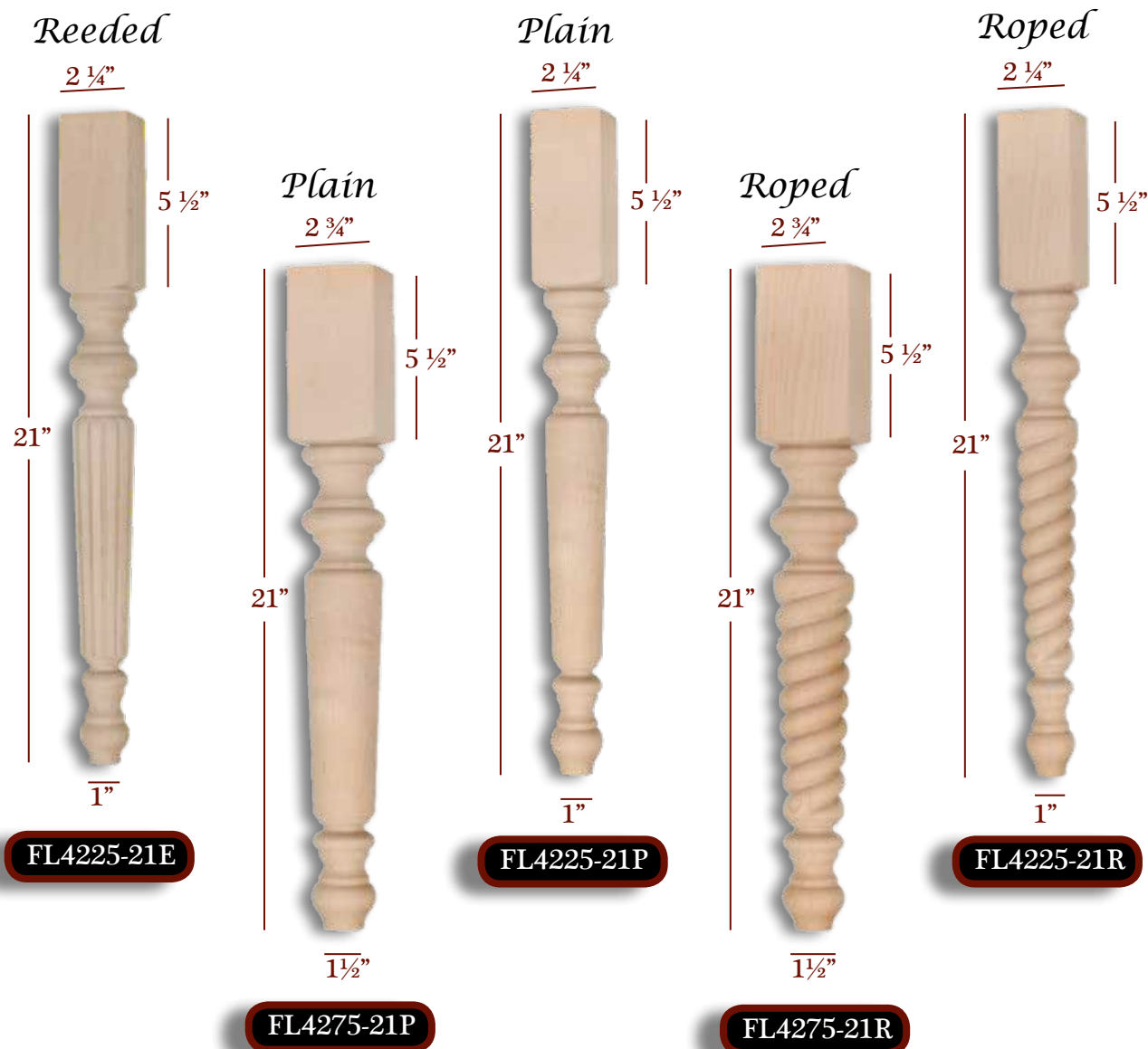

Item No.	Description	Tall	Width	Top Shank Length	Toe
FL4225-21E	Reeded	21"	2-1/4"	5-1/2"	1"
FL4225-21P	Plain	21"	2-1/4"	5-1/2"	1"
FL4225-21R	Roped	21"	2-1/4"	5-1/2"	1"
FL4275-21P	Plain	21"	2-3/4"	5-1/2"	1-1/2"
FL4275-21R	Roped	21"	2-3/4"	5-1/2"	1-1/2"

*Hamilton Series is also available in
18", 29" & 36"
See Pages 44, 124, 164 & 166*

*Available in Alder, Cherry, Maple,
Poplar, Red Oak, Rubberwood & White Pine
Other Species upon request*

"Leading the Pack"

HAMILTON SERIES

Furniture Legs

Reeded

$2\frac{3}{4}"$

$5\frac{1}{2}"$

29"

$1\frac{1}{8}"$

FL4275-29E

Plain

$2\frac{3}{4}"$

$5\frac{1}{2}"$

29"

$1\frac{1}{8}"$

FL4275-29P

Roped

$2\frac{3}{4}"$

$5\frac{1}{2}"$

29"

$1\frac{1}{8}"$

FL4275-29R

Roped

$3\frac{3}{4}"$

$5\frac{1}{2}"$

29"

$1\frac{5}{8}"$

FL4375-29R

Item No.	Description	Tall	Overall Width	Top Shank Length	Toe
FL4275-29E	Reeded	29"	2-3/4"	5-1/2"	1-1/8"
FL4275-29P	Plain	29"	2-3/4"	5-1/2"	1-1/8"
FL4275-29R	Roped	29"	2-3/4"	5-1/2"	1-1/8"
FL4375-29R	Roped	29"	3-3/4"	5-1/2"	1-5/8"

*Hamilton Series is also available in
18", 21" & 36"
See Pages 44, 124, 164 & 165*

*Available in Alder, Cherry, Maple,
Poplar, Red Oak, Rubberwood & White Pine
Other Species upon request*



American Made



Phone: 877-504-WOLF
(9653)
sales@TimberWolfForest.com

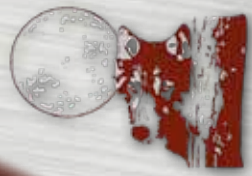

HARVEST SERIES

Furniture Legs

Plain



FL2275-18P

Fluted



FL2375-18F

Plain



FL2375-18P



Item No.	Description	Tall	Overall Width	Top Shank Length	Toe
FL2275-18P	Plain	18"	2-3/4"	6-1/2"	1-1/8"
FL2375-18F	Fluted	18"	3-3/4"	6-1/2"	2"
FL2375-18P	Plain	18"	3-3/4"	6-1/2"	2"

*Available in Alder, Cherry, Maple,
Poplar, Red Oak, Rubberwood & White Pine
Other Species upon request*

*Harvest Series is also available in
21", 29", 36" & 42"
See Pages 46, 125, 168, 169 & 170*

"Leading the Pack"

HARVEST SERIES



FL2375-29P
Shown in Picture

Furniture Legs

Plain



FL2275-21P

Fluted



FL2375-21F

Plain



FL2375-21P

Item No.	Description	Tall	Overall Width	Top Shank Length	Toe
FL2275-21P	Plain	21"	2-3/4"	6-1/2"	1-1/8"
FL2375-21F	Fluted	21"	3-3/4"	6-1/2"	2-1/4"
FL2375-21P	Plain	21"	3-3/4"	6-1/2"	2-1/4"

Available in Alder, Cherry, Maple,
Poplar, Red Oak, Rubberwood & White Pine
Other Species upon request

Harvest Series is also available in
18", 29", 36" & 42"
See Pages 46, 125, 167, 169 & 170

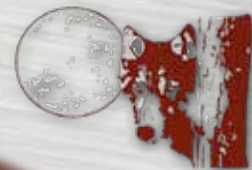

HARVEST SERIES

Furniture Legs

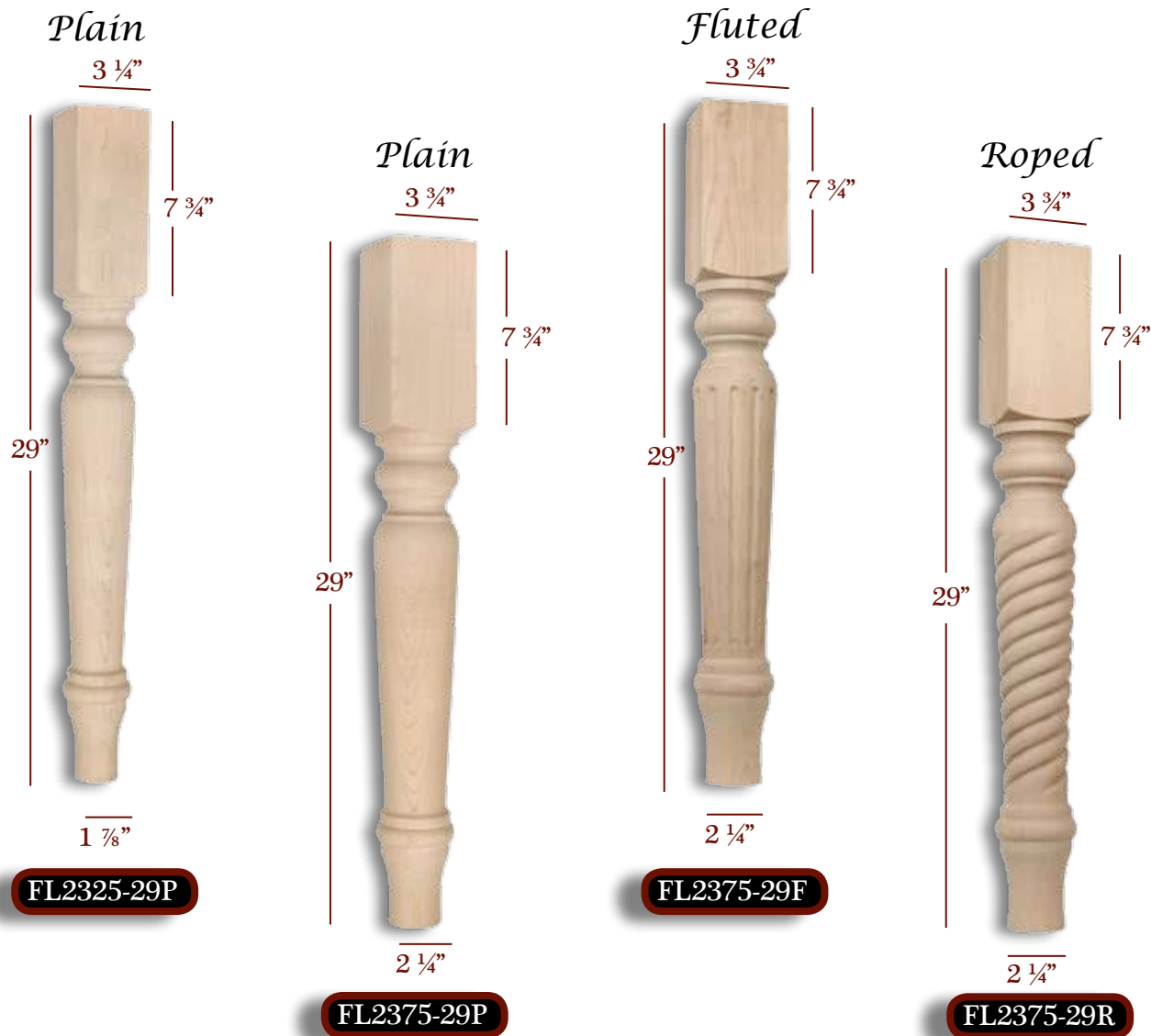

Item No.	Description	Tall	Overall Width	Top Shank Length	Toe
FL2325-29P	Plain	29"	3-1/4"	7-3/4"	1-7/8"
FL2375-29P	Plain	29"	3-3/4"	7-3/4"	2-1/4"
FL2375-29F	Fluted	29"	3-3/4"	7-3/4"	2-1/4"
FL2375-29R	Roped	29"	3-3/4"	7-3/4"	2-1/4"

*Harvest Series is also available in
18", 21", 36" & 42"
See Pages 46, 125, 167, 168 & 170*

*Available in Alder, Cherry, Maple,
Poplar, Red Oak, Rubberwood & White Pine
Other Species upon request*

"Leading the Pack"

HARVEST SERIES

Furniture Legs



Item No.	Description	Tall	Overall Width	Top Shank Length	Toe
FL2500-29F	Fluted	29"	5"	7-3/4"	3-1/8"
FL2500-29P	Plain	29"	5"	7-3/4"	3-1/8"
FL2500-29R	Roped	29"	5"	7-3/4"	3-1/8"

Harvest Series is also available in 18", 21", 36" & 42"
See Pages 46, 125, 167, 168 & 169

*Available in Alder, Cherry, Maple, Poplar, Red Oak, Rubberwood & White Pine
 Other Species upon request*

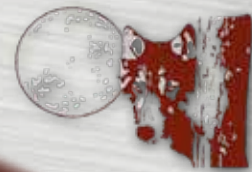

JAMESTOWN SERIES

Furniture Legs

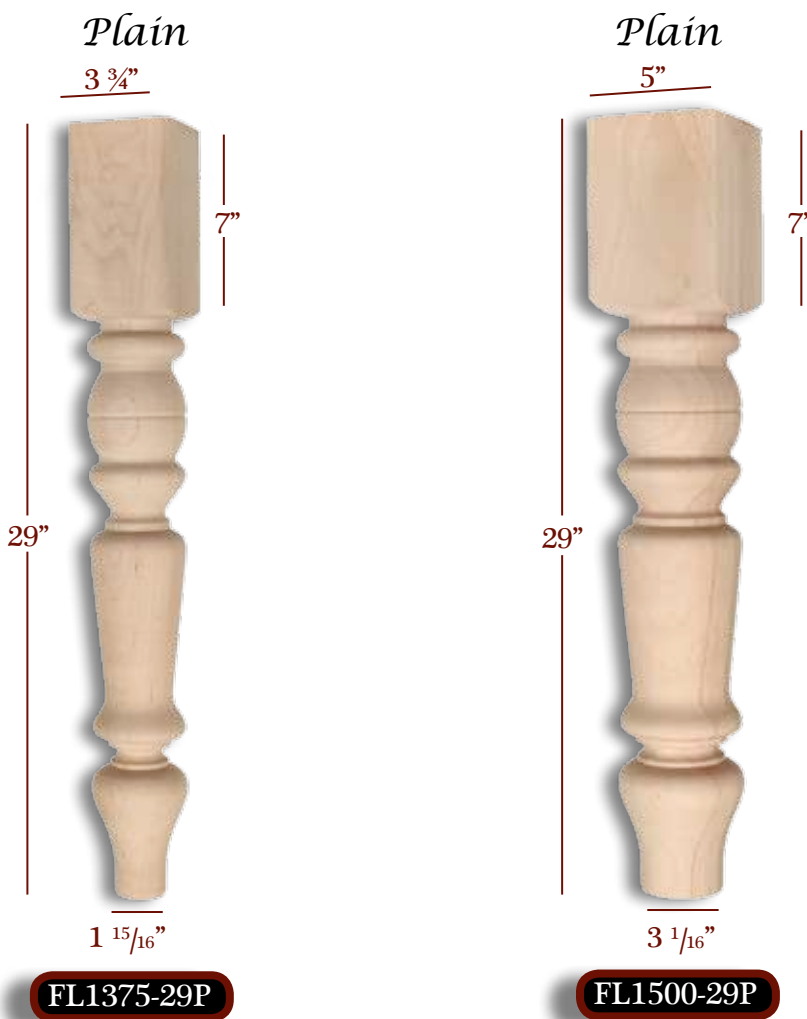

Item No.	Description	Tall	Overall Width	Top Shank Length	Toe
FL1375-29P	Plain	29"	3-3/4"	7"	1-15/16"
FL1500-29P	Plain	29"	5"	7"	3-1/16"

*Jamestown Series is also available in 36"
See Pages 48 & 126*

*Available in Alder, Cherry, Maple,
Poplar, Red Oak, Rubberwood & White Pine
Other Species upon request*



ISL1375P
Shown in Picture

"Leading the Pack"

KINGSTON SERIES

Furniture Legs

Reeded

Plain



*Kingston Series is also available in 36"
See Pages 52 & 127*

Item No.	Description	Tall	Overall Width	Top Shank Length	Toe
FL5500-29E	Reeded	29"	5"	4-1/8"	2-1/8"
FL5500-29P	Plain	29"	5"	4-1/8"	2-1/8"

*Available in Alder, Cherry, Maple,
Poplar, Red Oak, Rubberwood & White Pine
Other Species upon request*

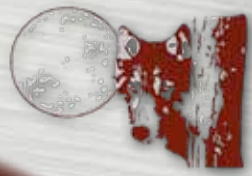

LINCOLN SERIES

Plain

Fluted

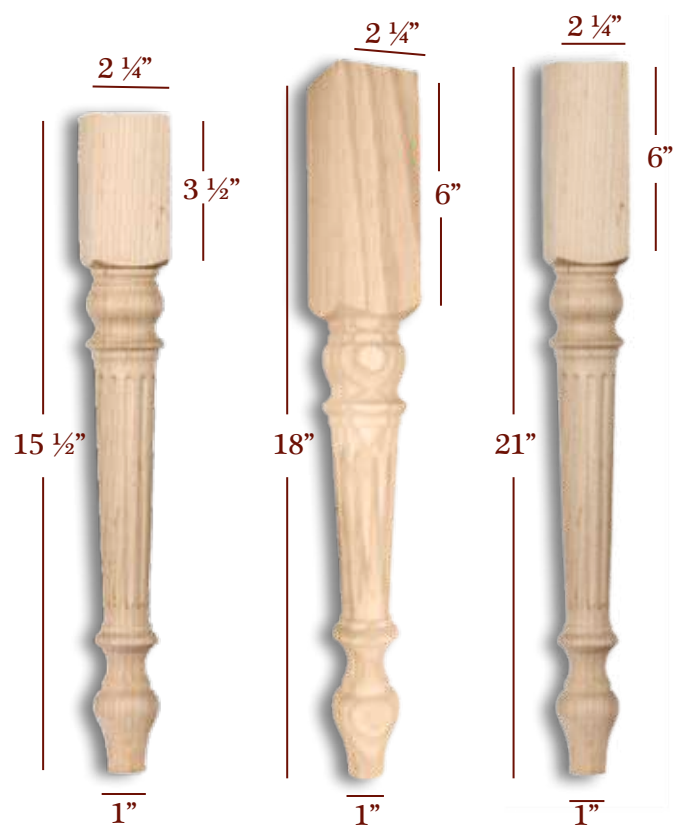
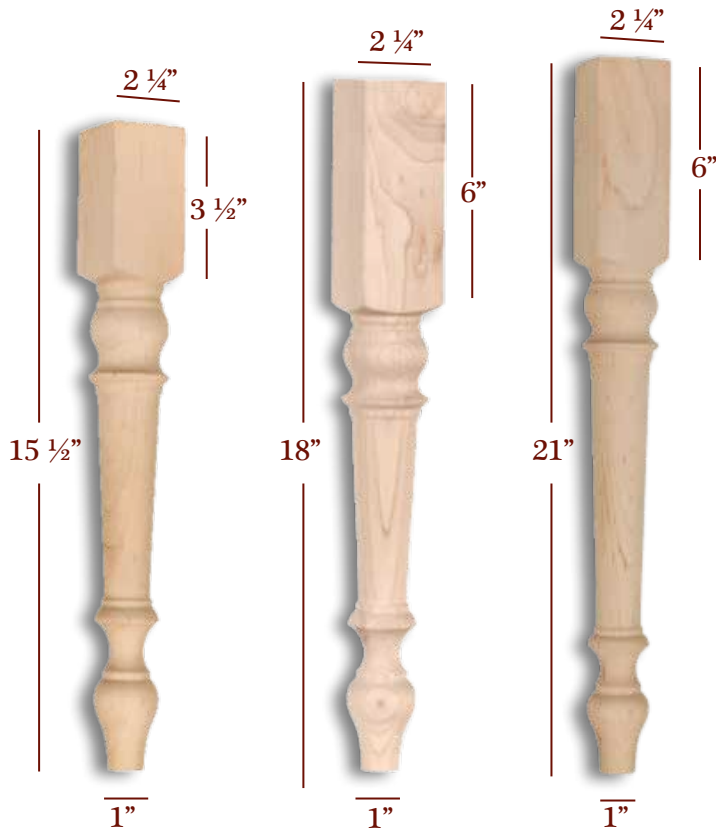

Furniture Legs

FL6225-15-1/2P

FL6225-18P

FL6225-21P

FL6225-15-1/2F

FL6225-18F

FL6225-21F

*Lincoln Series is also available in
29, 36" & 42"
See Pages 58, 129, 174 & 175*

Item No.	Description	Tall	Overall Width	Top Shank Length	Toe
FL6225-15-1/2P	Plain	15-1/2"	2-1/4"	3-1/2"	1"
FL6225-18P	Plain	18"	2-1/4"	6"	1"
FL6225-21P	Plain	21"	2-1/4"	6"	1"
FL6225-15-1/2F	Fluted	15-1/2"	2-1/4"	3-1/2"	1"
FL6225-18F	Fluted	18"	2-1/4"	6"	1"
FL6225-21F	Fluted	21"	2-1/4"	6"	1"



FL6225-21P
Shown in Picture

*Available in Alder, Cherry, Maple,
Poplar, Red Oak, Rubberwood & White Pine
Other Species upon request*

"Leading the Pack"

FL6225-21P
Shown in Picture



LINCOLN SERIES

Furniture Legs

Fluted

2 3/4"

6"

29"

1 1/2"

FL6275-29F

Plain

2 3/4"

6"

29"

1 1/2"

FL6275-29P

Diamond

3 3/4"

6"

29"

2 3/8"

FL6375-29D

Reeded

3 3/4"

6"

29"

2 3/8"

FL6375-29E

Plain

3 3/4"

6"

29"

2 3/8"

FL6375-29P

Item No.	Description	Tall	Overall Width	Top Shank Length	Toe
FL6275-29F	Fluted	29"	2-3/4"	6"	1-1/2"
FL6275-29P	Plain	29"	2-3/4"	6"	1-1/2"
FL6375-29D	Diamond	29"	3-3/4"	6"	2-3/8"
FL6375-29E	Reeded	29"	3-3/4"	6"	2-3/8"
FL6375-29P	Plain	29"	3-3/4"	6"	2-3/8"

Lincoln Series is also available in 15-1/2", 18", 21", 36" & 42"
See Pages 58, 129, 173 & 175

*Available in Alder, Cherry, Maple, Poplar, Red Oak, Rubberwood & White Pine
Other Species upon request*

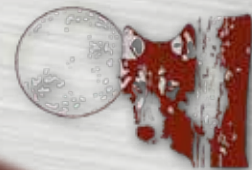

LINCOLN SERIES

Diamond

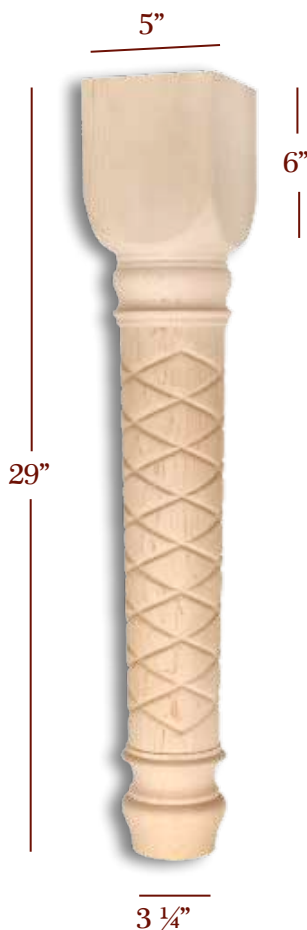

FL6500-29D

Reeded



FL6500-29E

Plain



FL6500-29P

Furniture Legs

*Lincoln Series is also available in
15-1/2, 18, 21, 36" & 42"
See Pages 58, 129, 173 & 174*

Item No.	Description	Tall	Overall Width	Top Shank Length	Toe
FL6500-29D	Diamond	29"	5"	6"	3-1/4"
FL6500-29E	Reeded	29"	5"	6"	3-1/4"
FL6500-29P	Plain	29"	5"	6"	3-1/4"

*Available in Alder, Cherry, Maple,
Poplar, Red Oak, Rubberwood & White Pine
Other Species upon request*



FL6375-29D
Shown in Picture

"Leading the Pack"

MONTE CRISTO SERIES

Furniture Legs

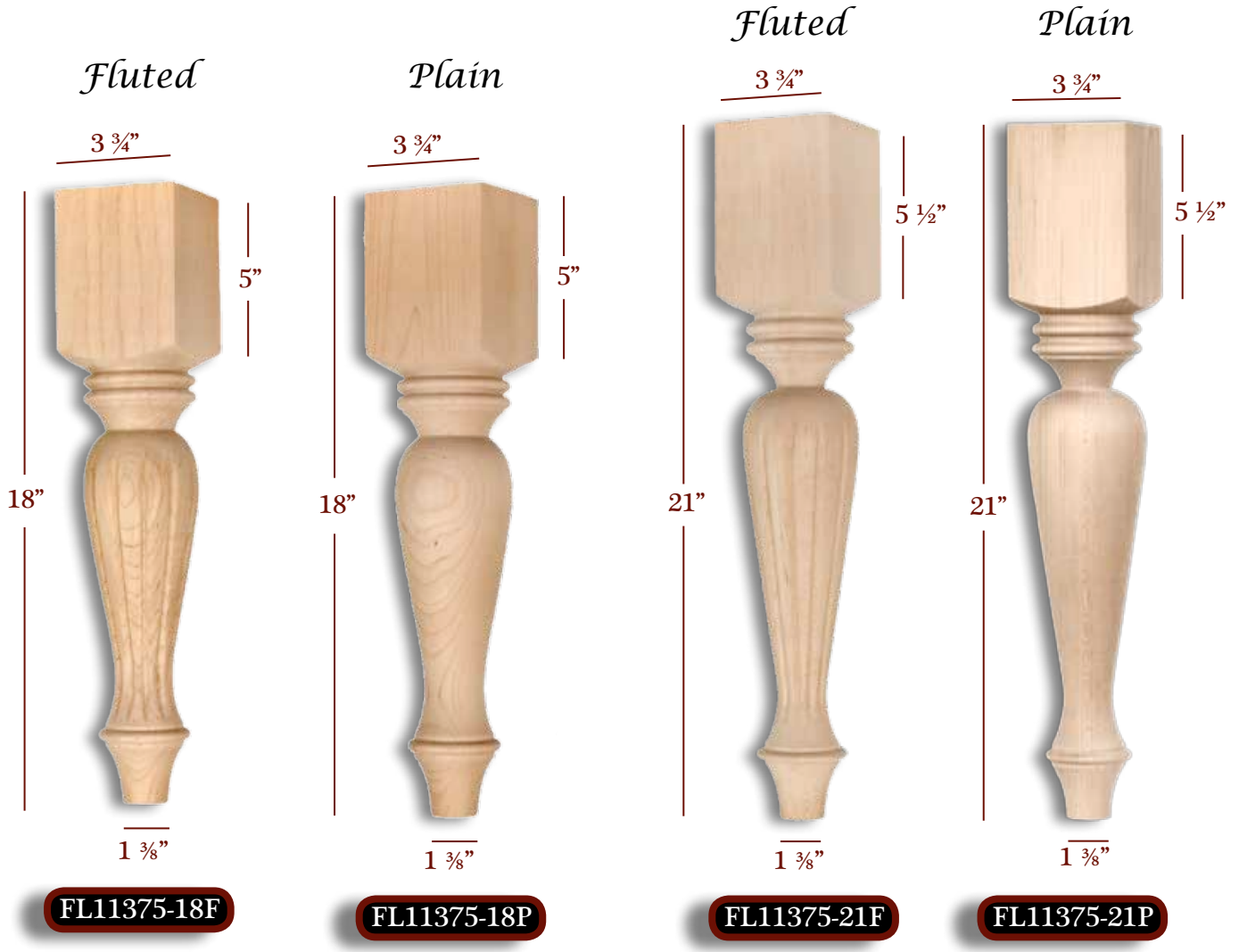

Item No.	Description	Tall	Overall Width	Top Shank Length	Toe
FL11375-18F	Fluted	18"	3-3/4"	5"	1-3/8"
FL11375-18P	Plain	18"	3-3/4"	5"	1-3/8"
FL11375-21F	Fluted	21"	3-3/4"	5-1/2"	1-3/8"
FL11375-21P	Plain	21"	3-3/4"	5-1/2"	1-3/8"

Monte Cristo Series is also available in 29, & 36" See Pages 68, 132 & 177

Available in Alder, Cherry, Maple, Poplar, Red Oak, Rubberwood & White Pine Other Species upon request

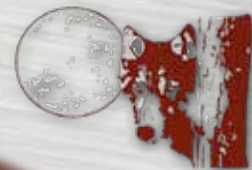

MONTE CRISTO SERIES

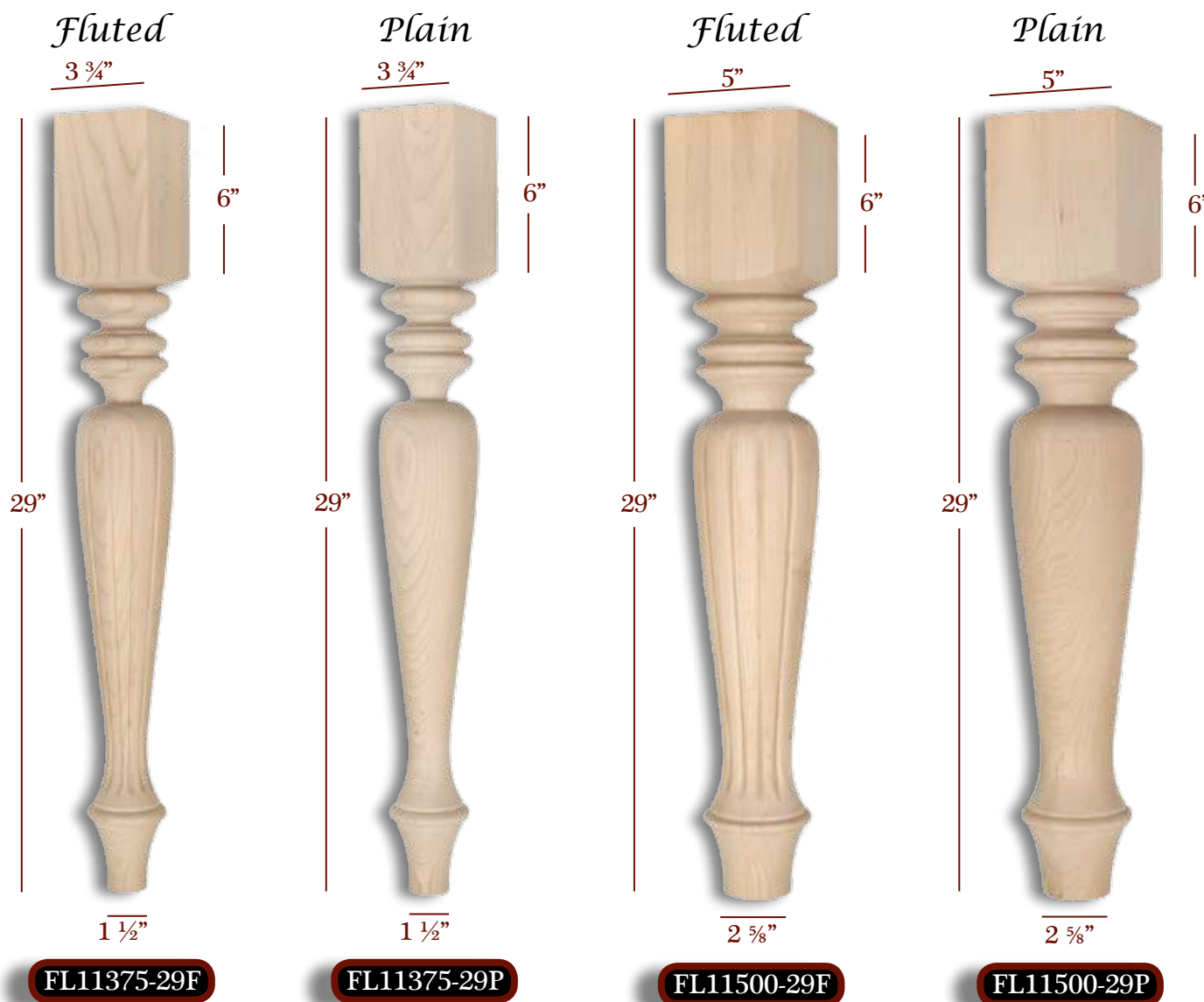

Furniture Legs

Item No.	Description	Tall	Overall Width	Top Shank Length	Toe
FL11375-29F	Fluted	29"	3-3/4"	6"	1-1/2"
FL11375-29P	Plain	29"	3-3/4"	6"	1-1/2"
FL11500-29F	Fluted	29"	5"	6"	2-5/8"
FL11500-29P	Plain	29"	5"	6"	1-3/8"

Monte Cristo Series is also available in 29, & 36" See Pages 68, 132 & 176

Available in Alder, Cherry, Maple, Poplar, Red Oak, Rubberwood & White Pine Other Species upon request

"Leading the Pack"

SALEM SERIES

Furniture Legs

Fluted



FL19375-29F

Plain



FL19375-29P

Fluted



FL19500-29F

Plain



FL19500-29P

Item No.	Description	Tall	Overall Width	Top Shank Length	Block	Toe
FL19375-29F	Fluted	29"	3-3/4"	5"	2-3/4"	2-1/2"
FL19375-29P	Plain	29"	3-3/4"	5"	2-3/4"	2-1/2"
FL19500-29F	Fluted	29"	5"	5"	2-3/4"	3-1/2"
FL19500-29P	Plain	29"	5"	5"	2-3/4"	3-1/2"

Available in Alder, Cherry, Maple,
Poplar, Red Oak, Rubberwood & White Pine
Other Species upon request

Salem Series is also
available in 36"
See Pages 74 & 134

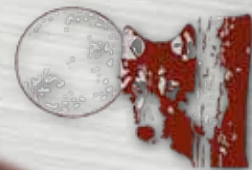

SANTA FE SERIES

Furniture Legs

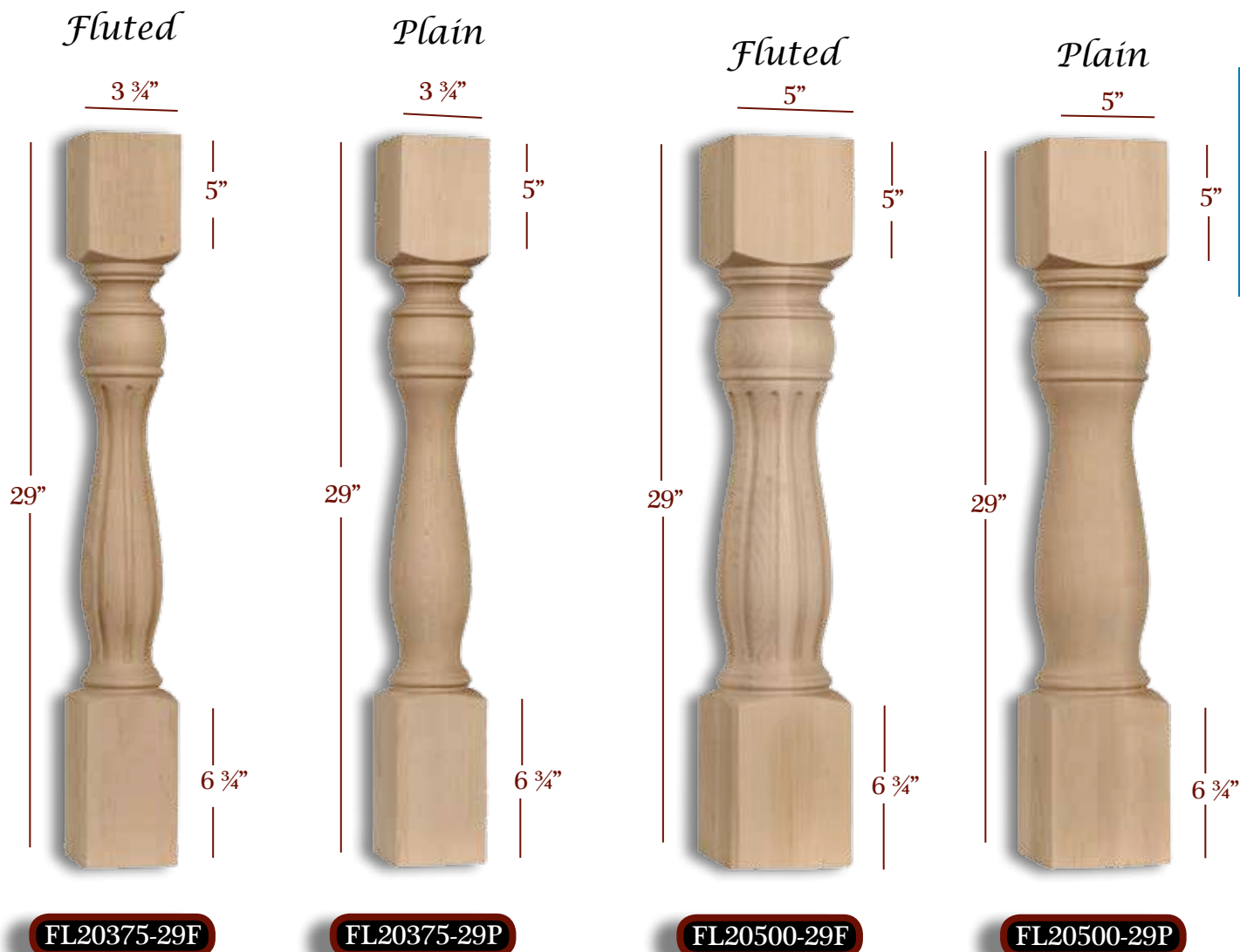

Item No.	Description	Tall	Overall Width	Top Shank Length	Bottom Shank Length
FL20375-29F	Fluted	29"	3-3/4"	5"	6-3/4"
FL20375-29P	Plain	29"	3-3/4"	5"	6-3/4"
FL20500-29F	Fluted	29"	5"	5"	6-3/4"
FL20500-29P	Plain	29"	5"	5"	6-3/4"

*Available in Alder, Cherry, Maple,
Poplar, Red Oak, Rubberwood & White Pine
Other Species upon request*

*Santa Fe Series is also
available in 36" & 42"
See Pages 76 & 135*

"Leading the Pack"

SAVANNAH SERIES

Furniture Legs

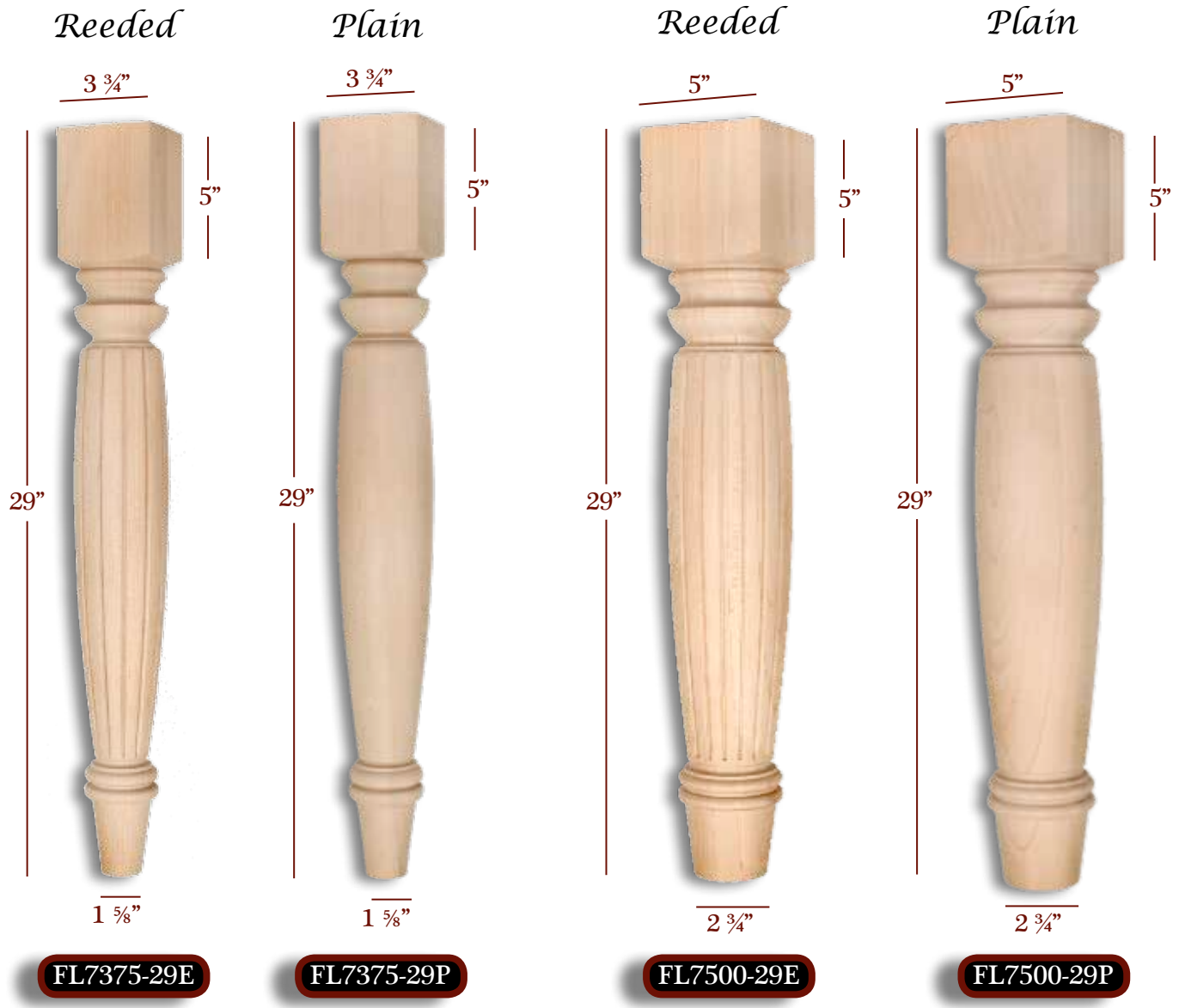

Item No.	Description	Tall	Overall Width	Top Shank Length	Toe
FL7375-29E	Reeded	29"	3-3/4"	5"	1-5/8"
FL7375-29P	Plain	29"	3-3/4"	5"	1-5/8"
FL7500-29E	Reeded	29"	5"	5"	2-3/4"
FL7500-29P	Plain	29"	5"	5"	2-3/4"

Savannah Series is also available in 36" See Pages 78 & 136

Available in Alder, Cherry, Maple, Poplar, Red Oak, & Rubberwood Other Species upon request

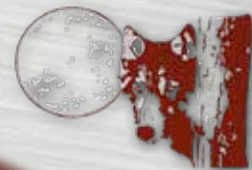

WINSTON SERIES

Furniture Legs

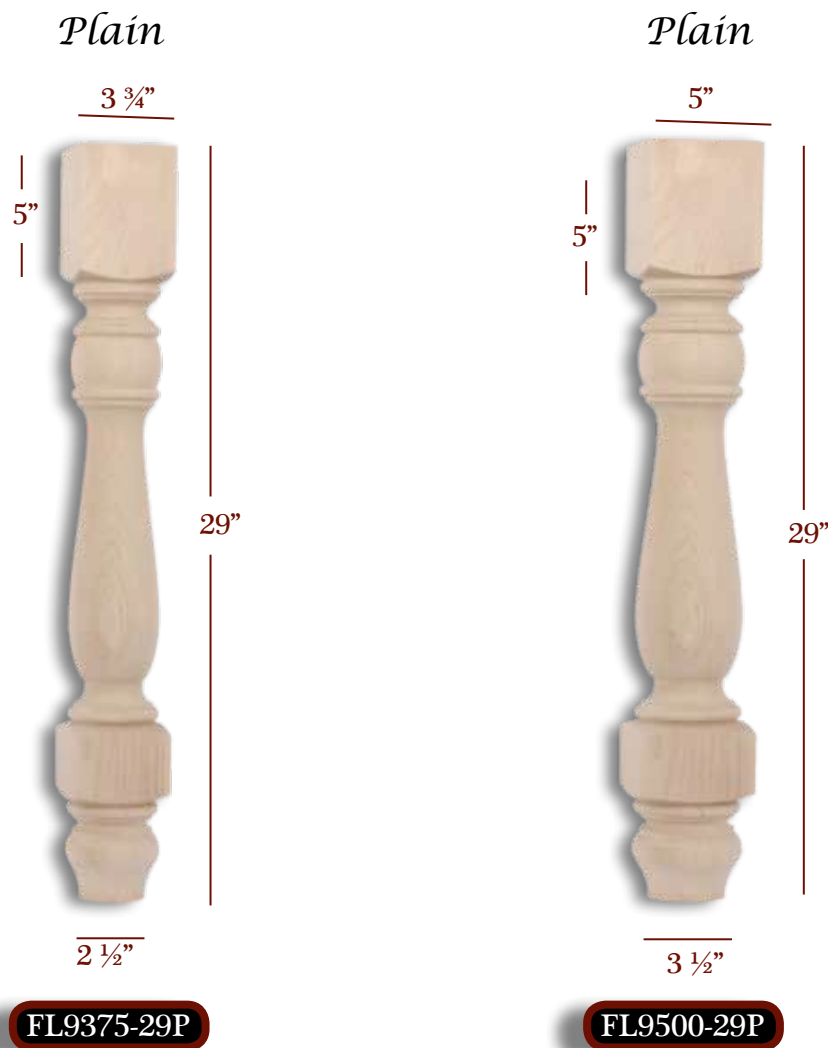

*Available in Alder, Cherry, Maple,
Poplar, Red Oak, Rubberwood & White Pine
Other Species upon request*

Item No.	Description	Tall	Overall Width	Top Shank Length	Toe
FL9375-29P	Plain	29"	3-3/4"	5"	2-1/2"
FL9500-29P	Plain	29"	5"	5"	3-1/2"

*Winston Series is also
available in 36"
See Pages 90, 140 & 143*

"Leading the Pack"

CABRIOLE & QUEEN ANNE LEGS



CAB350
Shown in Picture

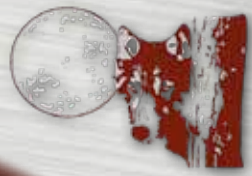

CABRIOLE SERIES

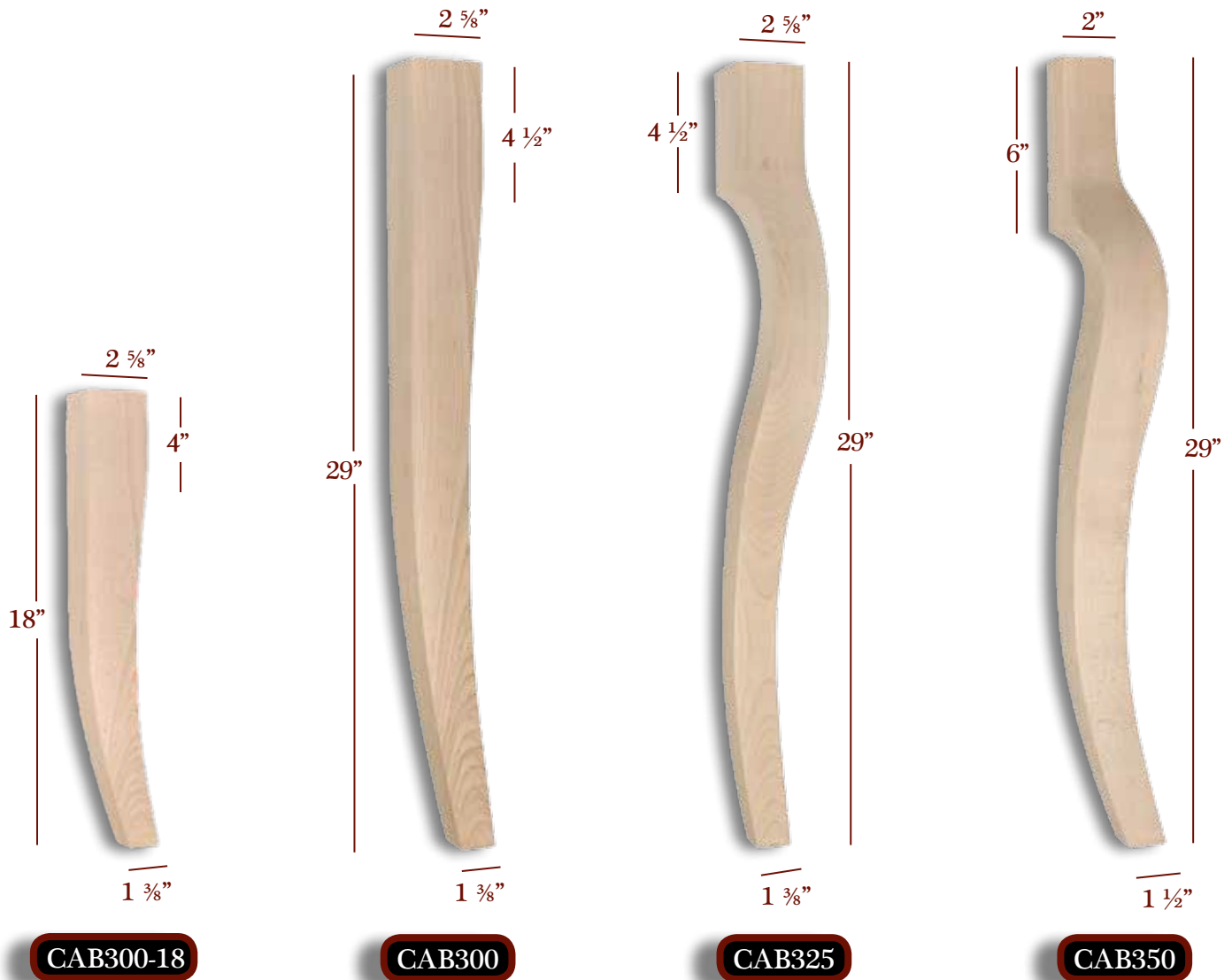

Cabriole & Queen Anne Legs

Item No.	Tall	Shank length	Toe	Width of Top
CAB300-18	18"	4"	1-3/8"	2-5/8"
CAB300	29"	4-1/2"	1-3/8"	2-5/8"
CAB325	29"	4-1/2"	1-3/8"	2-5/8"
CAB350	29"	6"	1-1/2"	2"

*Cabriole Series is also available in 36" & 6"
See Pages 113, 117, 156 & 184*

*Available in Alder, Cherry, Maple, Poplar, Red Oak, Rubberwood & White Pine
Other Species upon request*

"Leading the Pack"

CABRIOLE SERIES

Cabriole & Queen Anne Legs



CAB350
Shown in Picture



CAB300-6

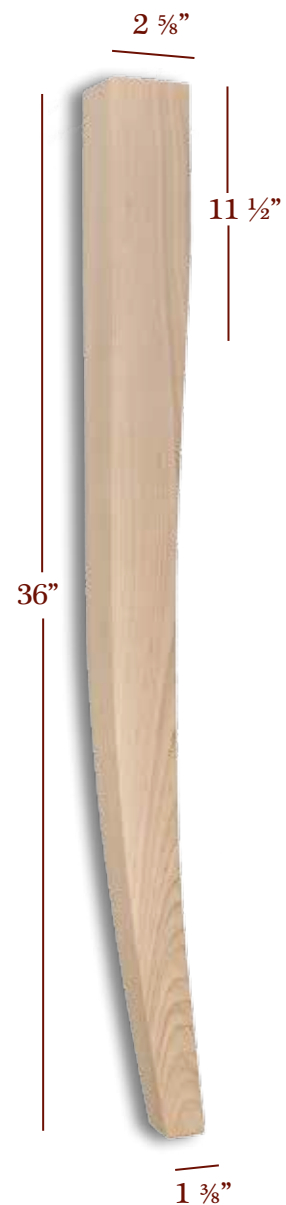

CAB300-36



CAB350-36

Item No.	Tall	Shank length	Toe	Width of Top	Overall Width
CAB300-6	6"	N/A	1-3/8"	N/A	3"
CAB300-36	36"	11-1/2"	1-3/8"	2-5/8"	3"
CAB350-36	36"	8"	1-1/2"	2"	3-1/2"

*Cabriole Series is also available
in 36" & 6"
See Pages 113, 117, 156 & 183*

*Available in Alder, Cherry, Maple,
Poplar, Red Oak, & Rubberwood
Other Species upon request*

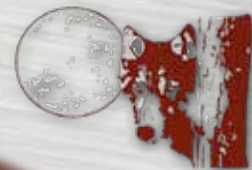

JEBELLA SERIES

QUEEN ANNE LEGS



HB1150
Shown in Picture



OVERALL WIDTH = 4 3/4"

HB1150

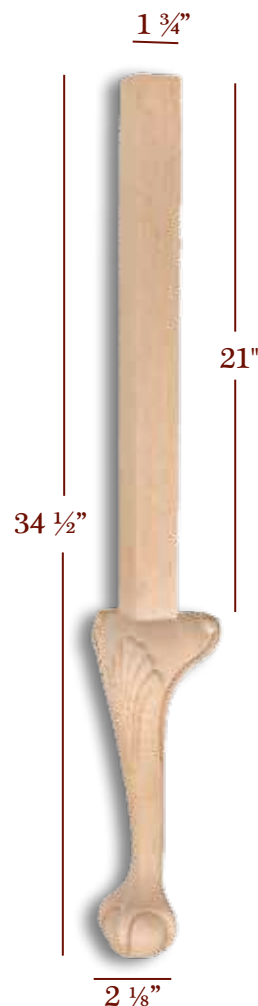

OVERALL WIDTH = 4 1/2"

HB1250

Cabriole & Queen Anne Legs

Item No.	Tall	Shank length	Toe	Width of Top
HB1150	34-1/2"	16"	2"	1-3/4"
HB1250	34-1/2"	21"	2-1/8"	1-3/4"

*Available in Alder, Cherry, Maple,
Red Oak & Rubberwood
Other Species upon request*

"Leading the Pack"

QUEEN ANNE SERIES

Cabriole & Queen Anne Legs

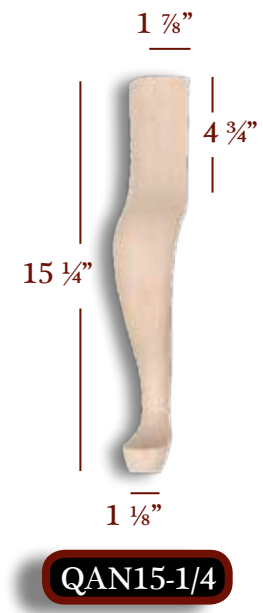
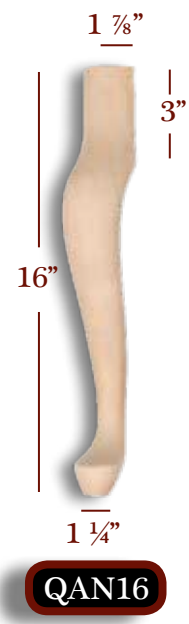
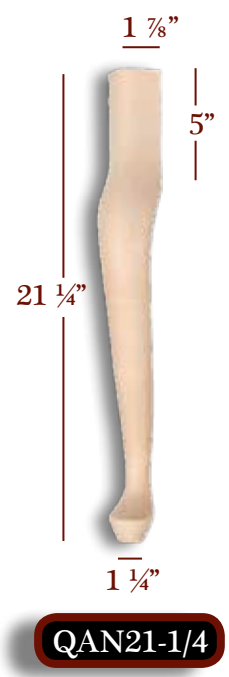
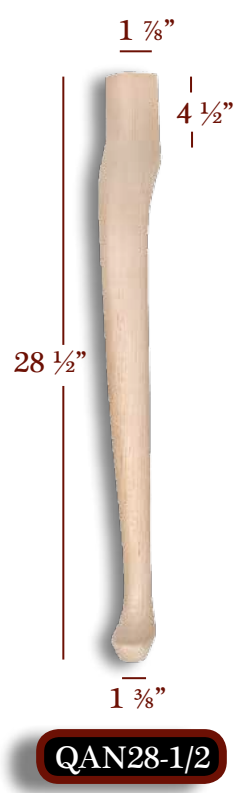
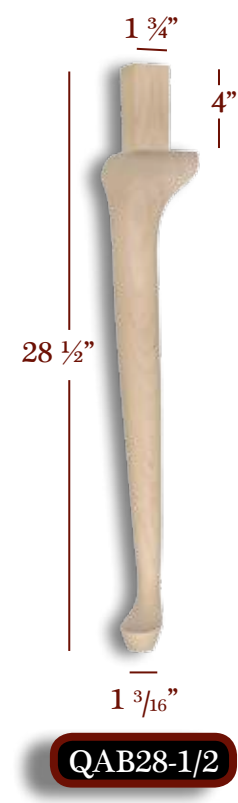
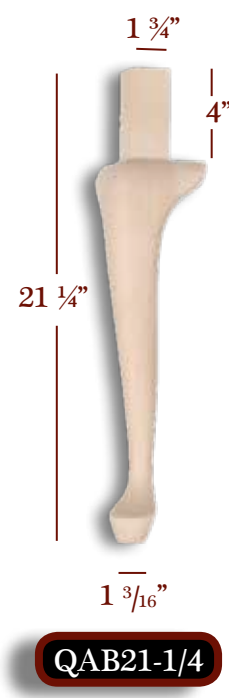

Item No.	Tall	Shank length	Toe	Width of Top
QAB17-1/4	17-1/4"	4"	1-5/16"	1-3/4"
QAB21-1/4	21-1/4"	4"	1-3/16"	1-3/4"
QAB28-1/2	28-1/2"	4"	1-3/16"	1-3/4"
QAN15-1/4	15-1/4"	4-3/4"	1-1/8"	1-7/8"
QAN16	16"	3"	1-1/4"	1-7/8"
QAN21-1/4	21-1/4"	5"	1-1/4"	1-7/8"
QAN28-1/2	28-1/2"	4-1/2"	1-3/8"	1-7/8"

Available in Alder, Cherry, Maple, Red Oak & Rubberwood
Other Species upon request

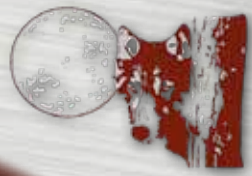

QUEEN ANNE SERIES

Cabriole & Queen Anne Legs



Item No.	Tall	Toe	Width of Top
QAB4	4"	1-1/16"	~3-1/4"
QAB5-1/2	5-1/2"	1-3/16"	~3-1/2"
QAB8-1/2	8-1/2"	1-3/8"	~3-1/2"
QAB10	10"	1-3/8"	~4"
QAB-BC-6	6"	1-5/8"	~3-7/8"
QAN-BC-6	6"	2"	~1-7/8"
QAN7-CP	7"	1-13/16"	2-3/8"
CAB300-6	6"	1-3/8"	3" Overall

Available in Alder, Cherry, Maple,
Red Oak & Rubberwood
Other Species upon request



EXTRA OPERATIONS



END TRIM - This operation cuts the leg down by removing inches from the shank to adjust the overall height of the post. Determined by customer.

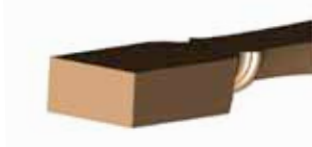

SPLITTING - This operation cuts the leg in half from the top down, producing two equal halves. When splitting legs or posts with windows, the front face only will be windowed.



DIAGONAL SPLIT - This operation cuts the leg in half from the top down from corner to corner.



PARTIAL NOTCH - This process removes one quarter of the post from the top down and stops 4" before reaching the bottom. This can be adjusted to fit your need.



FULL NOTCH - This operation removes one quarter of the post entirely.



QUARTERING - This operation cuts the leg from the top down, producing four equal pieces.



FINISHING - Finishing - call for custom quote and available finishes.



HANGER BOLT - This operation bores for and installs a hanger bolt in the product.

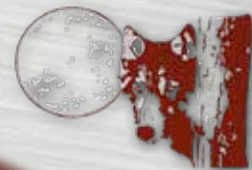

SPECIES AVAILABLE

STANDARD SPECIES - *Expected lead times are 2-5 days. Subject to change based on manufacturing requirements.*



ALDER - Classified as a hardwood, the wood is soft, white when first cut, turning to pale red which often looks similar to cherry. It is characterized by its straight closed grain and even texture. It takes stain well. Being rather light, soft and uniform in color, it can be easily worked.



CHERRY - Classified as a hardwood, the reddish-brown wood is hard, strong and heavy. Our cherry is 90%+ red with minimal to no sap. This wood sands and finishes beautifully, making it a highly desired species for the making of furniture and cabinetry.



MAPLE - This wood has medium density, strength and hardness. It is a light, closed grained, uniform in color species. Light greys and light browns may appear. No dark colors.



POPLAR - The soft, fine-grained species is considered a paint grade wood. Poplar, normally light in color, may have medium to light green color with no blacks or purple allowed.



RED OAK - This wood is known for being very heavy, strong, hard and coarse grained. Pale reddish brown in color. Uniform in color.



RUBBERWOOD - This is wood from the Pará rubber tree. Rubberwood is harvested only after it completes its latex producing cycle, generally when it is 25-30 years old. Rubberwood is advertised as an "environmentally friendly" wood, as it makes use of plantation trees that have already served a useful function. Rubberwood has a dense grain that is easily controlled in the kiln drying process. Uniform light brown in color, this species can be stained or painted.



WHITE PINE - The wood is a soft, lightweight wood. It has a straight grain and a fine even texture. White pine is creamy white or a pale straw color often having the characteristic solid pine knots.

PREMIUM SPECIES - *Expect extended lead times from 2-5 weeks. Call for estimate.*



HICKORY - The wood is very hard, dense and durable. The grain is normally straight, however sometime can be irregular or wavy. Hickory varies widely between color from reddish brown, white and lighter brown.



AFRICAN MAHOGANY - One of the most valued of the premium species in furniture and cabinetry. The wood has a characteristic grain and a medium coarse texture. It varies from medium red to light reddish brown. Uniform in color.



WHITE HARD MAPLE - The wood is a closed grain hard wood. The sapwood can be very white in color. Hard Maple is usually very consistent in color and uniform in accepting stains. A favorite of the stain grade species.



WHITE OAK - This wood is a straight grain, a medium coarse grain hardwood. White Oak is harder and heavier than Red Oak. It ranges in color from dark brown to light brown, lacking the reddish tones of the Red Oak. Because of the tighter, straighter grain pattern, a more consistent finish is accomplished.



WALNUT - Considered rare, Walnut is a valued favorite of the premium wood species. Very durable and strong, its naturally chocolate brown color and exquisite closed grain pattern sets it apart from all others. This wood finishes beautifully.

"Leading the Pack"



WE DO CUSTOM WORK

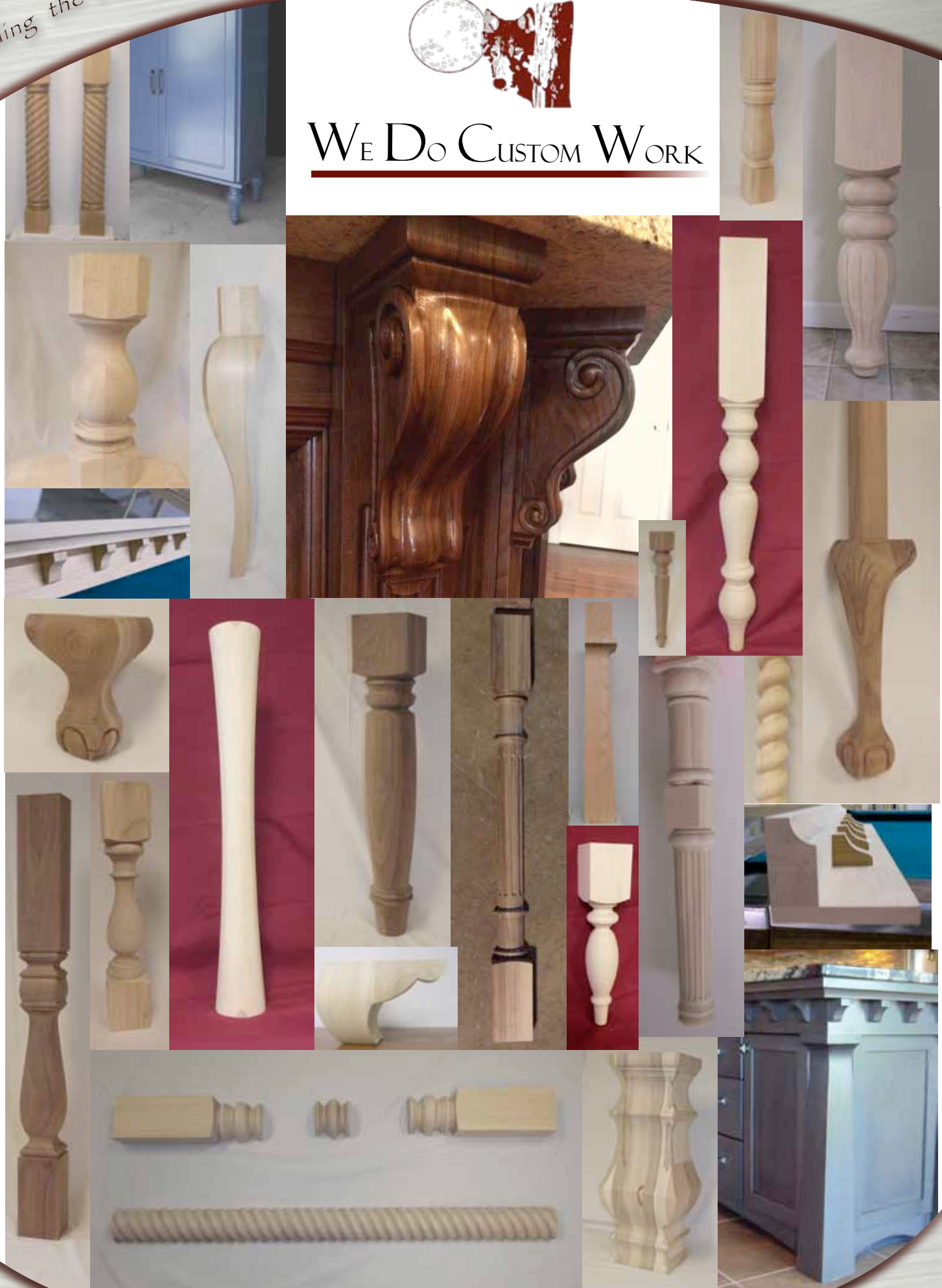

Custom Work

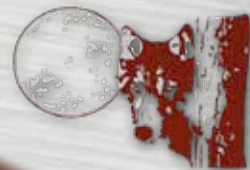

CUSTOM WORK CAPABILITIES

Timber Wolf Forest Products realizes that needs vary as much as personalities. Often times you find the part, but need it in a different size or species. Regardless of how simple or how complex your need, Timber Wolf is your one stop custom shop. Our expertise is here for your service. With no minimum quantities, Timber Wolf makes the custom experience easy. From your verbal description, picture, or hand drawing, we will render a professional drawing for your approval. From there we build the tooling, run the parts, and deliver the finished parts to your door. From design to delivery Timber Wolf can handle the job. While we offer more than 800+ items we recognize that custom is a necessity for some jobs.

Custom Work

DESIGN



DRAWING



DELIVERY

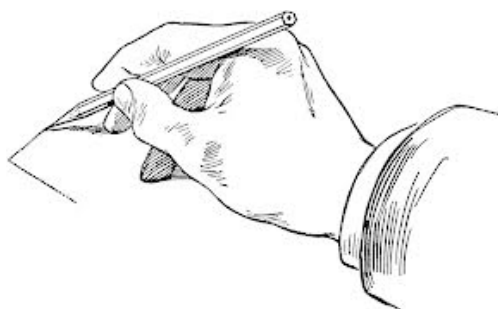

Phone: 877-504-WOLF
(9653)
sales@TimberWolfForest.com
www.TimberWolfForest.com

American Made

TIMBER WOLF FOREST PRODUCTS

"Leading the Pack"

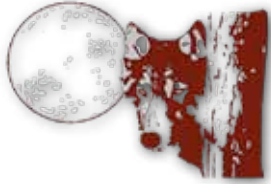

Email, Fax or Mail to:
sales@TimberWolfForest.com
Fax: 828-728-7554
P.O. Box 608
Hudson, NC 28638

ORDER FORM

Date: _____

Order Online: www.timberwolfforest.com
or
call us toll free at:
Phone: 877-504-WOLF
(9653)

Order Form

Billing Address:

Name: _____

Company Name: _____

Street Address/P.O. Box: _____

City: _____ State: _____

Zip: _____

Phone#: _____

Email: _____

Shipping Address:

Please check if Residence

Name: _____

Company Name: _____

Street Address/P.O. Box: _____

City: _____ State: _____

Zip: _____

Phone#: _____

Fax#: _____

Page	Quantity	Item Number	Species	Description	Unit Price	Extended Price
Special Instructions:					SUBTOTAL	
					Shipping, Packing, Insurance & Handling, (to be applied upon Shipping)	
					Inquire for Next Day Delivery and 2nd Day Delivery	
					TOTAL	

Payment Method:

Mastercard Visa American Express Discover

Card#

CVV#

Expiration Date

Print Name as it appears on the Card

X
Authorized Signature

INDEX BY SERIES NAME

Acanthus Series - 31000	Pages 6, 9, 18-19, 102-103, 109-111, 114
Bar Bracket Series - BB	Pages 4-5, 92-101
Bellington Series - 24000	Pages 20-21, 114
Branson Series - 8000C	Pages 22-25, 115-116
Cabinet & Furniture Bun Feet - BF	Pages 14-16, 145-156
Cabriole Series - CAB	Pages 117, 158, 182-184
Cathedral Series - CP	Pages 118, 142, 147
Charleston Series - 14000	Pages 26-27, 119, 159
Corbel Series - CBL	Pages 6-9, 93, 102-108
Cosmo Series - 3000	Pages 28-29, 120, 160-162
Dellinger Series - 10000	Pages 30-31, 121, 163
Dillon Series - 27000	Pages 32-33, 121
Ellis Series - 28000	Pages 34-35, 122
Empire Series - 18000	Pages 36-37, 122
Essential Series - TW	Pages 38-39, 123
Franklin Series - 34000	Pages 40-41, 123
Georgian Series - 41000	Pages 42-43, 124, 143
Hamilton Series - 4000	Pages 44-45, 124, 164-166
Harvest Series - 2000	Pages 46-47, 125, 167-170
Jamestown Series - 1000	Pages 48-49, 126, 171
Jebella Series - HB	Pages 144, 185
Kimerick Series - 30000	Pages 50-51, 126
Kingston Series - 5000	Pages 52-53, 127, 172
Lakeland Series - 38000	Pages 54-55, 127
Liberty Series - 40000	Pages 56-57, 128
Lincoln Series - 6000	Pages 58-59, 129, 143, 173-175
Livingston Series - 17000	Pages 60-61, 129
Madera Series - PFP	Pages 148
Madison Series - 8000	Pages 62-63, 130
Mission Series - 22000	Pages 8, 64-65, 104-105, 131
Monaco Series - 21000	Pages 66-67, 132
Monte Cristo Series - 11000	Pages 68-69, 132, 176-177
Monterey Series - PFP	Pages 148
Onlay Series - ONL	Pages 109-111
Plinth Block Series - PB	Pages 111
Queen Anne Series - QA	Pages 186-187
Rochester Series - 32000	Pages 70-71, 133
Roosevelt Series - 36000	Pages 72-73, 133
Rosette Series - R	Pages 109, 111
Salem Series - 19000	Pages 74-75, 134, 178
Santa Fe Series - 20000	Pages 76-77, 135, 179
Savannah Series - 7000	Pages 78-79, 136, 180
Shaker Series - 98000	Pages 80-81, 137
Skyline Series - 99000	Pages 82-83, 137
Truman - 42000	Pages 138, 143
Vanderbilt Series - 16000	Pages 84-85, 138
Vanity Series - HB	Pages 141-144
Victoria Series - 15000	Pages 86-87, 139
Williamsburg Series - 12000	Pages 88-89, 140
Winston Series - 9000	Pages 90-91, 140, 143, 181

Mission Statement & About Us..	Page 2
Table of Contents	Page 3
Extra Operations	Page 188
Custom Work	Page 190-191
Notes	Page 192
Order Form	Pages 193
Index By Series Name & Index By Series Number	Page 194-195

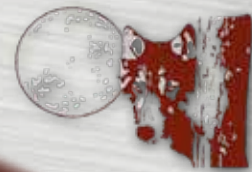

INDEX BY SERIES NUMBER

Jamestown Series - 1000	Pages 48-49, 126, 171
Harvest Series - 2000	Pages 46-47, 125, 167-170
Cosmo Series - 3000	Pages 28-29, 120, 160-162
Hamilton Series - 4000	Pages 44-45, 124, 164-166
Kingston Series - 5000	Pages 52-53, 127, 172
Lincoln Series - 6000	Pages 58-59, 129, 143, 173-175
Savannah Series - 7000	Pages 78-79, 136, 180
Branson Series - 8000C	Pages 22-25, 115-116
Madison Series - 8000	Pages 62-63, 130
Winston Series - 9000	Pages 90-91, 140, 143, 181
Dellinger Series - 10000	Pages 30-31, 121, 163
Monte Cristo Series - 11000	Pages 68-69, 132, 176-177
Williamsburg Series - 12000	Pages 88-89, 140
Charleston Series - 14000	Pages 26-27, 119, 159
Victoria Series - 15000	Pages 86-87, 139
Vanderbilt Series - 16000	Pages 84-85, 138
Livingston Series - 17000	Pages 60-61, 129
Empire Series - 18000	Pages 36-37, 122
Salem Series - 19000	Pages 74-75, 134, 178
Santa Fe Series - 20000	Pages 76-77, 135, 179
Monaco Series - 21000	Pages 66-67, 132
Mission Series - 22000	Pages 8, 64-65, 104-105, 131
Bellington Series - 24000	Pages 20-21, 114
Dillon Series - 27000	Pages 32-33, 121
Ellis Series - 28000	Pages 34-35, 122
Kimerick Series - 30000	Pages 50-51, 126
Acanthus Series - 31000	Pages 6, 9, 18-19, 102-103, 109-111, 114
Rochester Series - 32000	Pages 70-71, 133
Franklin Series - 34000	Pages 40-41, 123
Roosevelt Series - 36000	Pages 72-73, 133
Lakeland Series - 38000	Pages 54-55, 127
Liberty Series - 40000	Pages 56-57, 128
Georgian Series - 41000	Pages 42-43, 124, 143
Truman - 42000	Pages 138, 143
Shaker Series - 98000	Pages 80-81, 137
Skyline Series - 99000	Pages 82-83, 137
Bar Bracket Series - BB	Pages 4-5, 92-101
Cabinet & Furniture Bun Feet - BF	Pages 14-16, 145-156
Cabriole Series - CAB	Pages 117, 158, 182-184
Corbel Series - CBL	Pages 6-9, 93, 102-108
Cathedral Series - CP	Pages 118, 142, 147
Jebella Series - HB	Pages 144, 185
Vanity Series - HB	Pages 141-144
Onlay Series - ONL	Pages 109-111
Plinth Block Series - PB	Pages 111
Madera Series - PFP	Pages 148
Monterey Series - PFP	Pages 148
Queen Anne Series - QA	Pages 186-187
Rosette Series - R	Pages 109, 111
Essential Series - TW	Pages 38-39, 123

Mission Statement & About Us..	Page 2
Table of Contents	Page 3
Extra Operations	Page 188
Custom Work	Page 190-191
Notes	Page 192
Order Form	Pages 193
Index By Series Name & Index By Series Number	Page 194-195

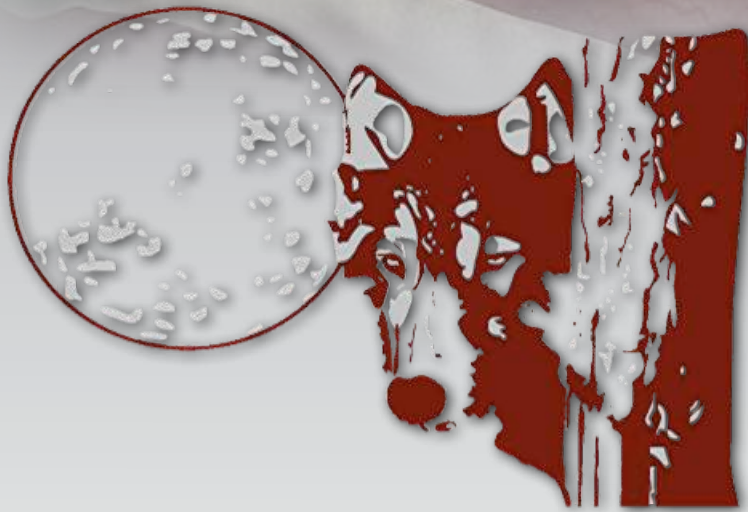

TIMBER WOLF

FOREST PRODUCTS

"Leading the Pack"

"I CAN DO ALL THINGS THROUGH CHRIST WHO STRENGTHENS ME".
PHILIPPIANS 4:13

P. O. BOX 608 ~ 3189 FREEZER LOCKER ROAD ~ HUDSON, NC 28638

sales@TimberWolfForest.com • www.TimberWolfForest.com • Phone: 877-504-WOLF
(9653)